

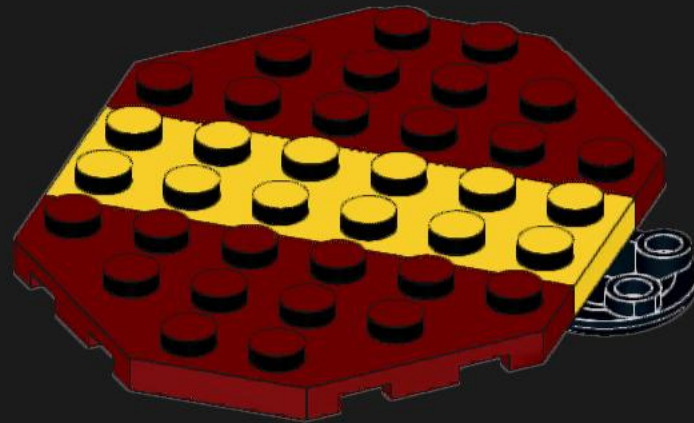

1

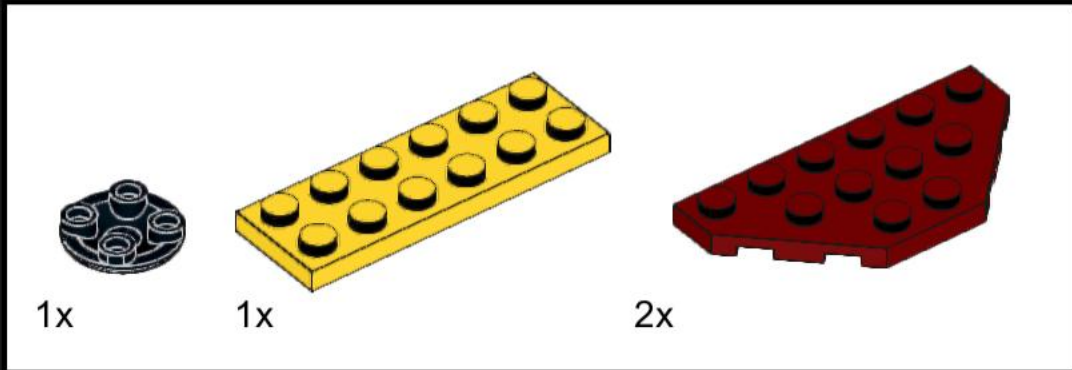

2

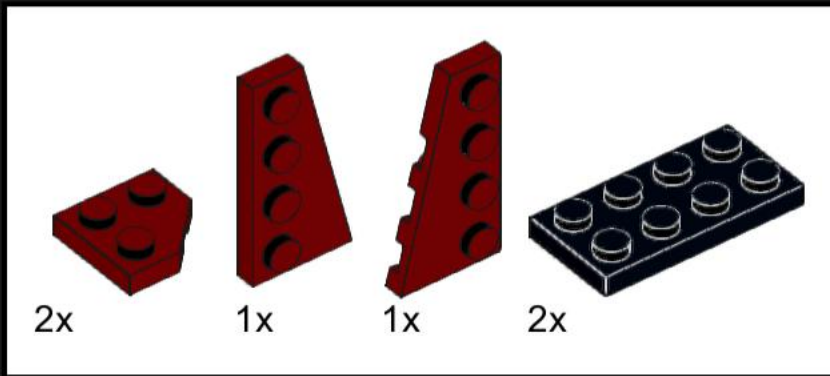

3

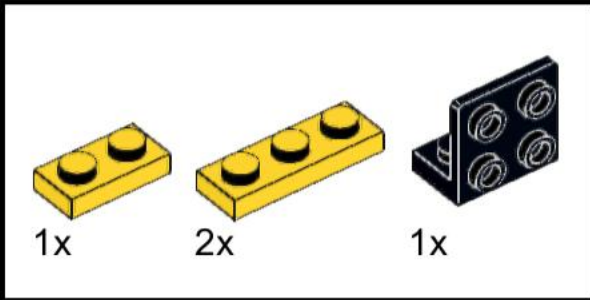



4

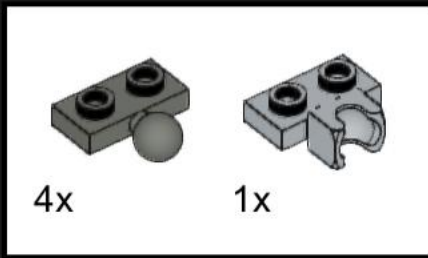

5

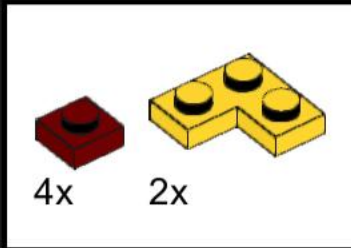

6

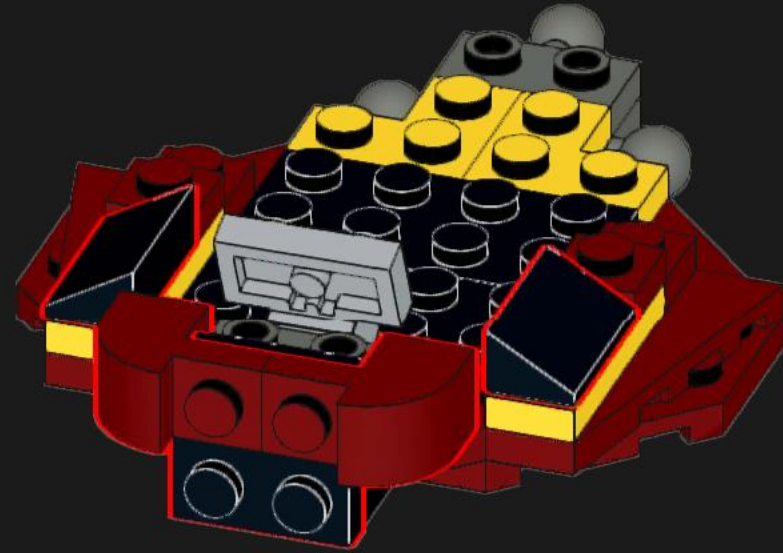
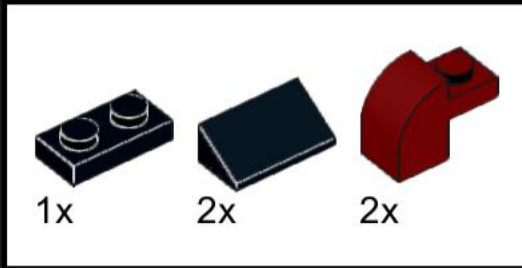

7

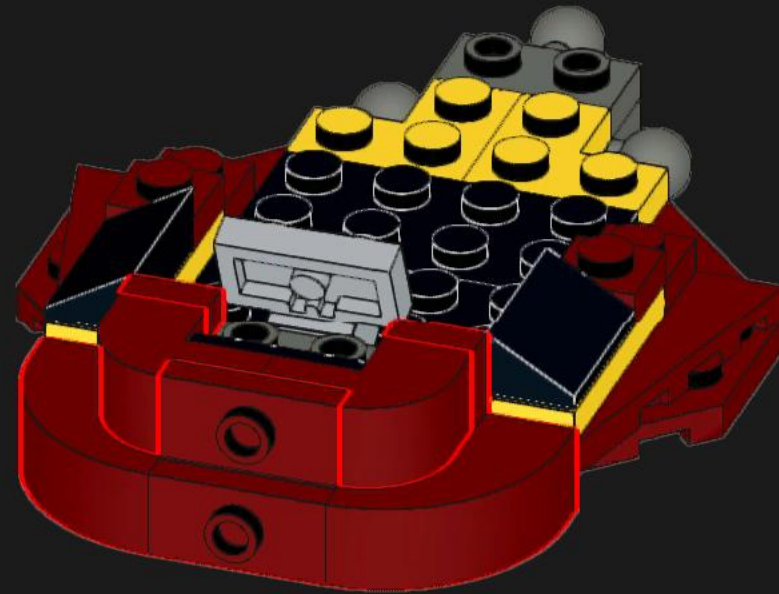
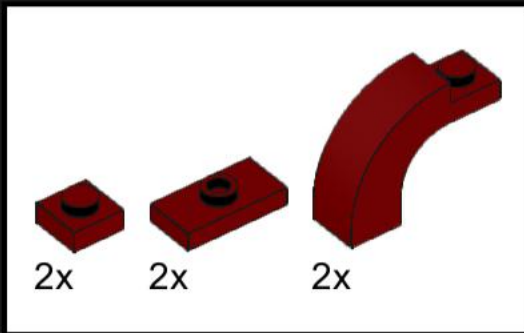



8

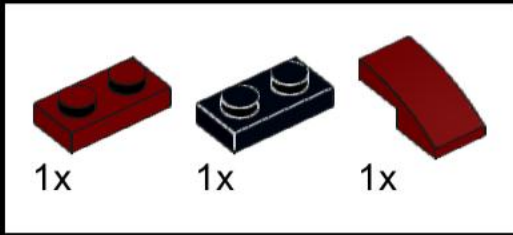

9

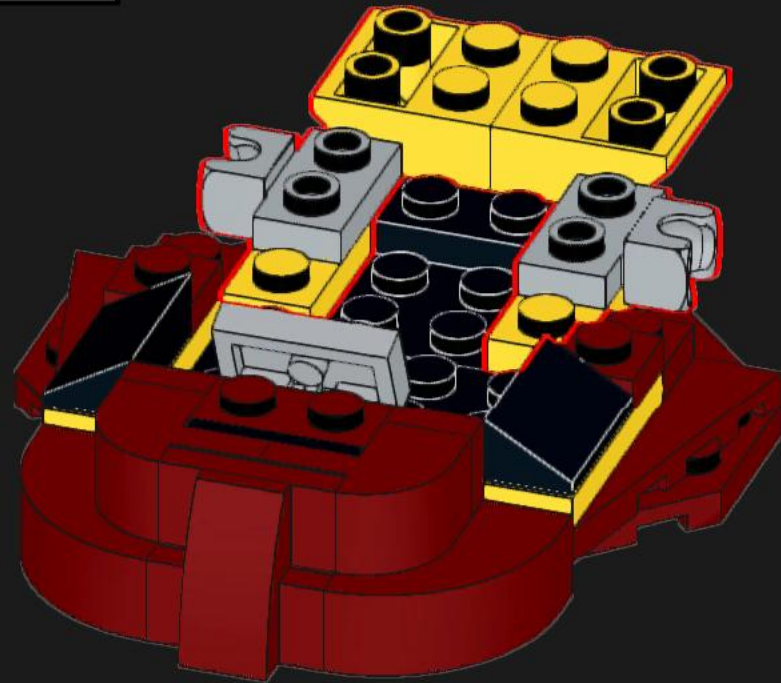
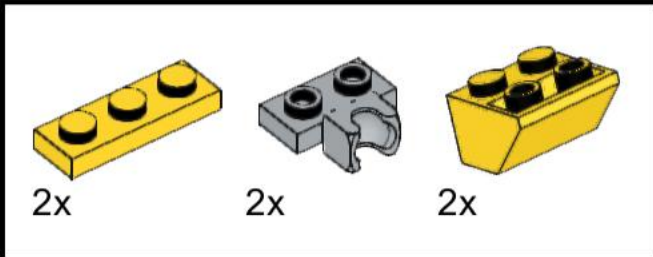

10

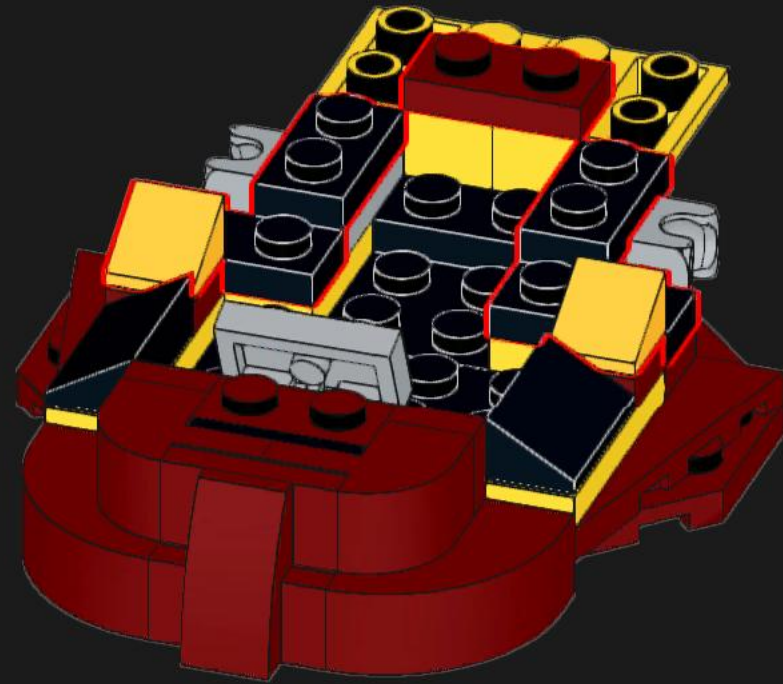
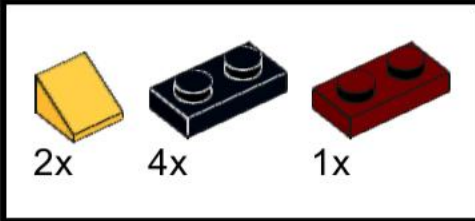

11

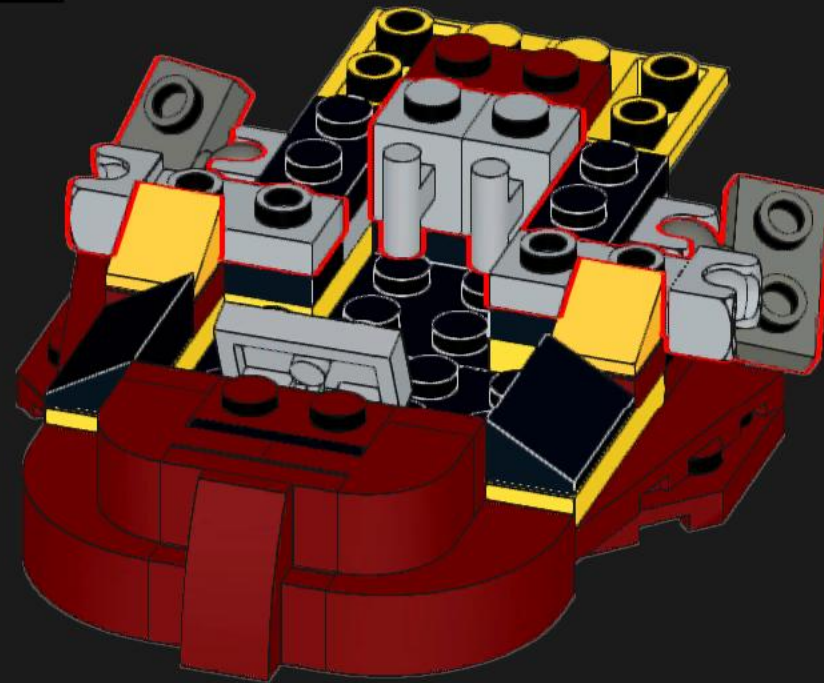
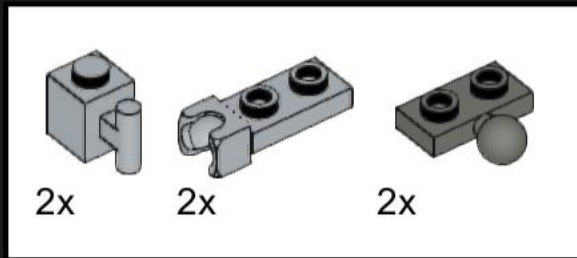

12

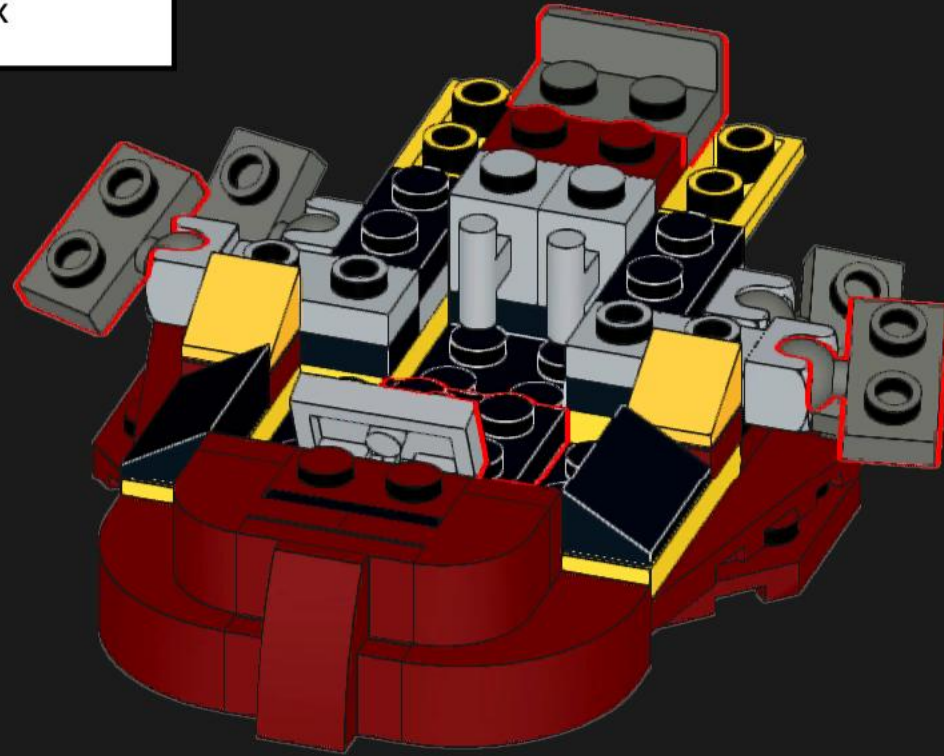
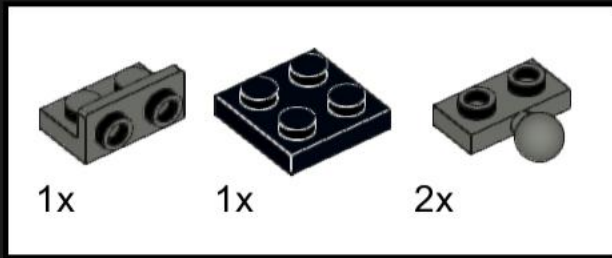



13

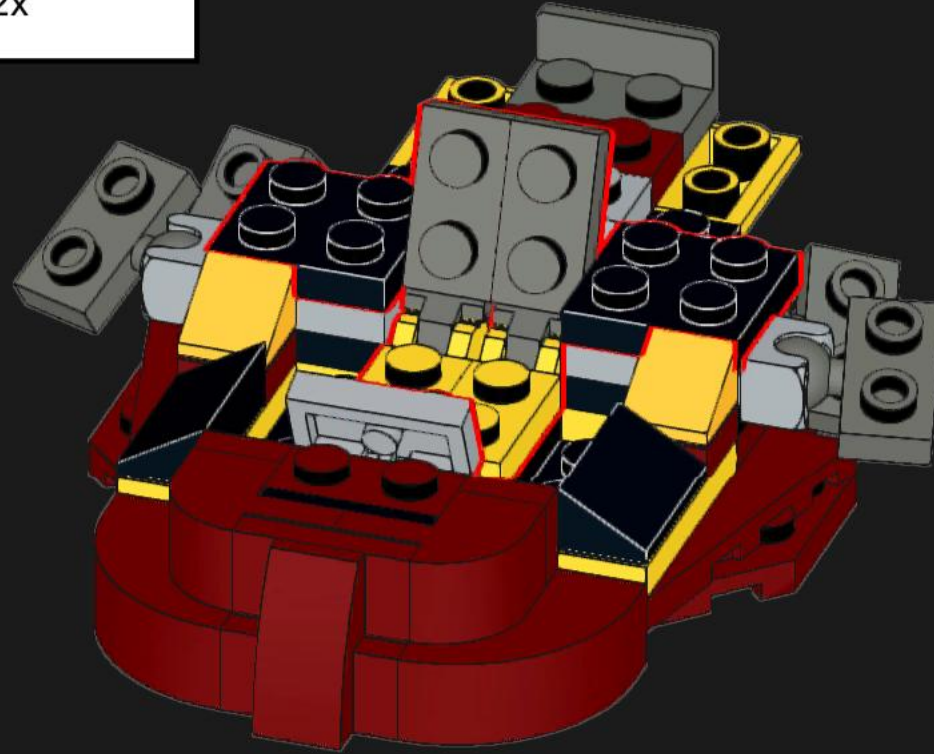
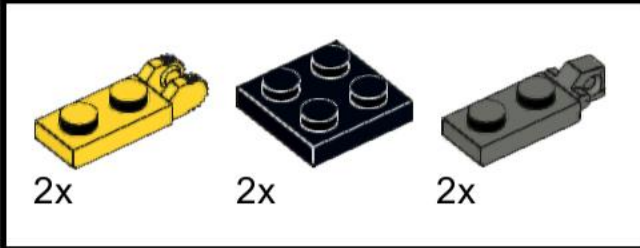

14

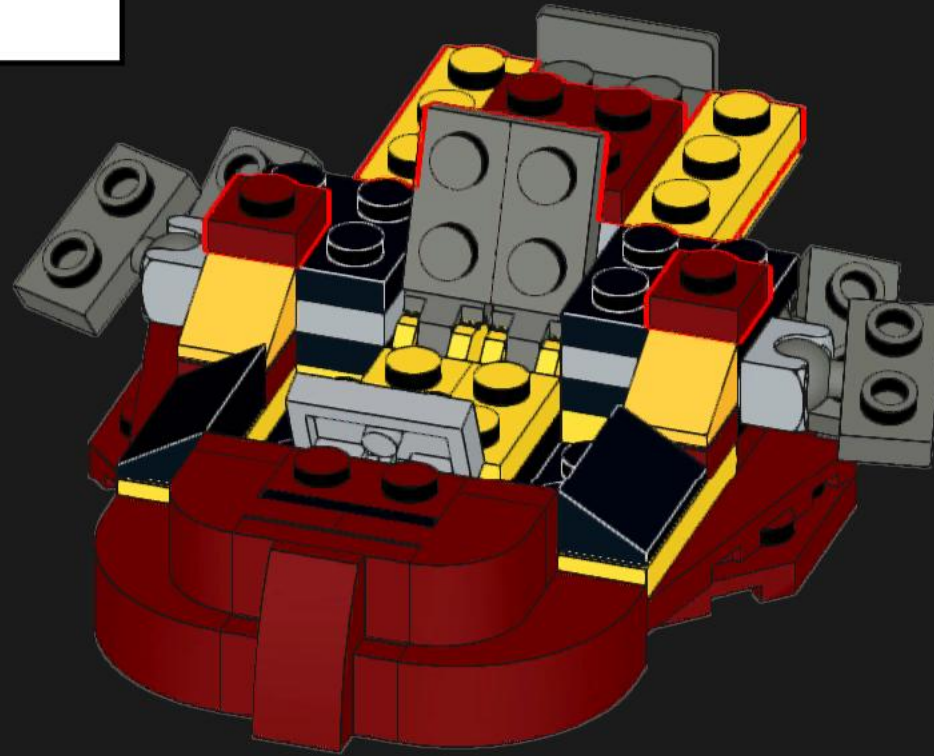
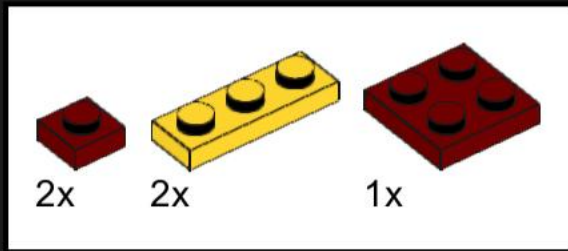

15

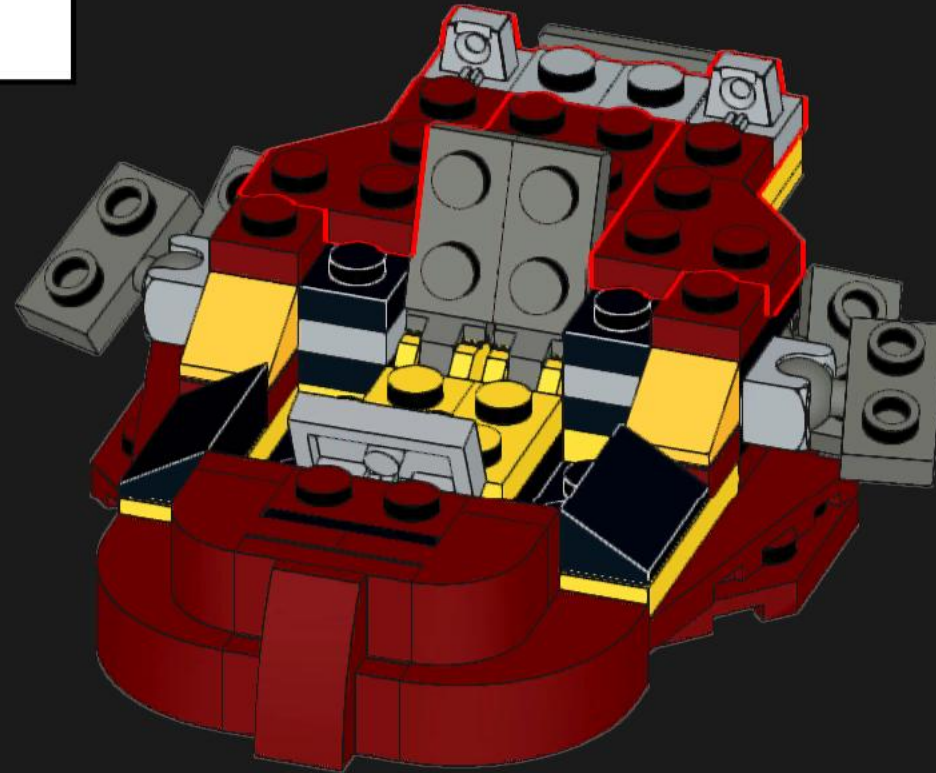
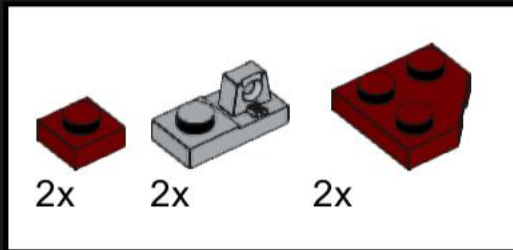

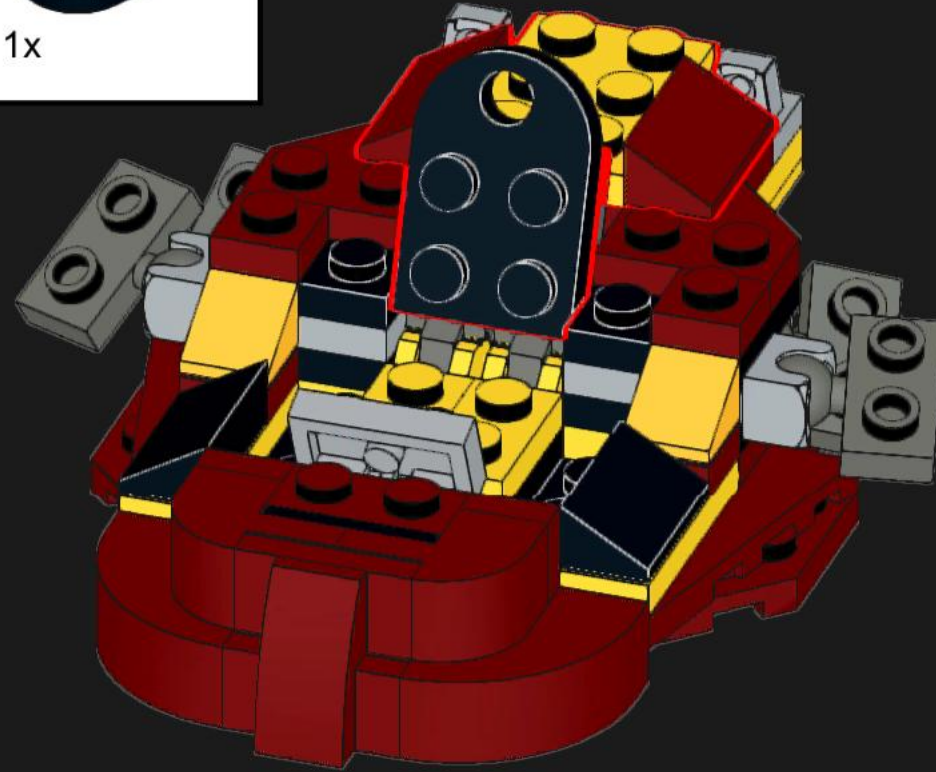
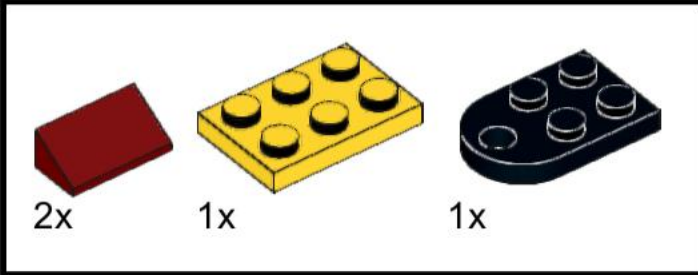

17

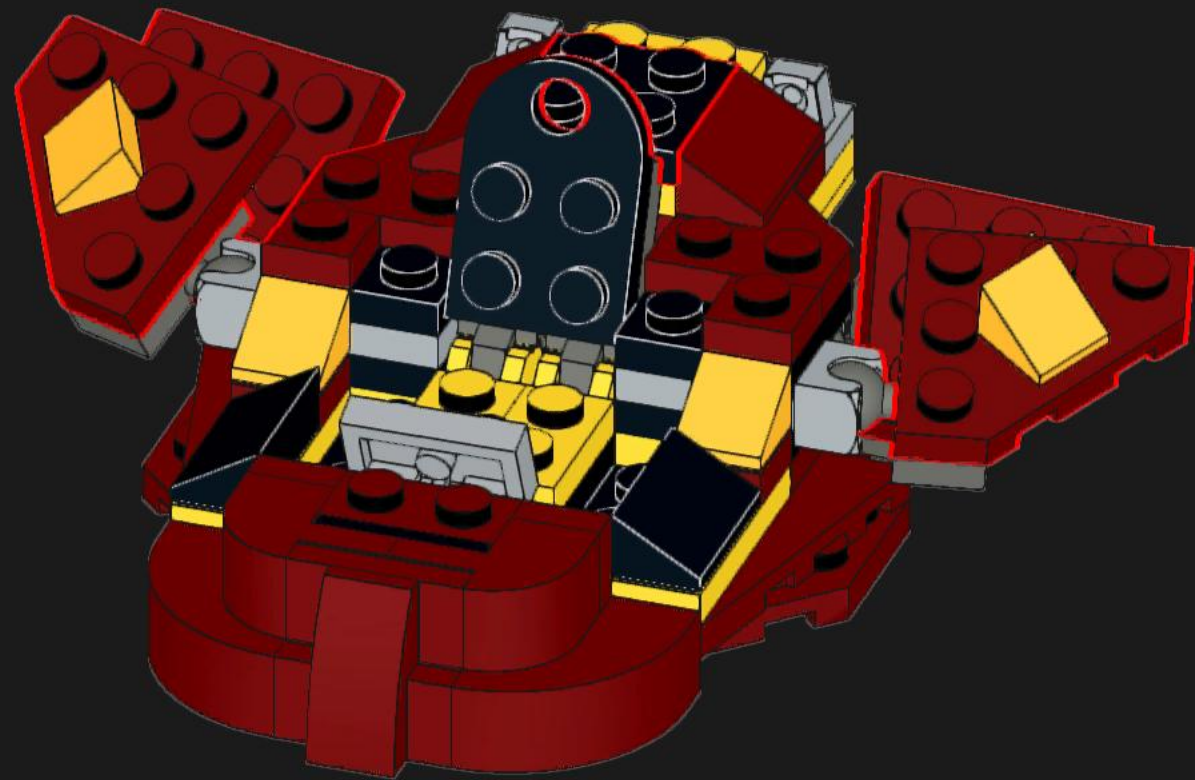
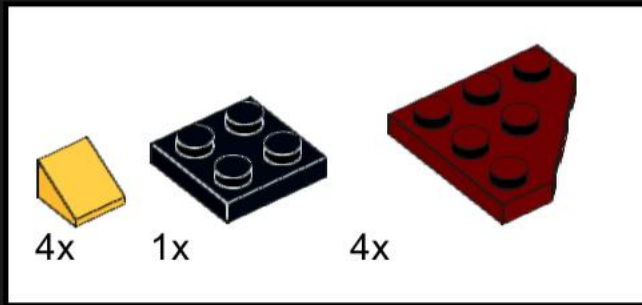



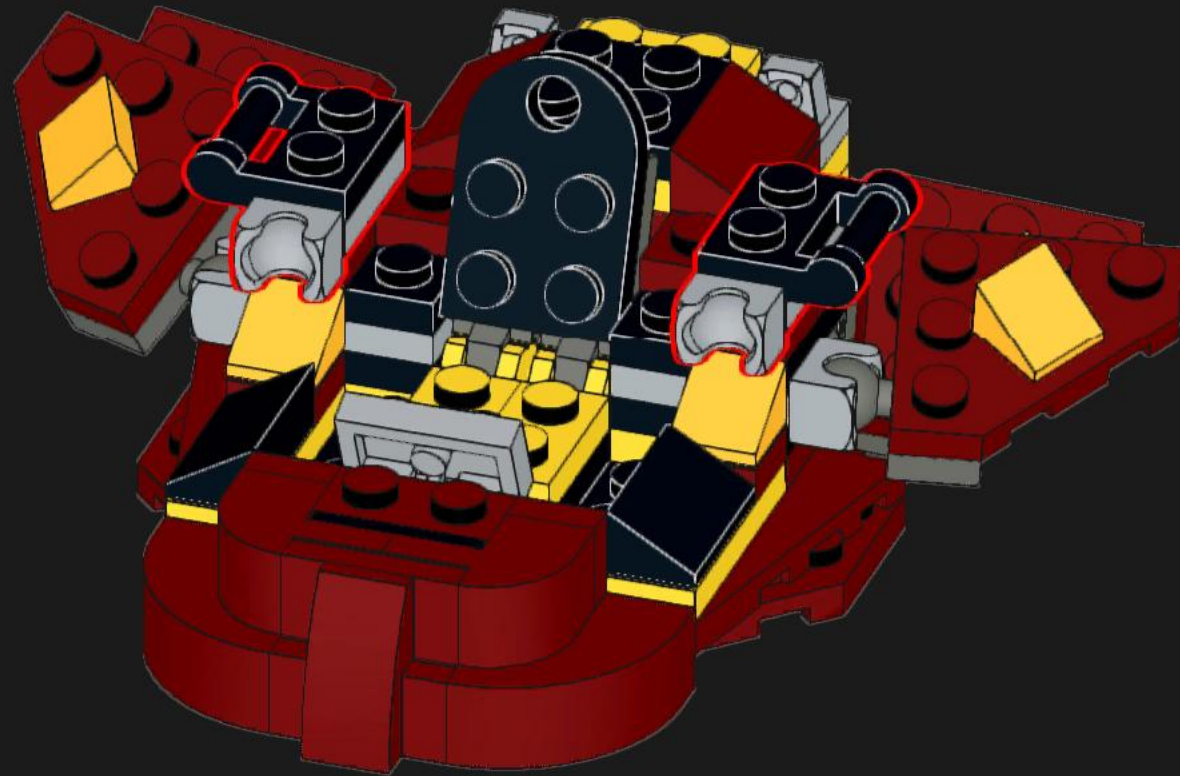
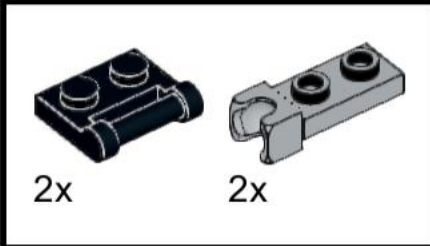

19

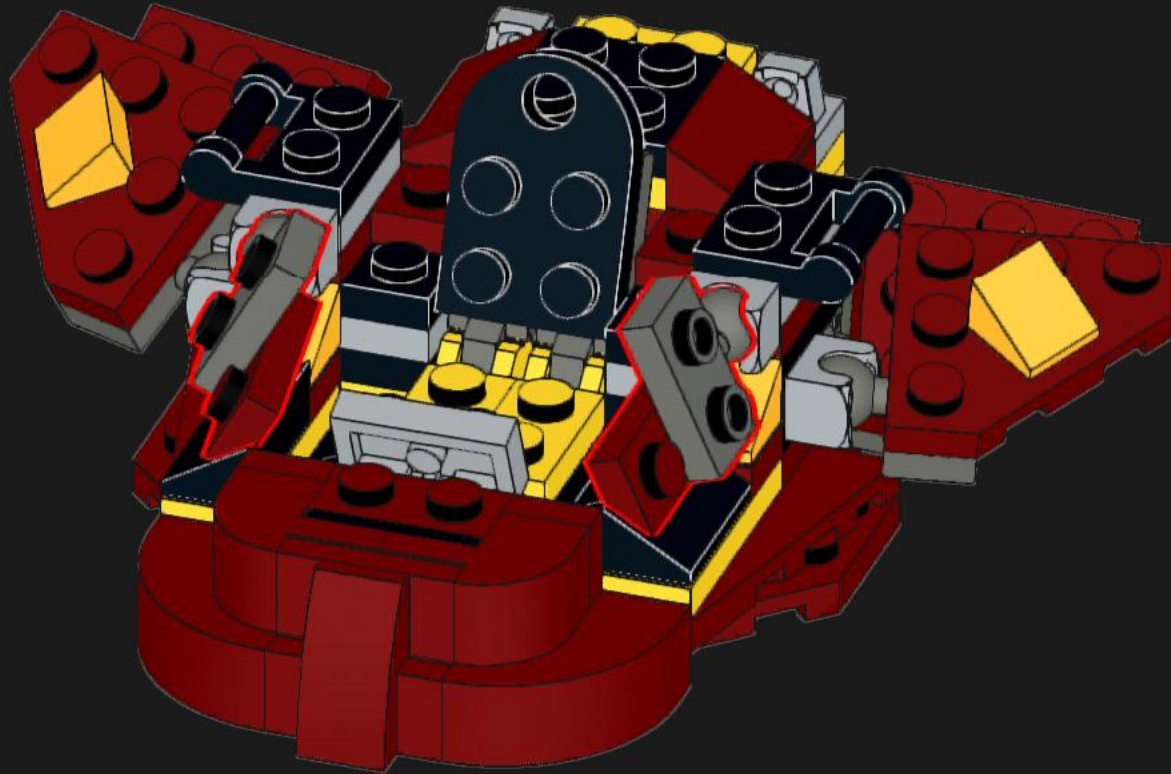
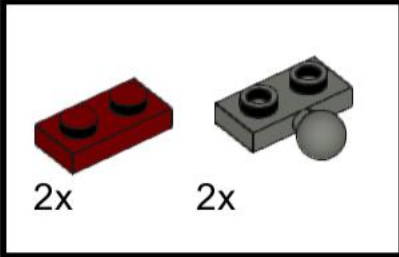

20

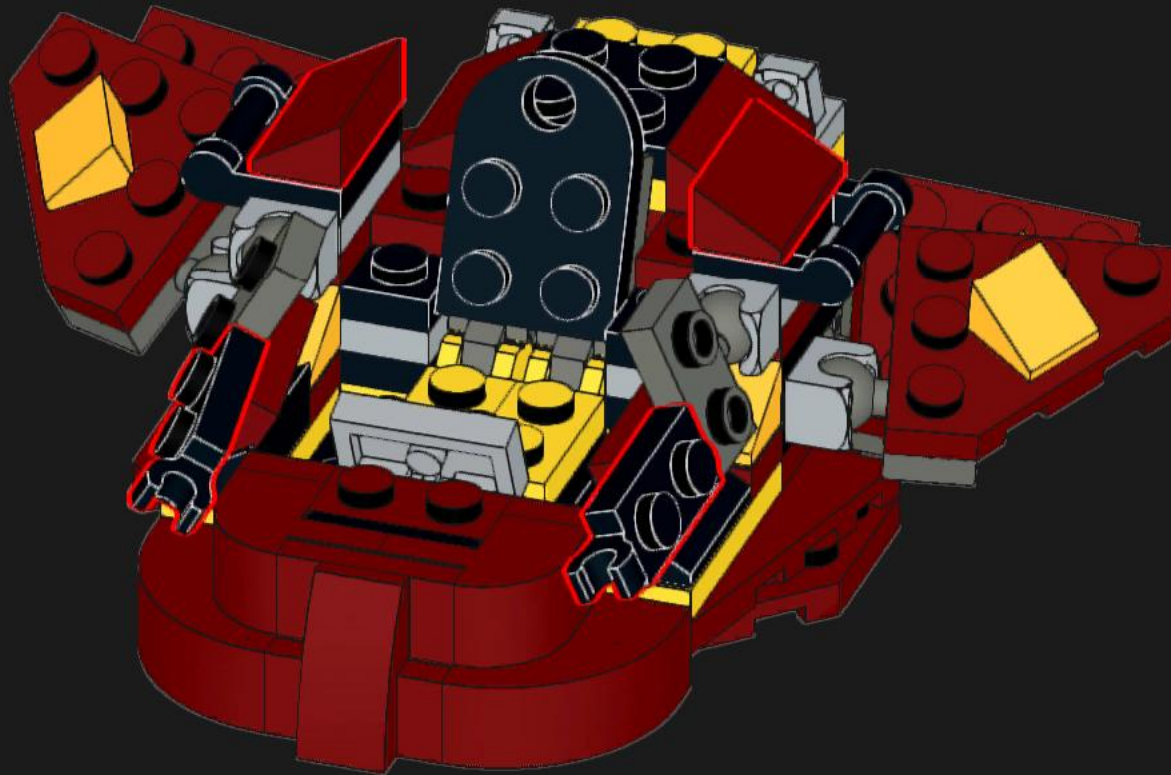
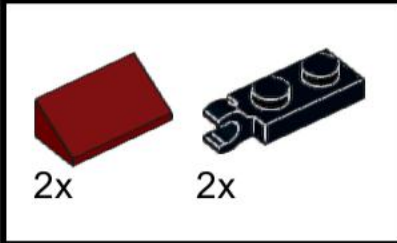

21

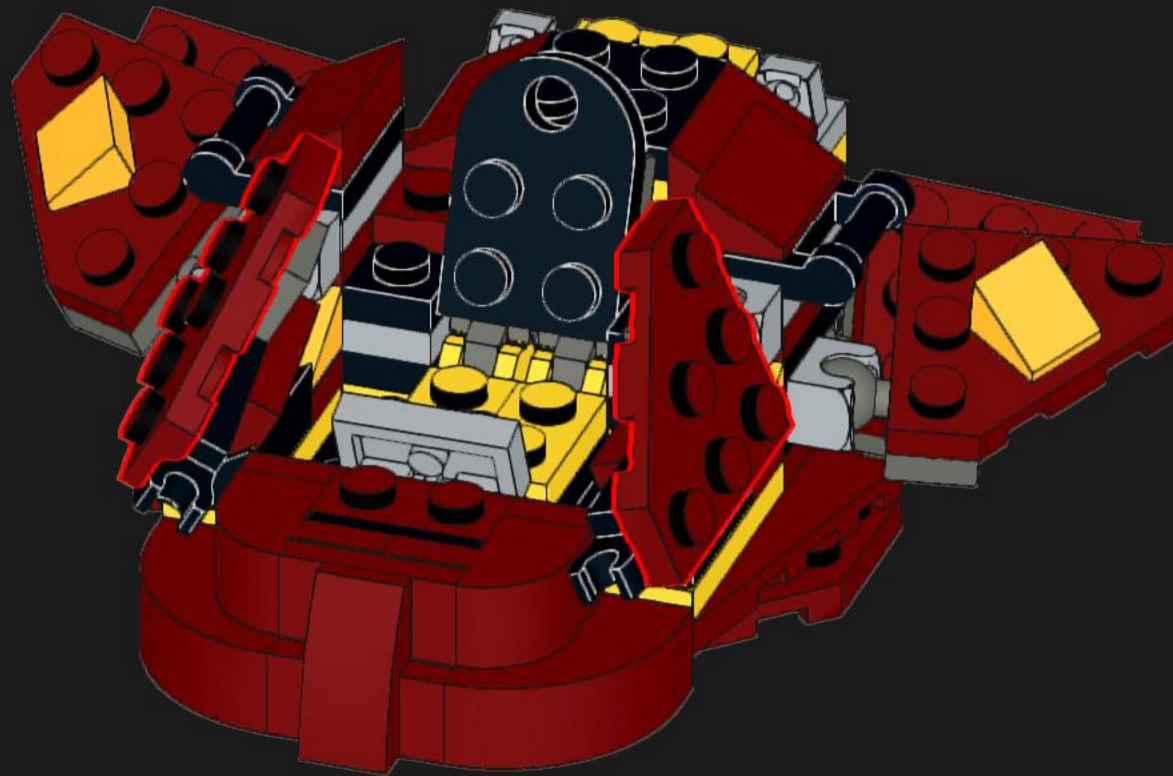
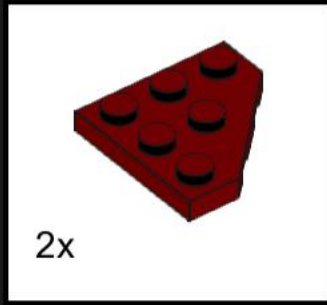



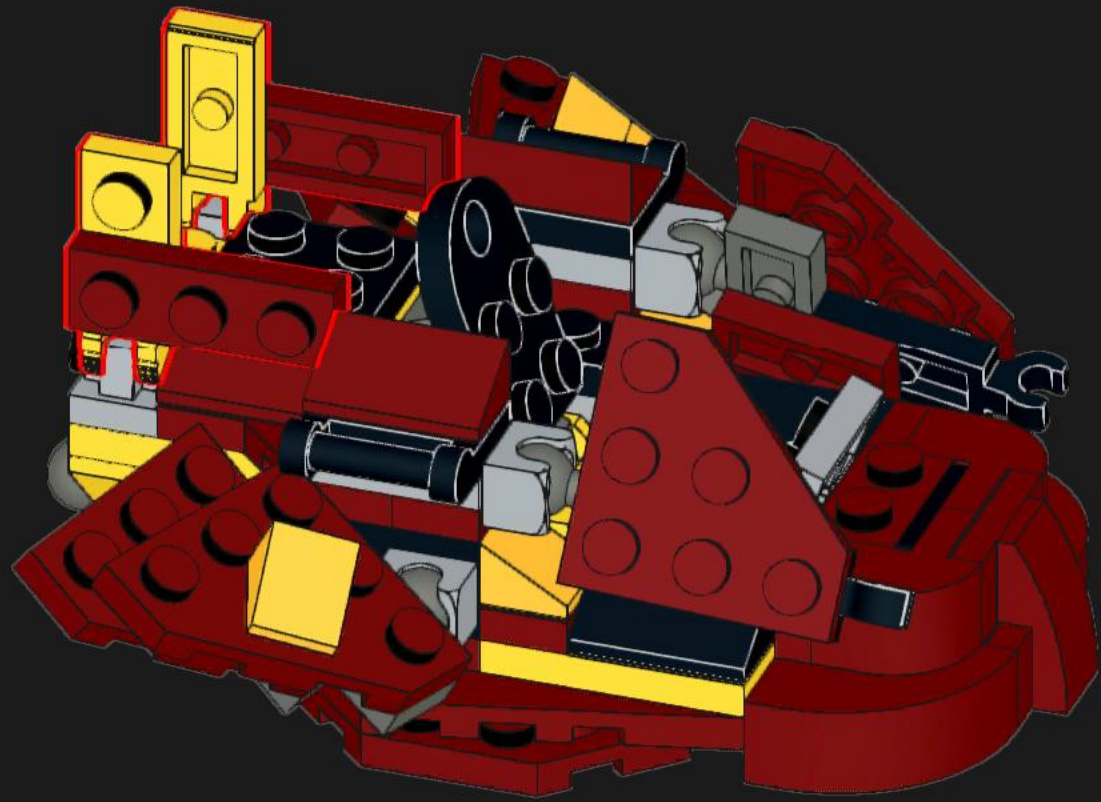
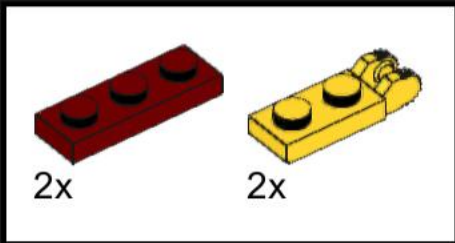



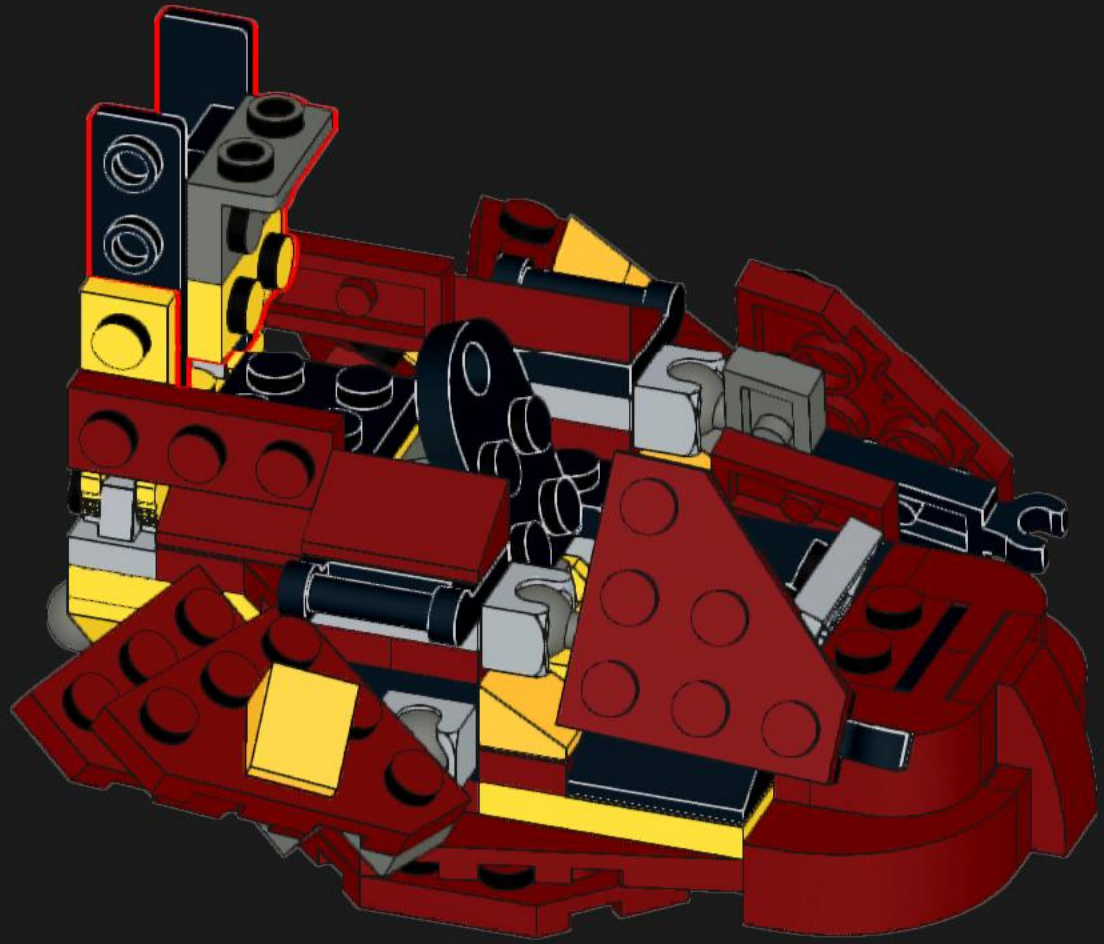
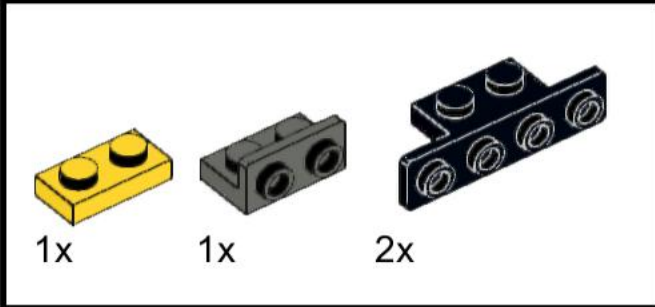

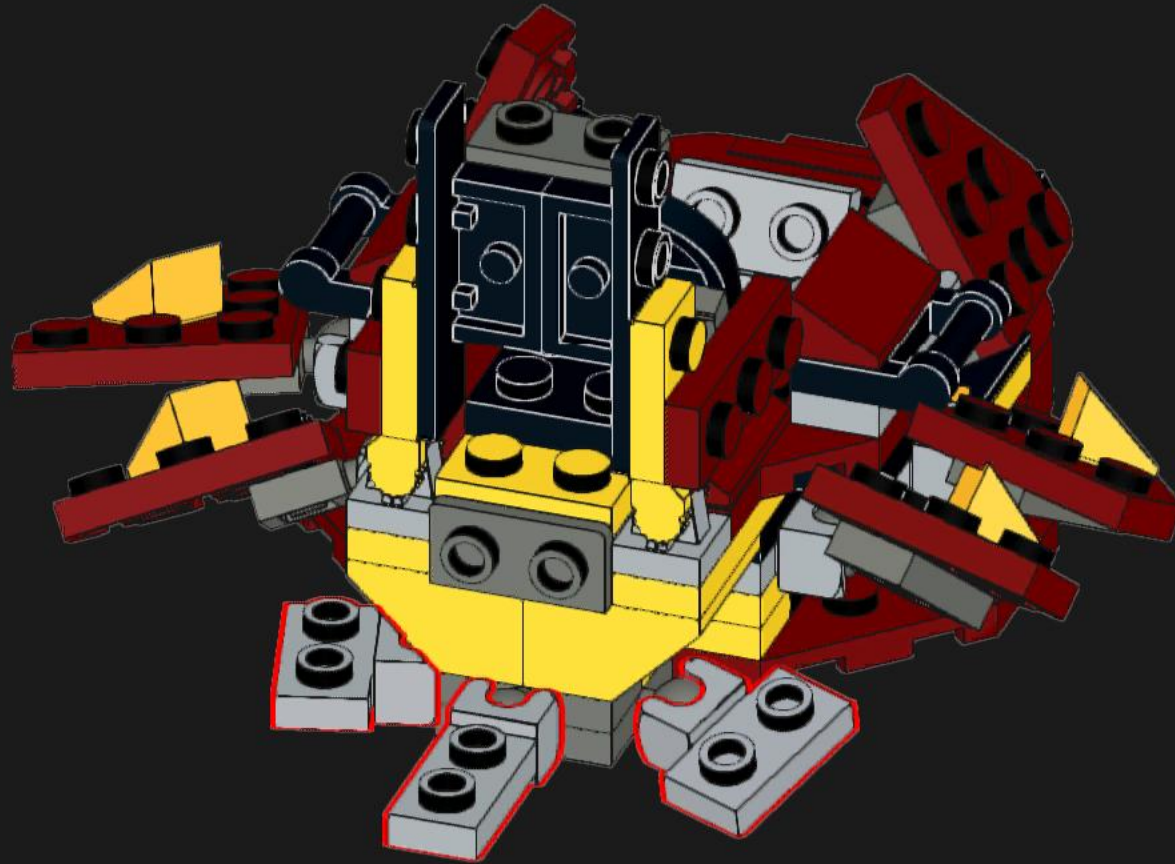
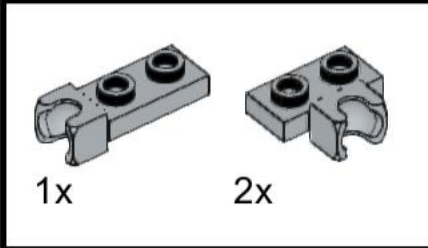

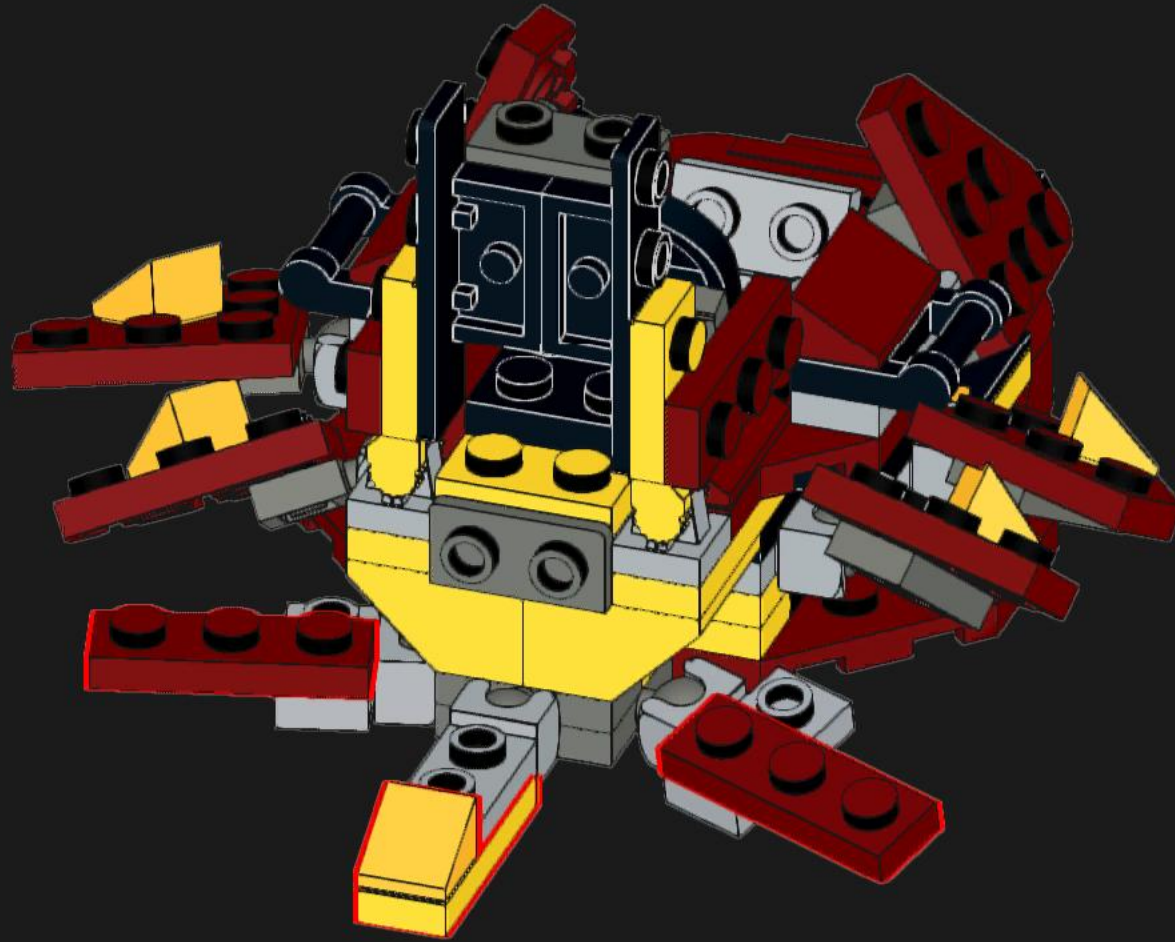
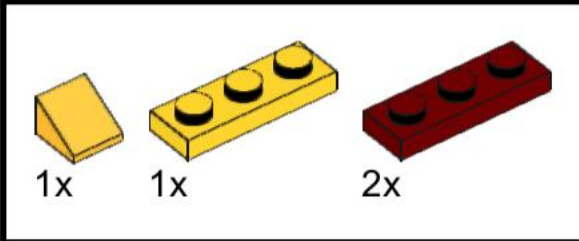

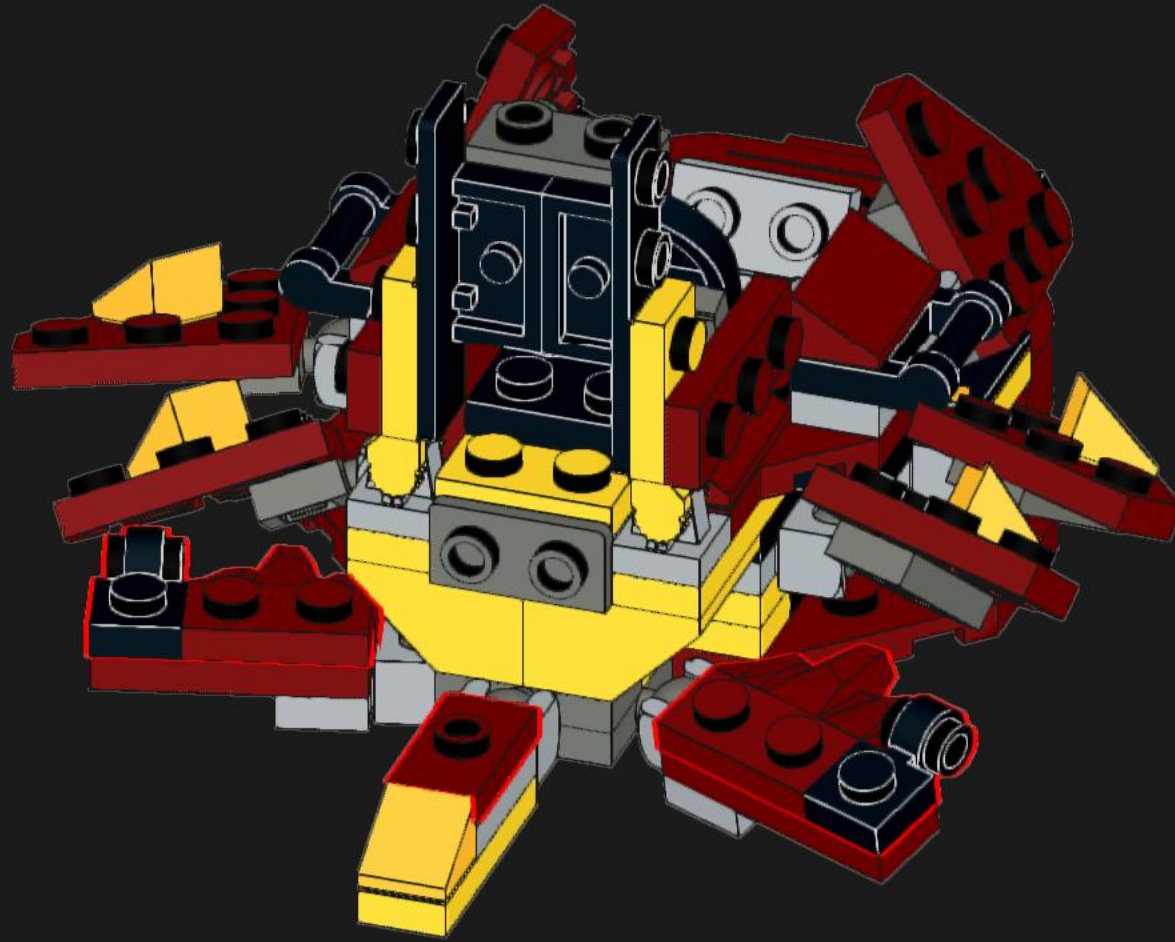
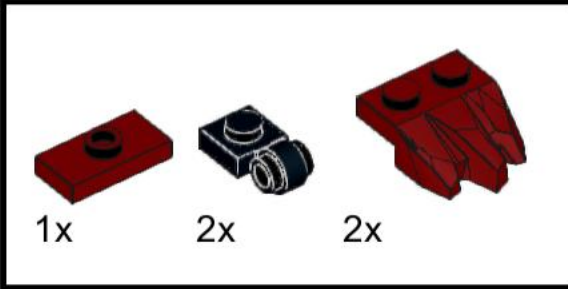



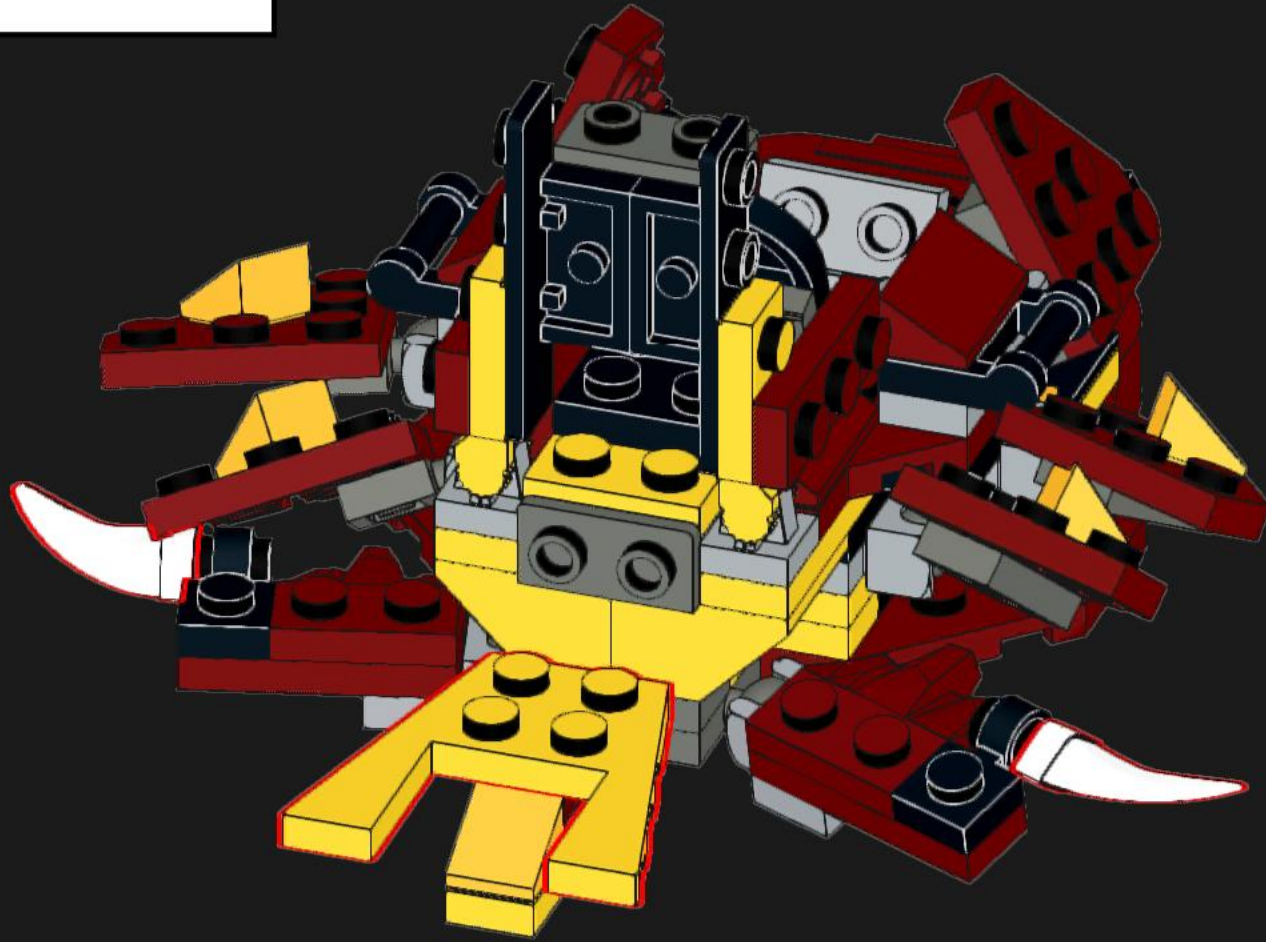
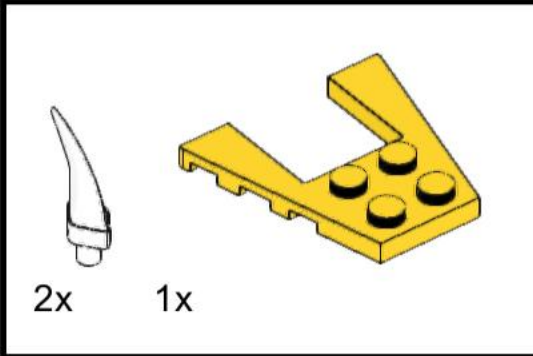



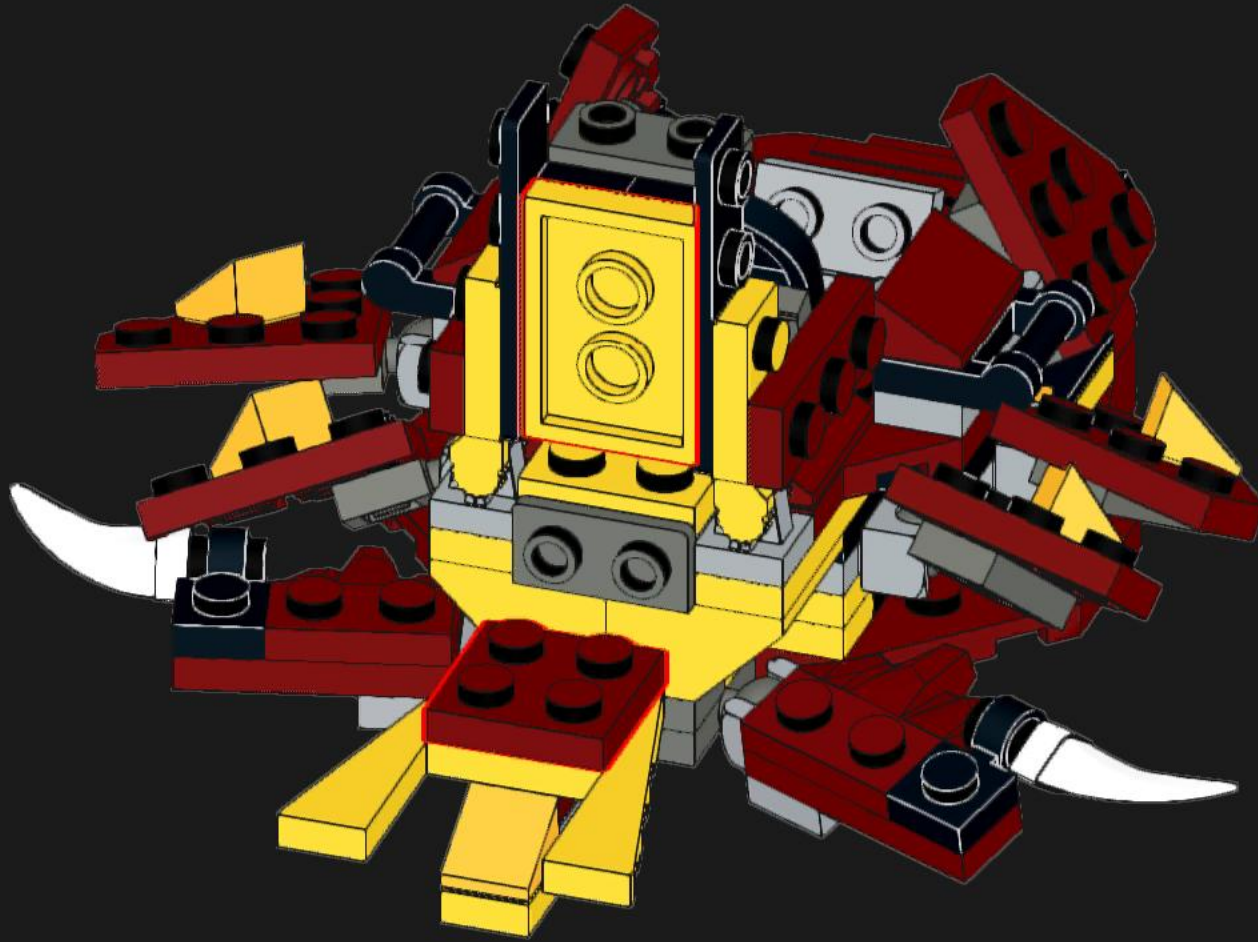
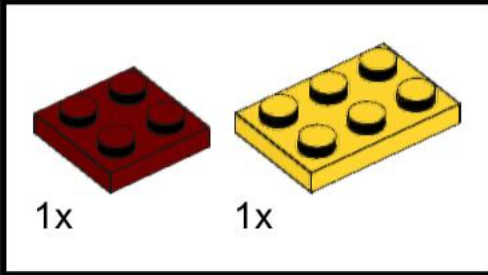

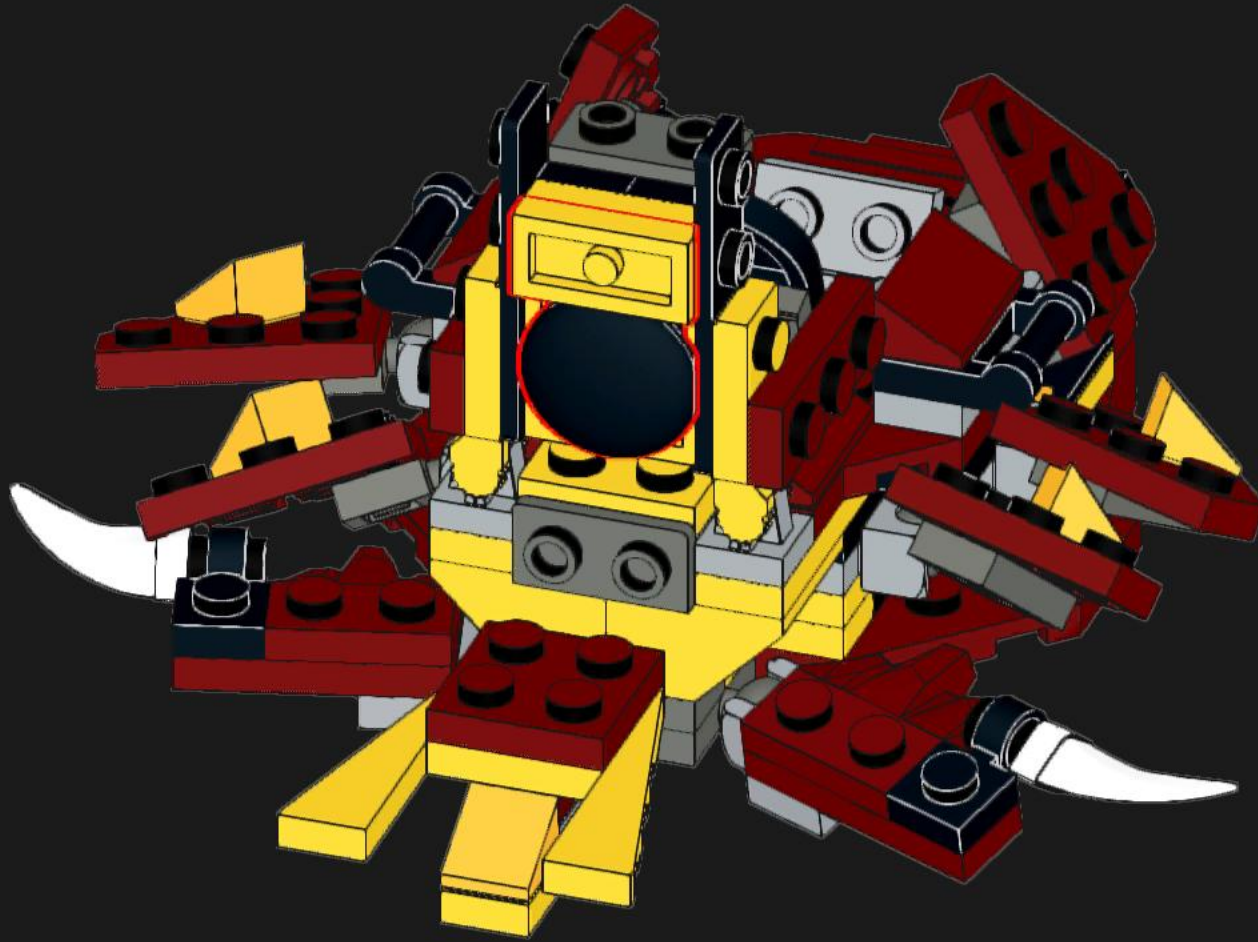
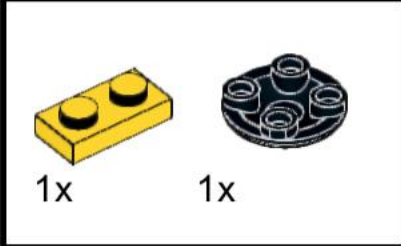

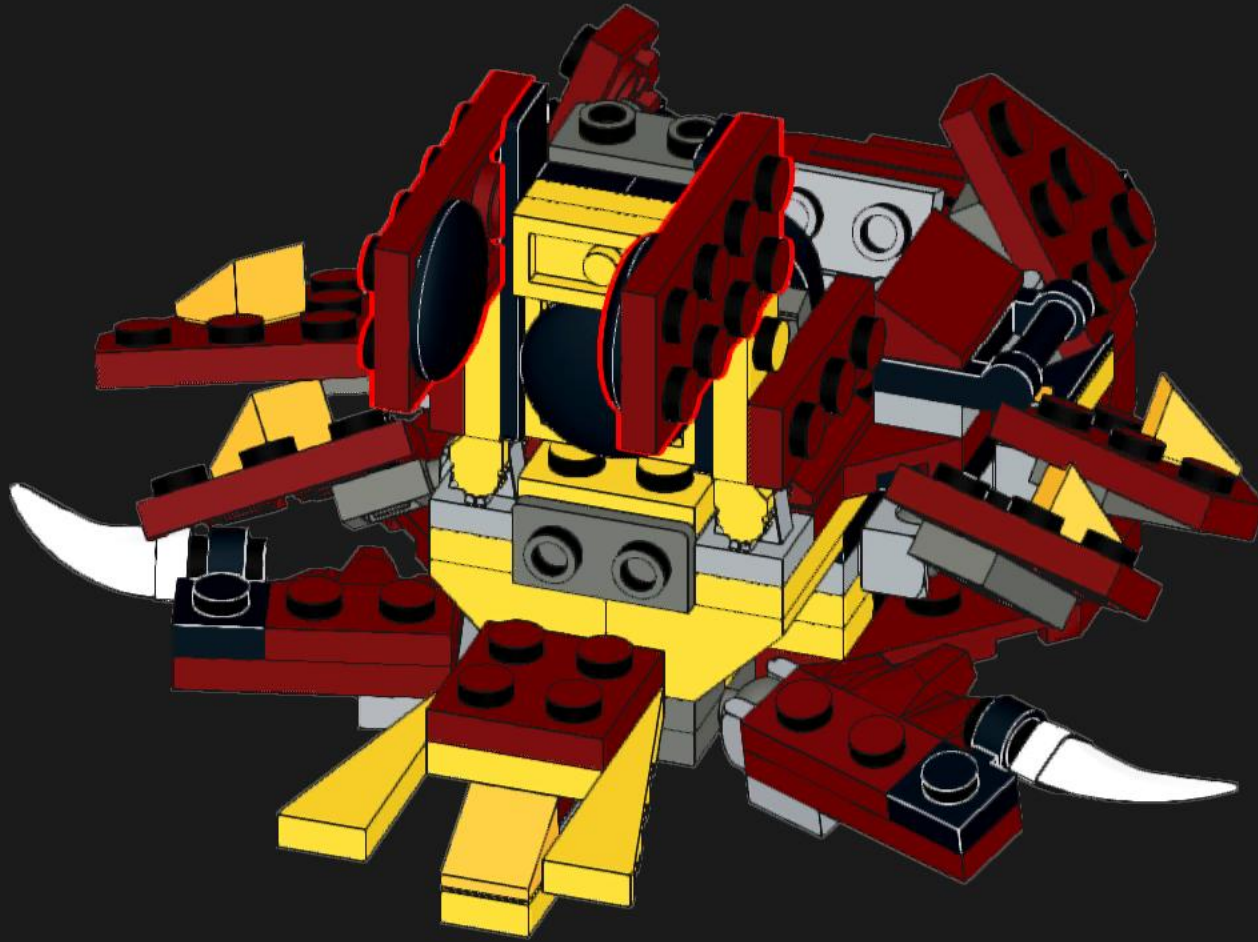
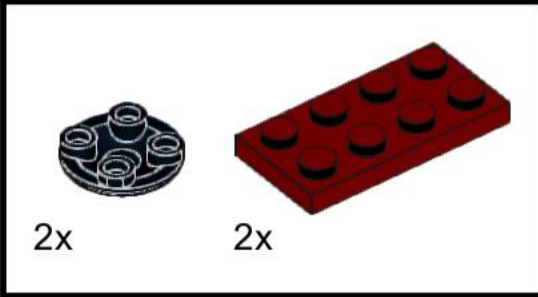



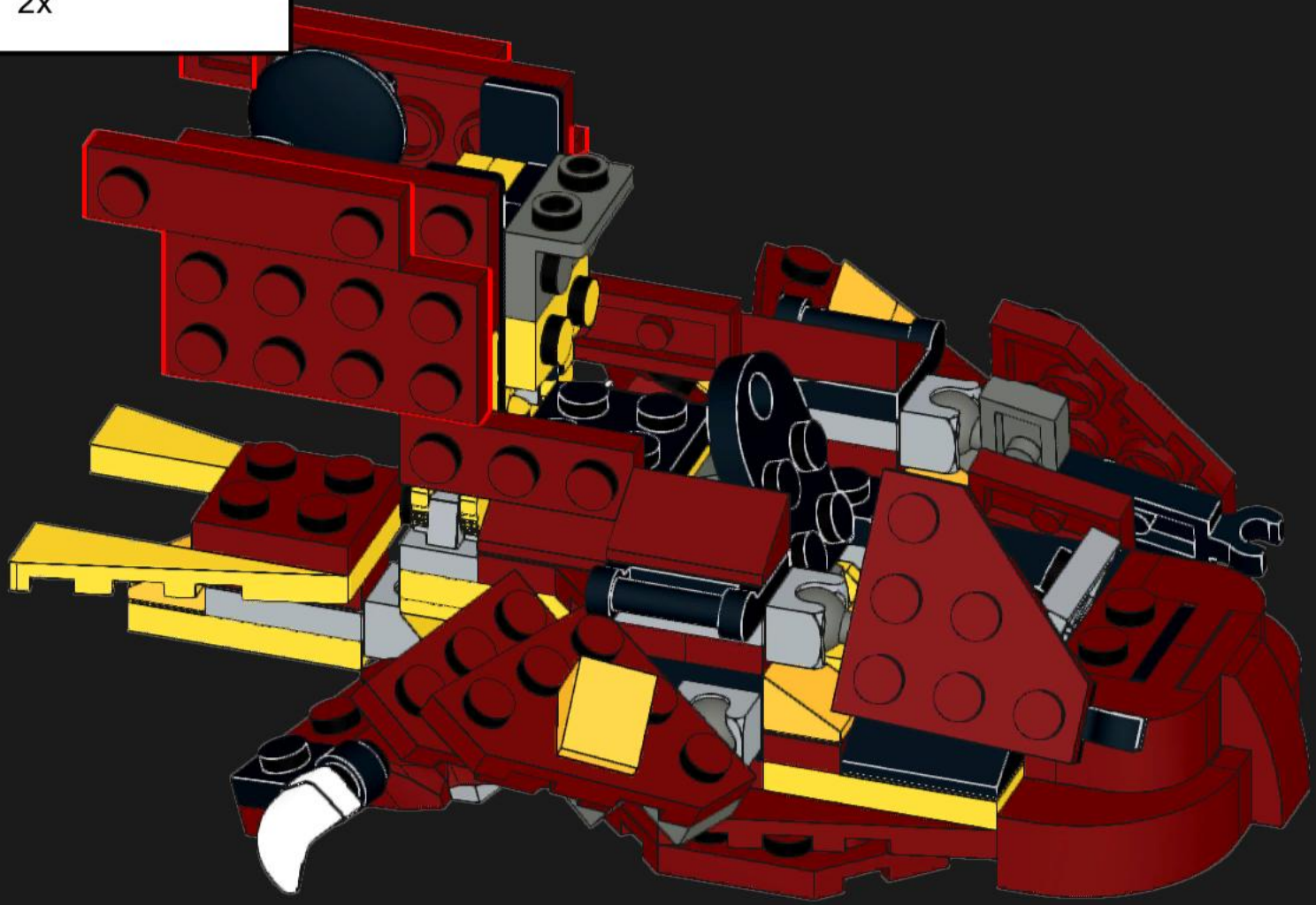
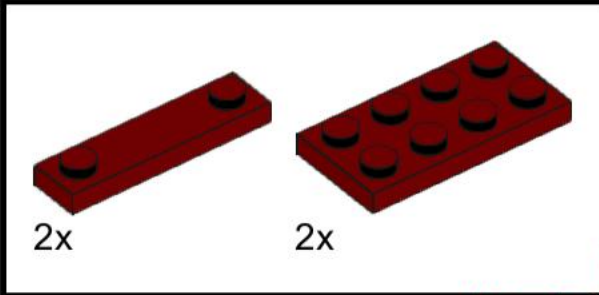

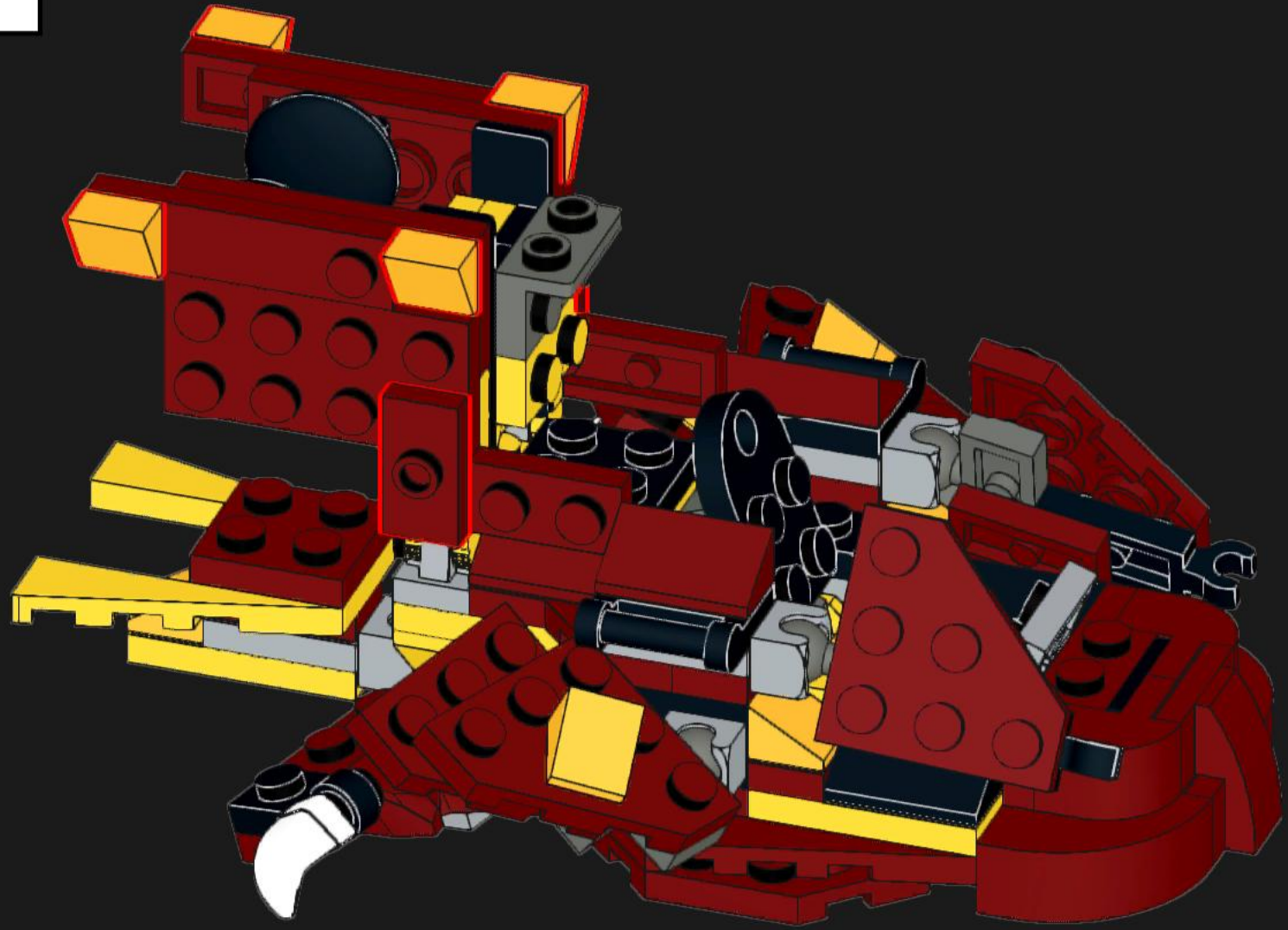
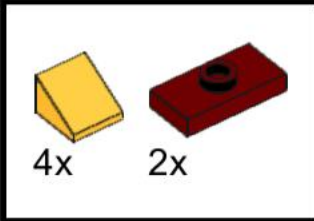

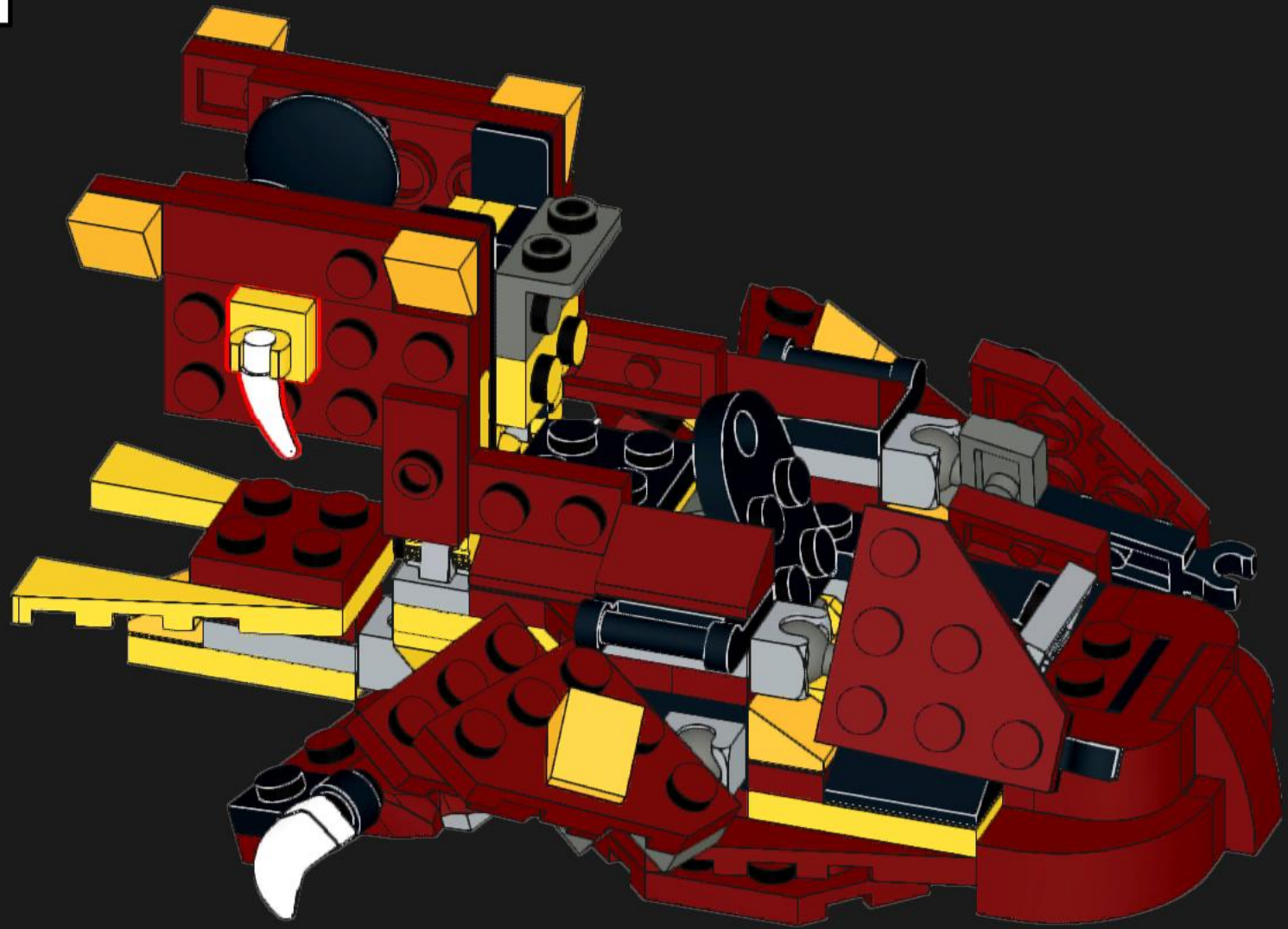
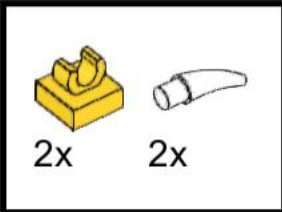



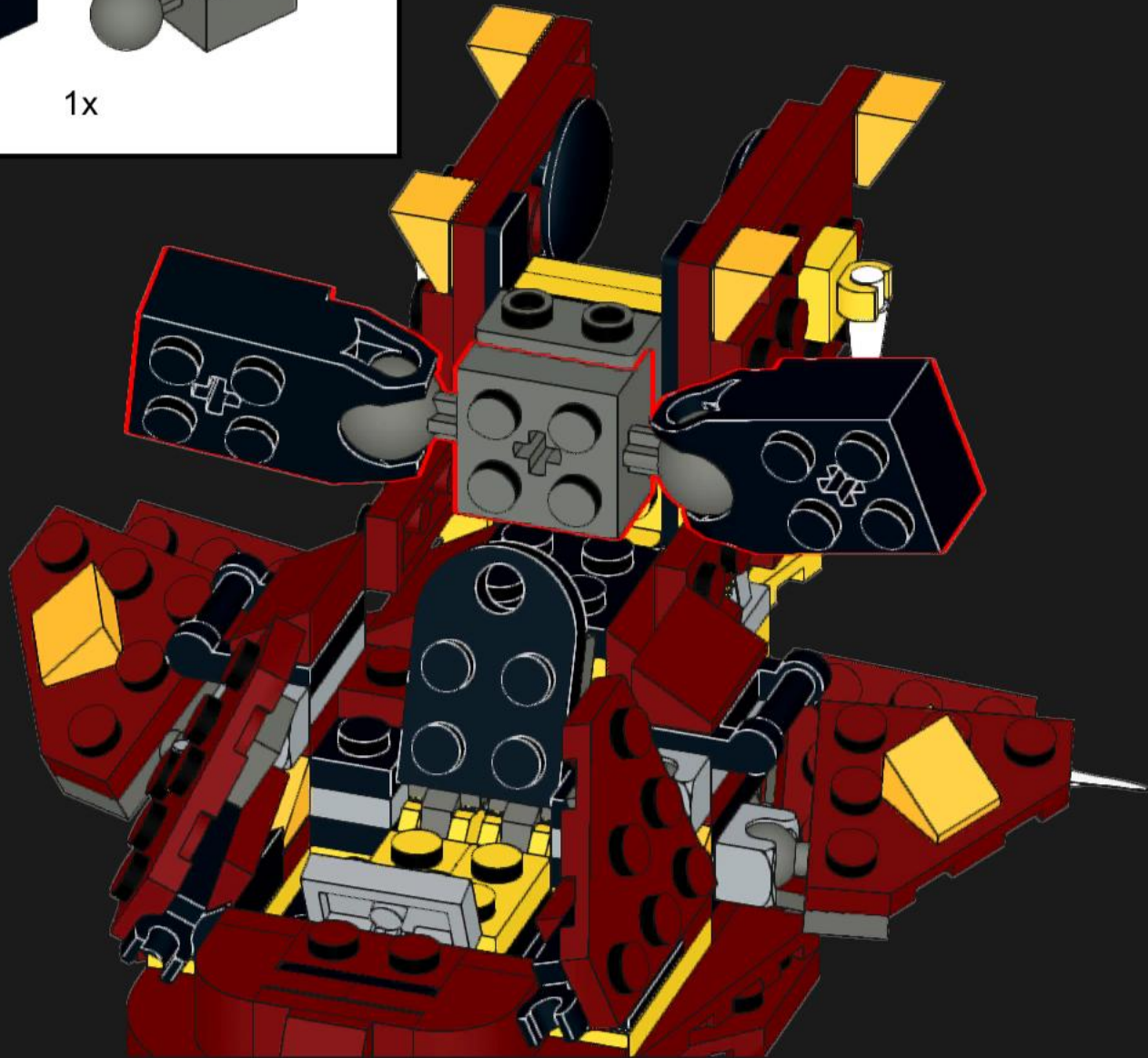
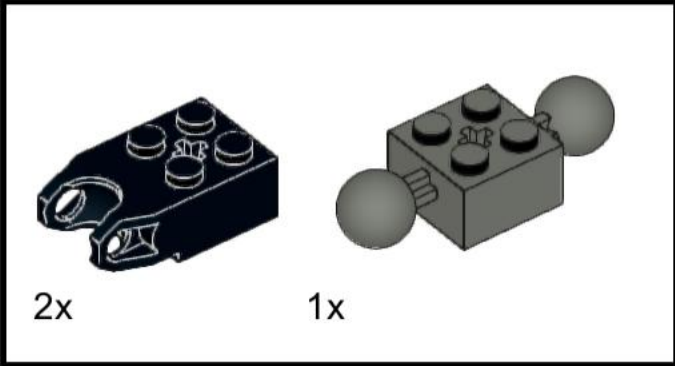

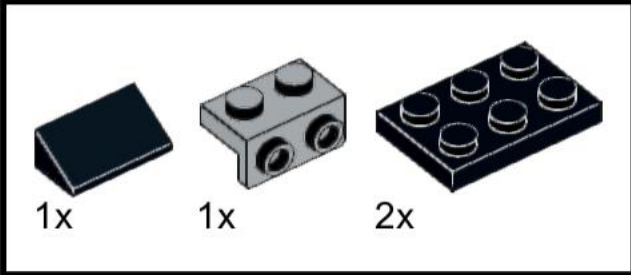

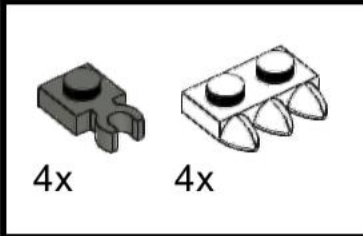



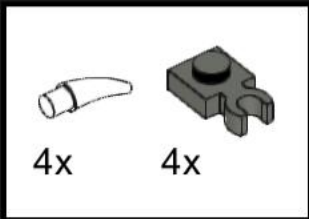

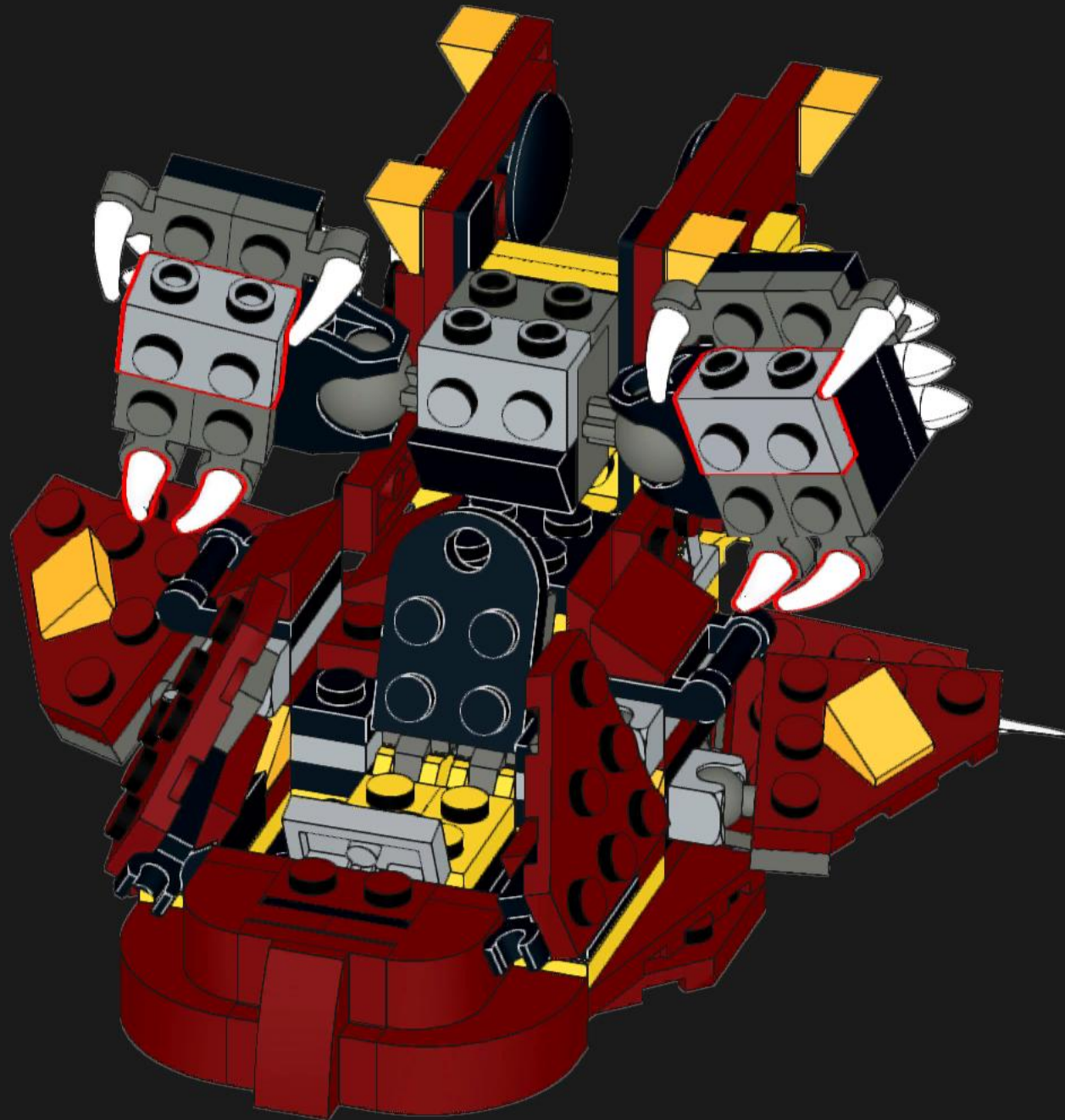
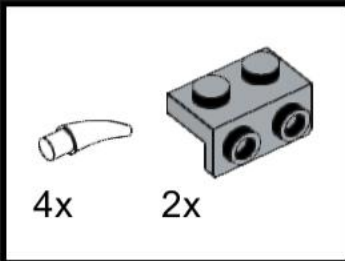

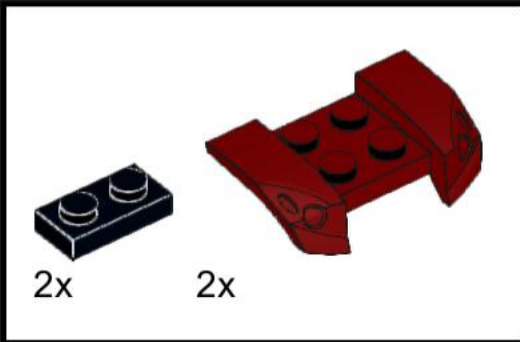





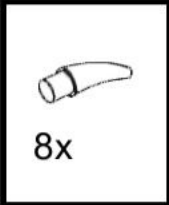

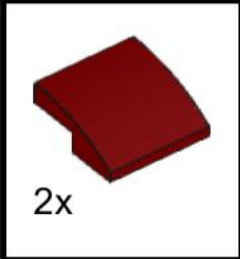



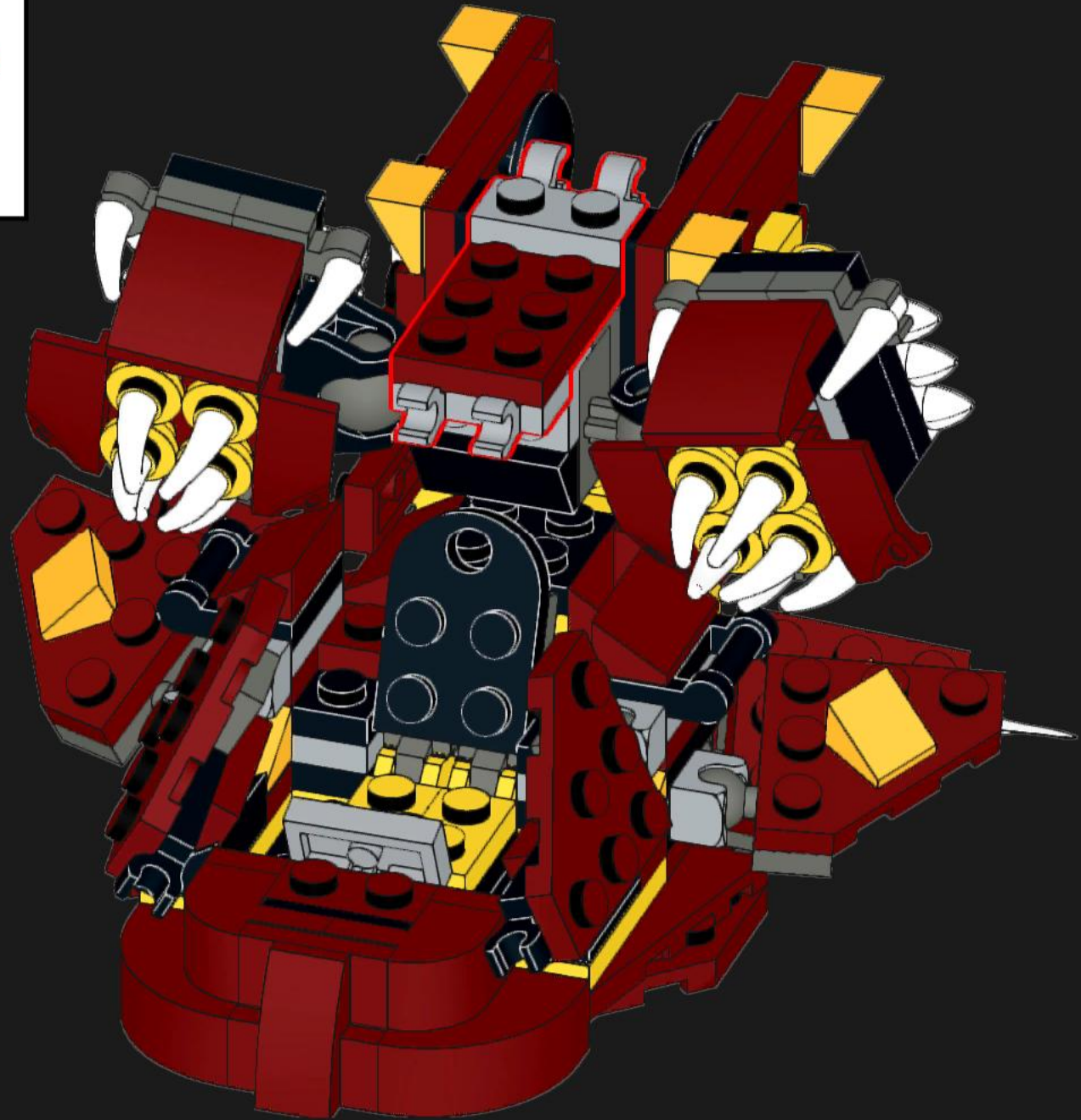
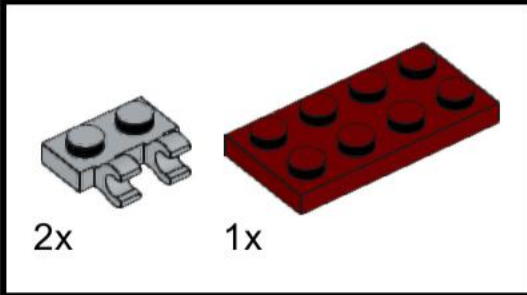

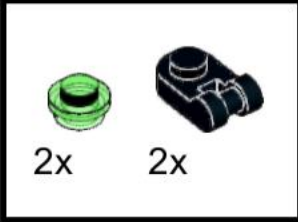



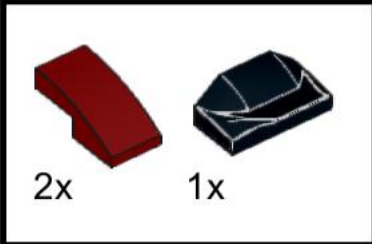





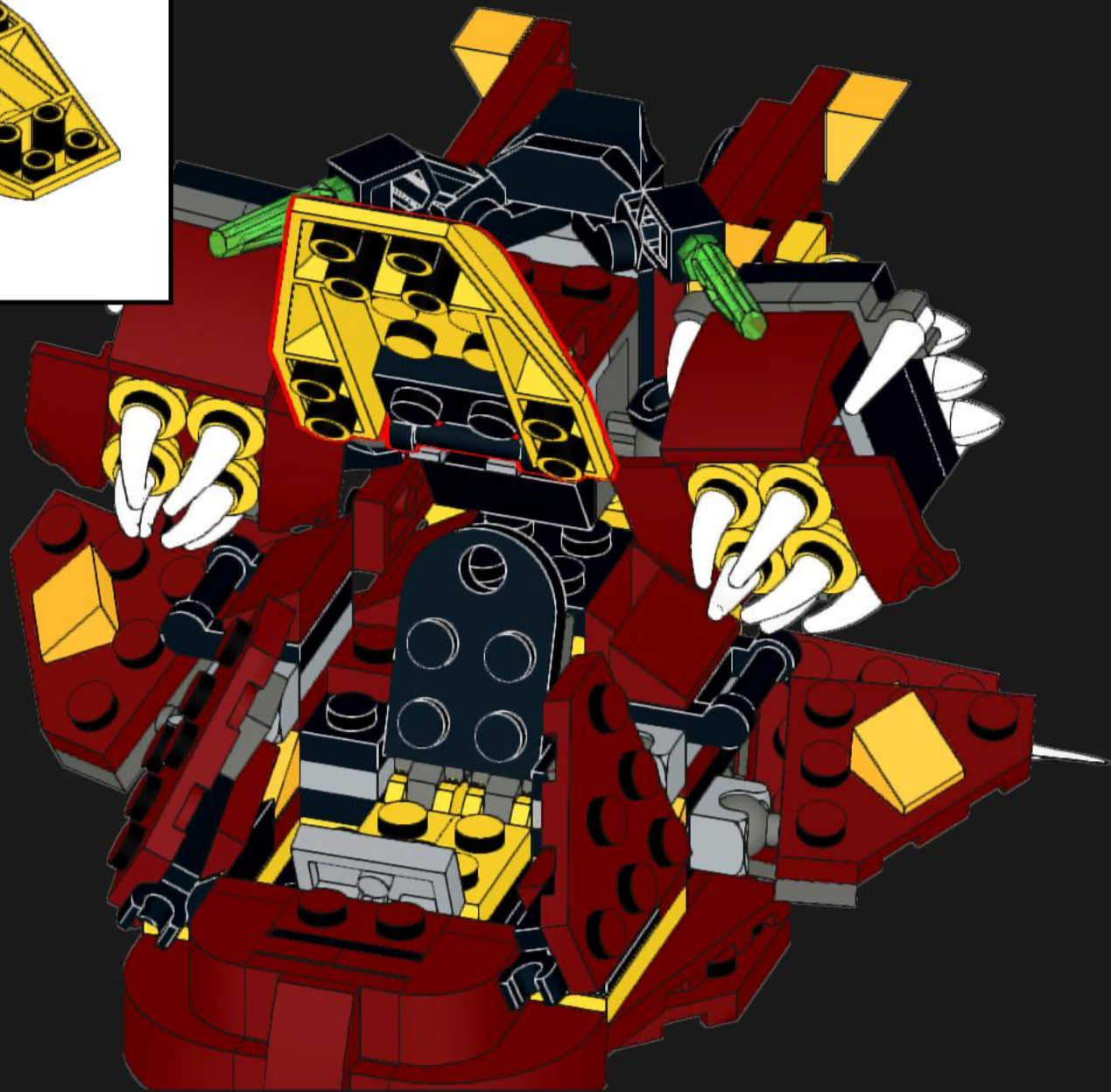
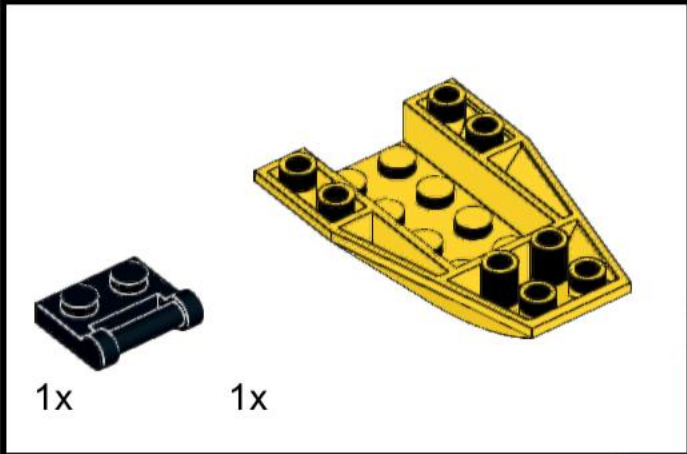

48

