

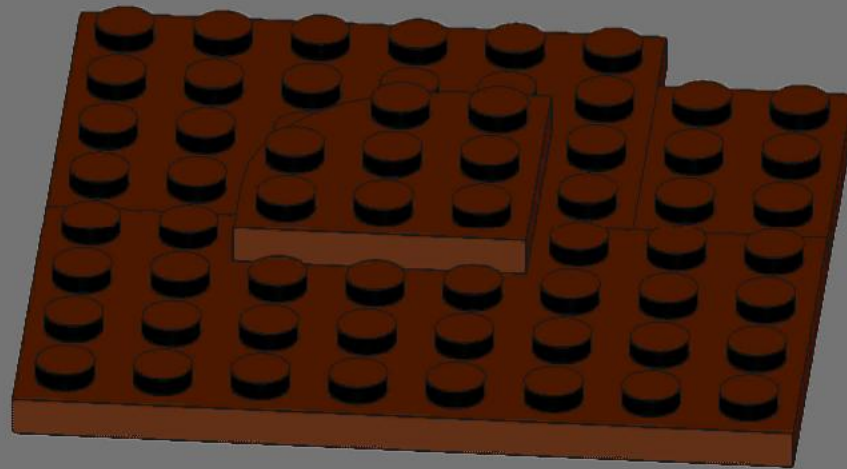

1

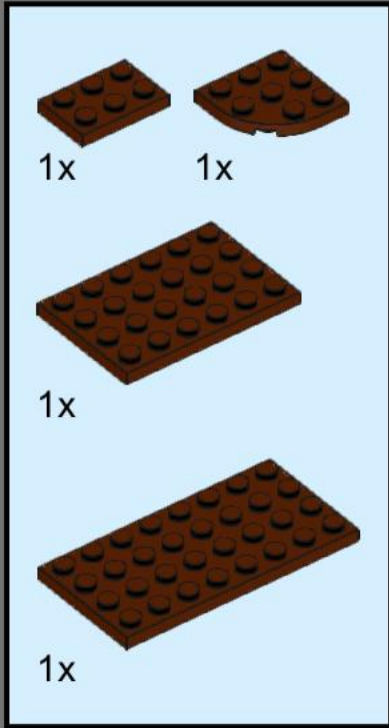

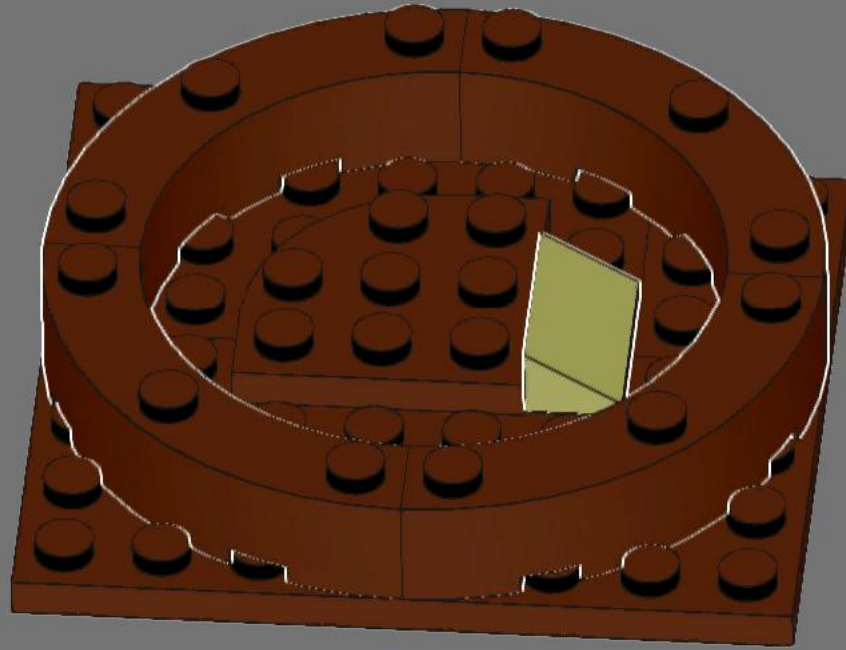

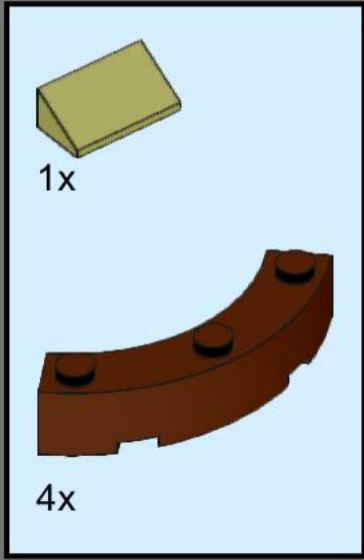

2

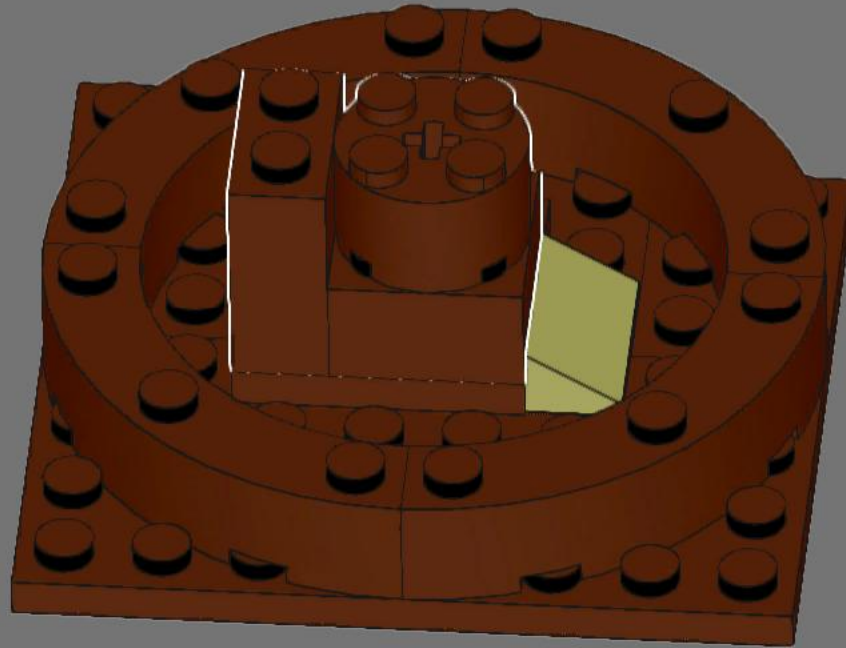
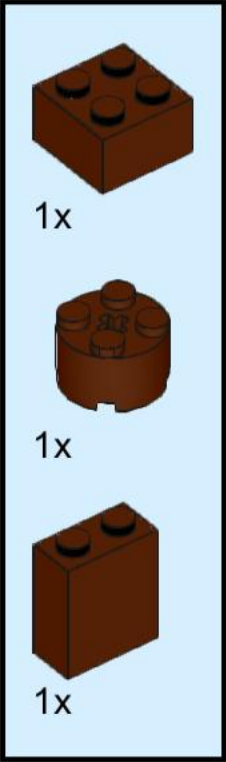

3





- 
1x
- 
1x
- 
1x
- 
1x

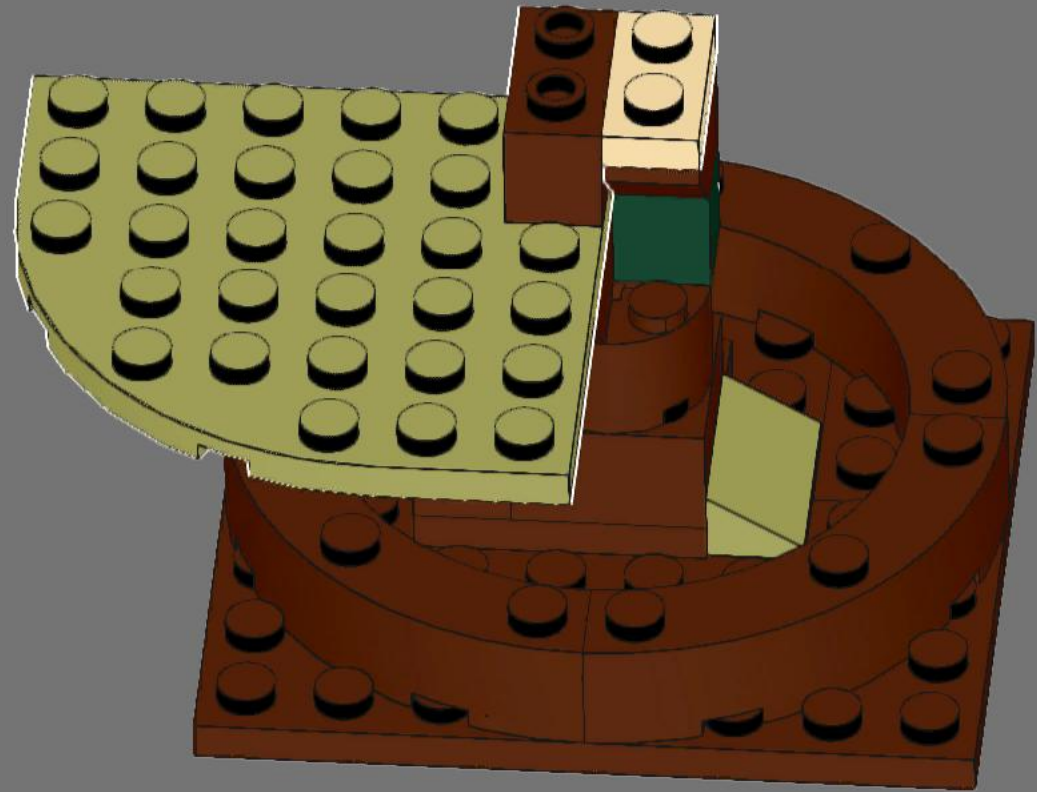
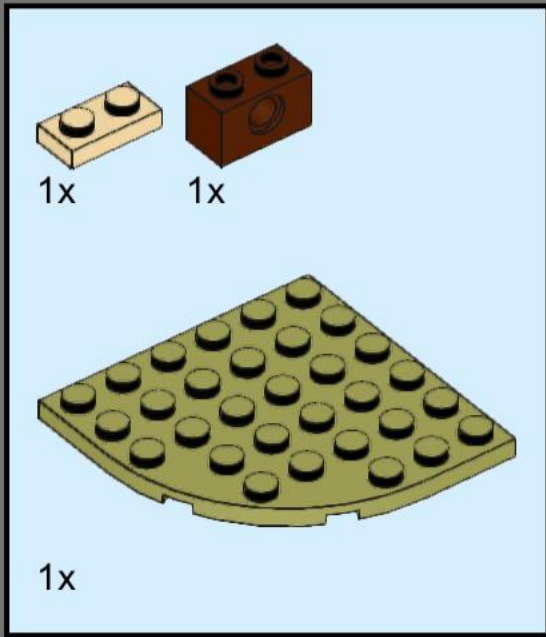

5

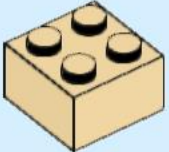

- 
1x
- 
2x
- 
1x
- 
1x

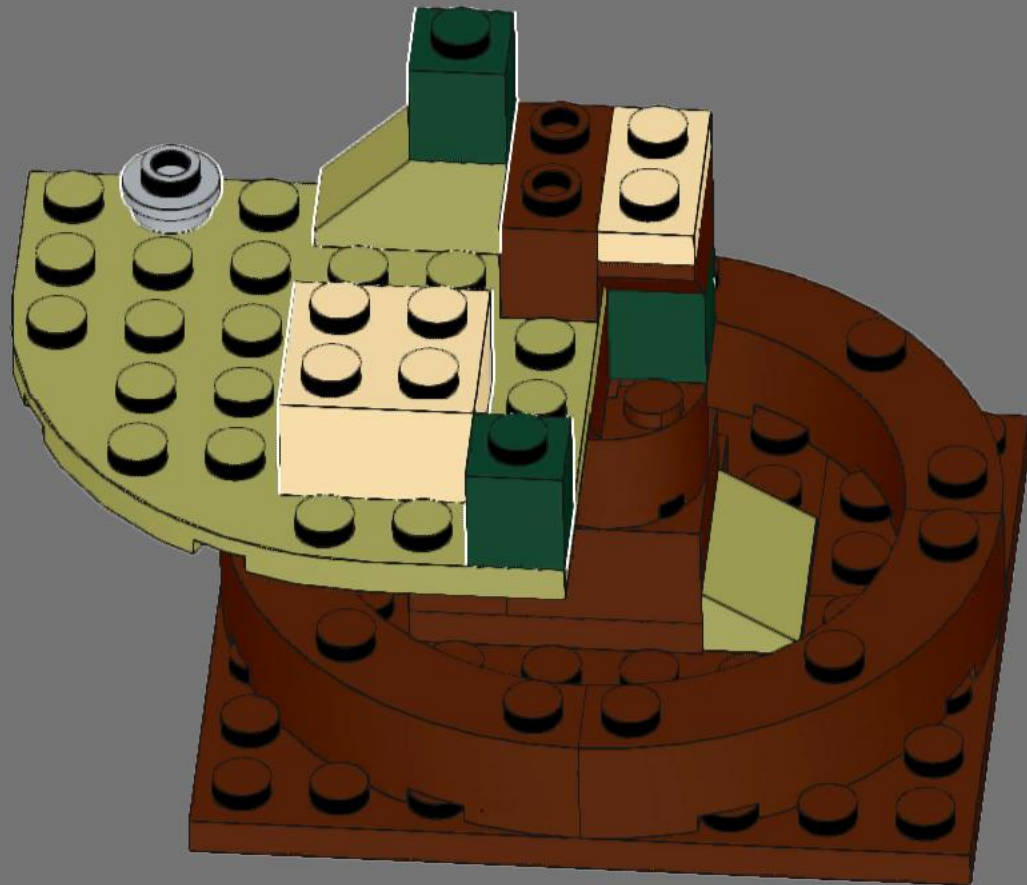

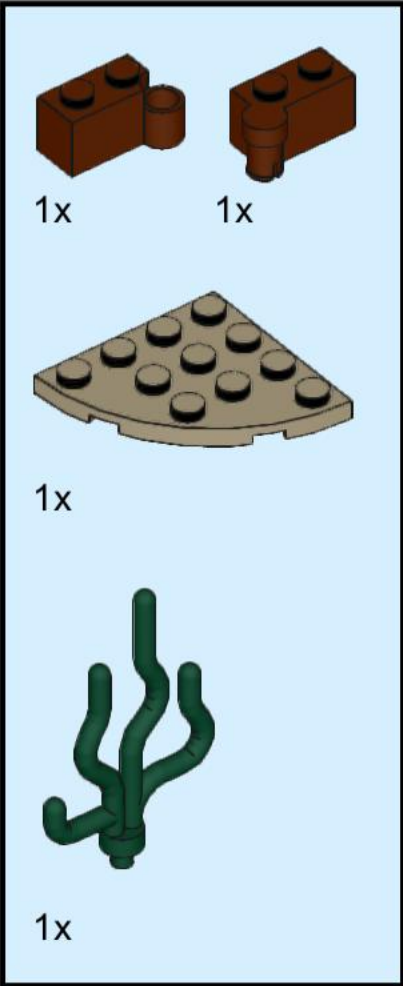

1x

1x

1x

1x

This panel lists the parts for step 7. It includes two brown 1x2 Technic bricks with a small cylindrical protrusion on the right side, each labeled '1x'. It also includes a tan 1/4 circle Technic plate with 10 studs, labeled '1x'. Finally, it shows a green 1x2 Technic coral piece with three branches, labeled '1x'.



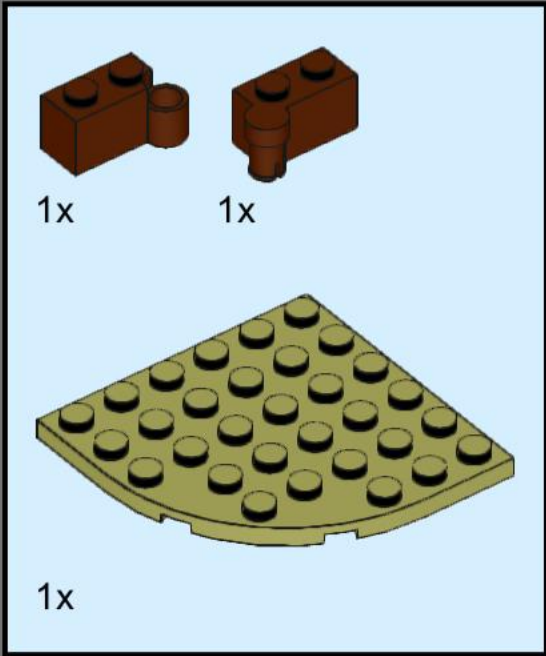

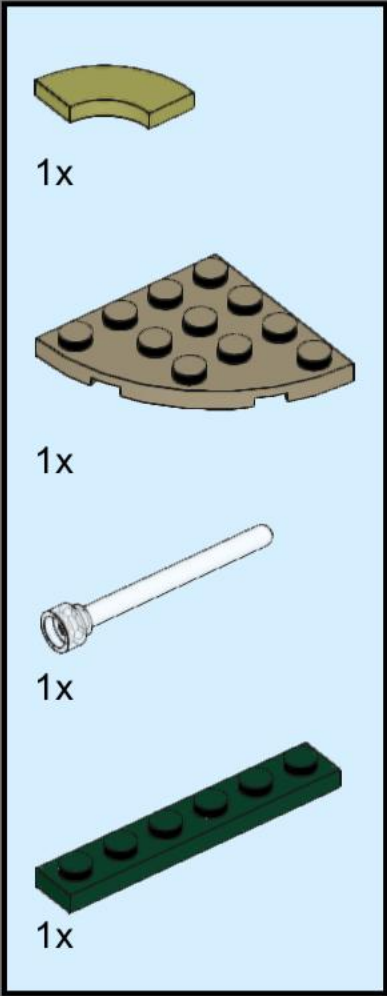

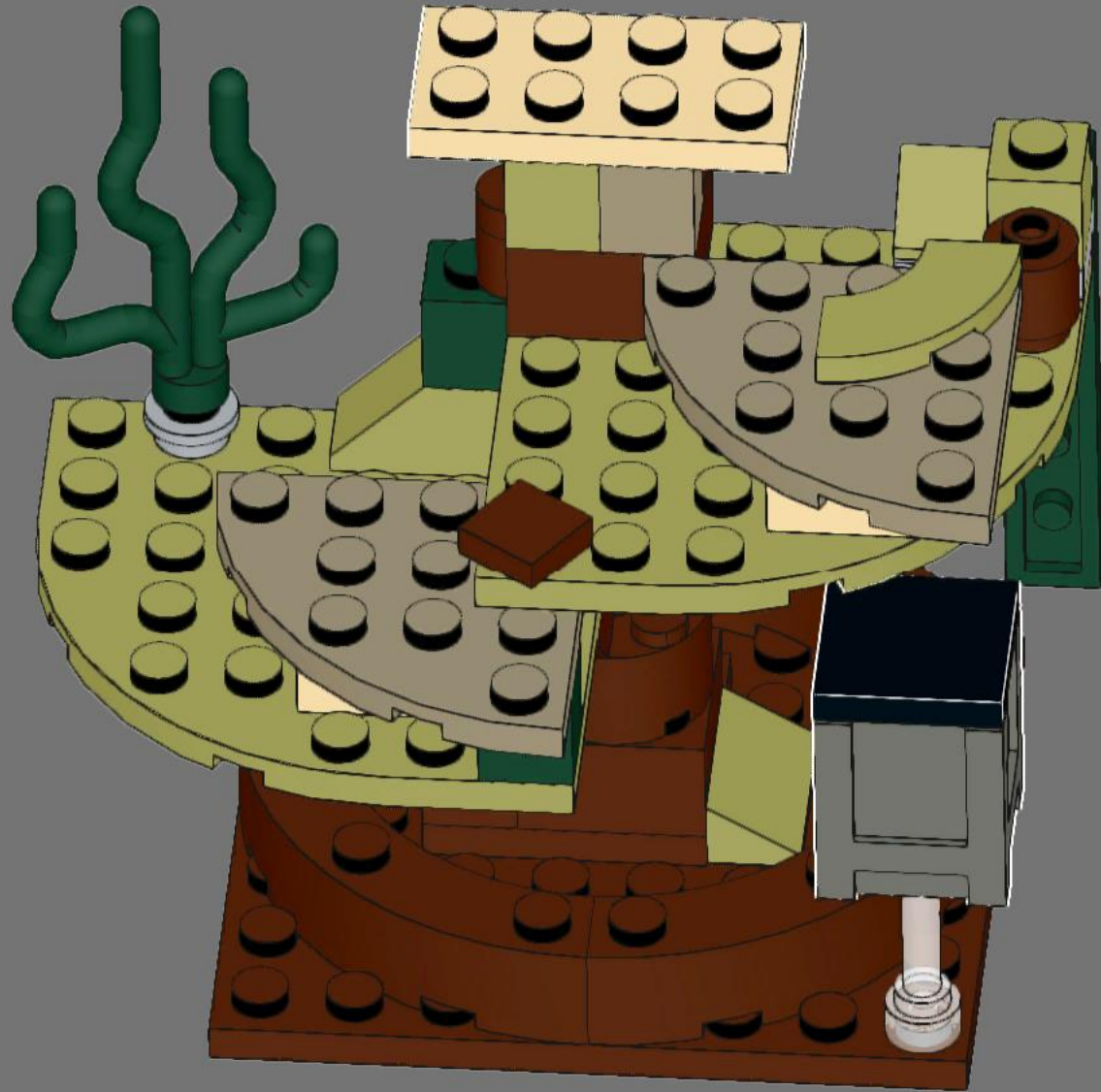
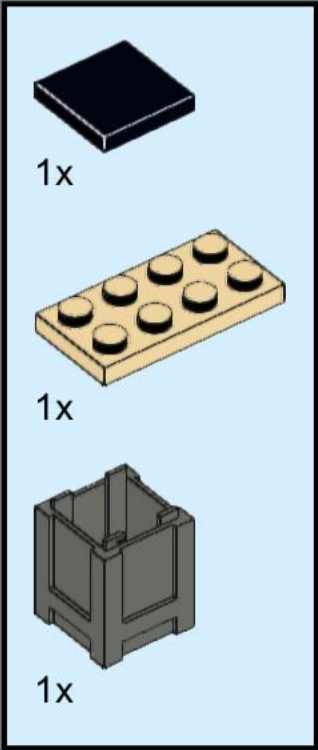

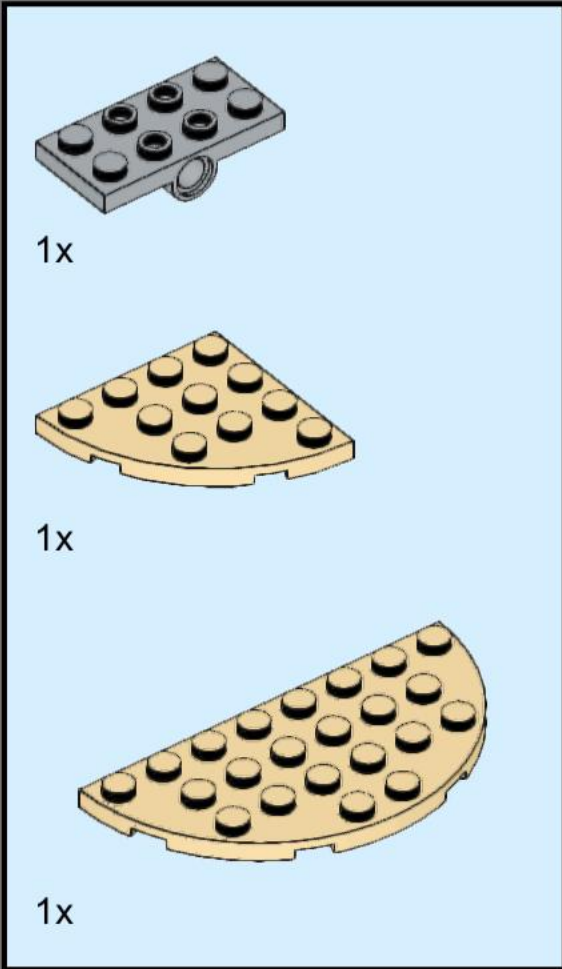

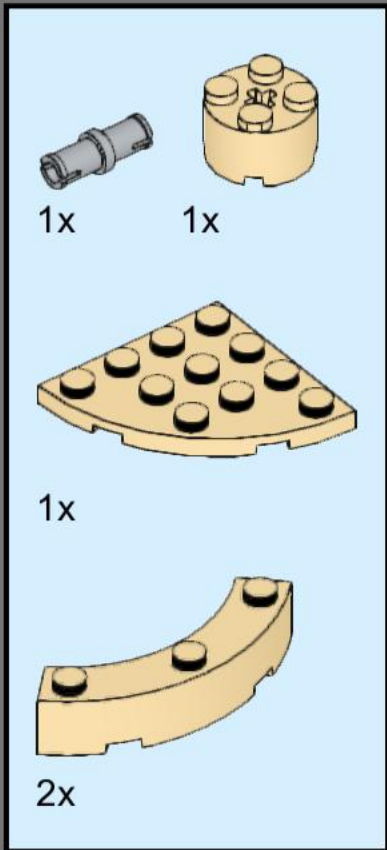

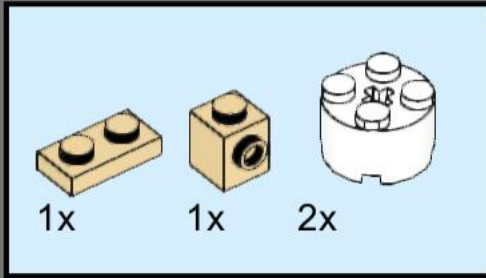

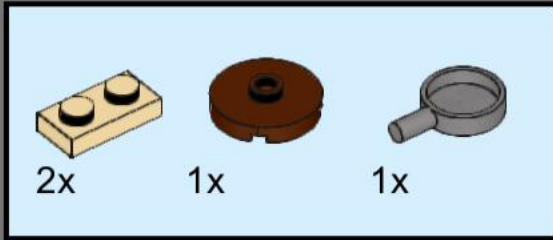





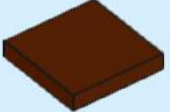



- 
1x
- 
1x
- 
1x
- 
1x
- 
1x
- 
1x

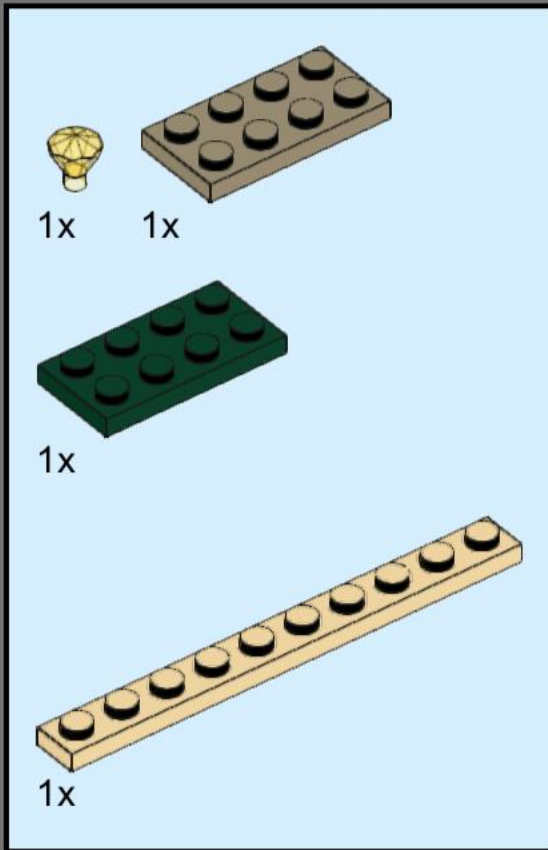



3x



1x



1x

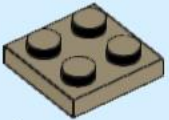

1x

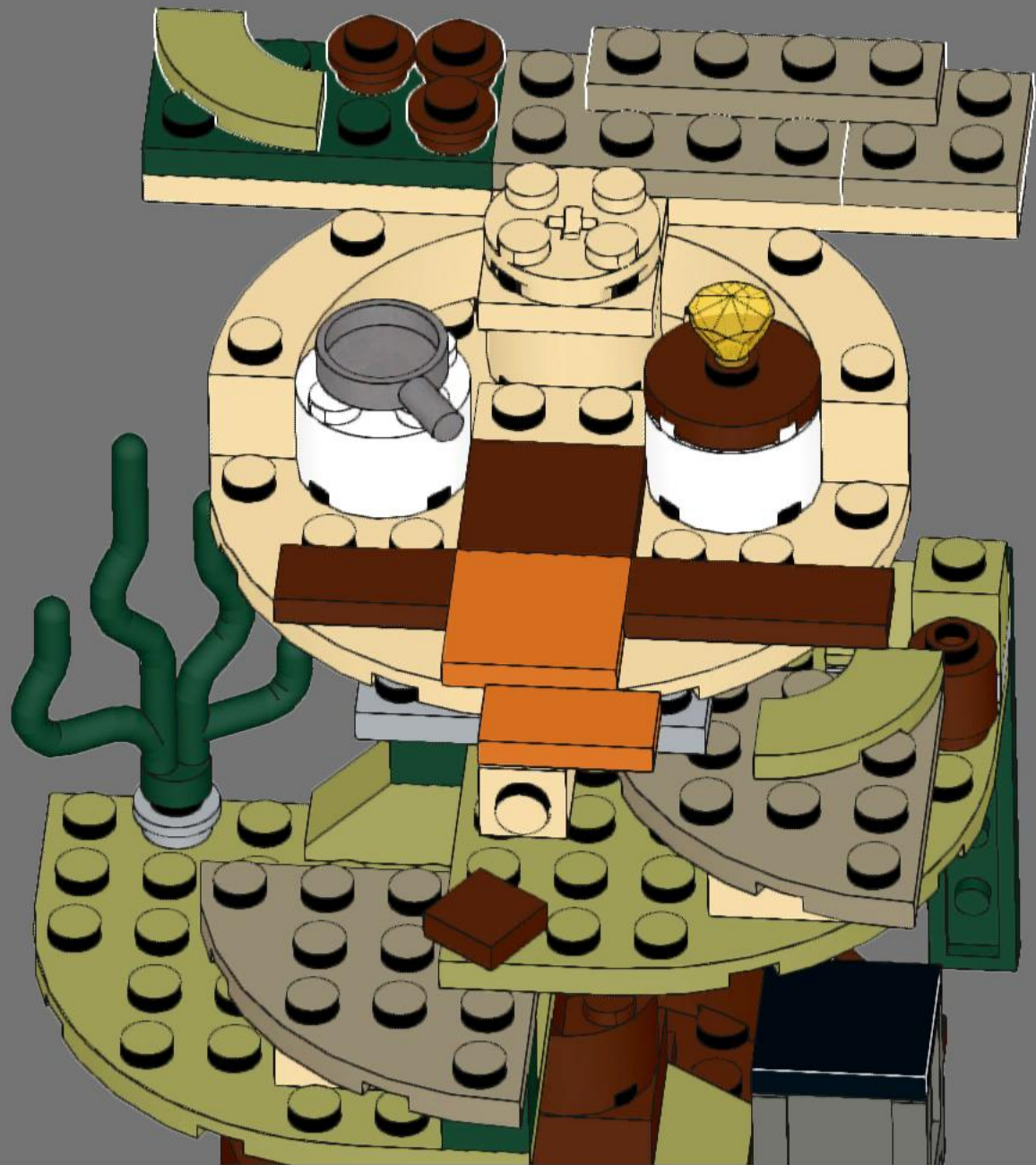
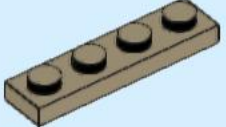

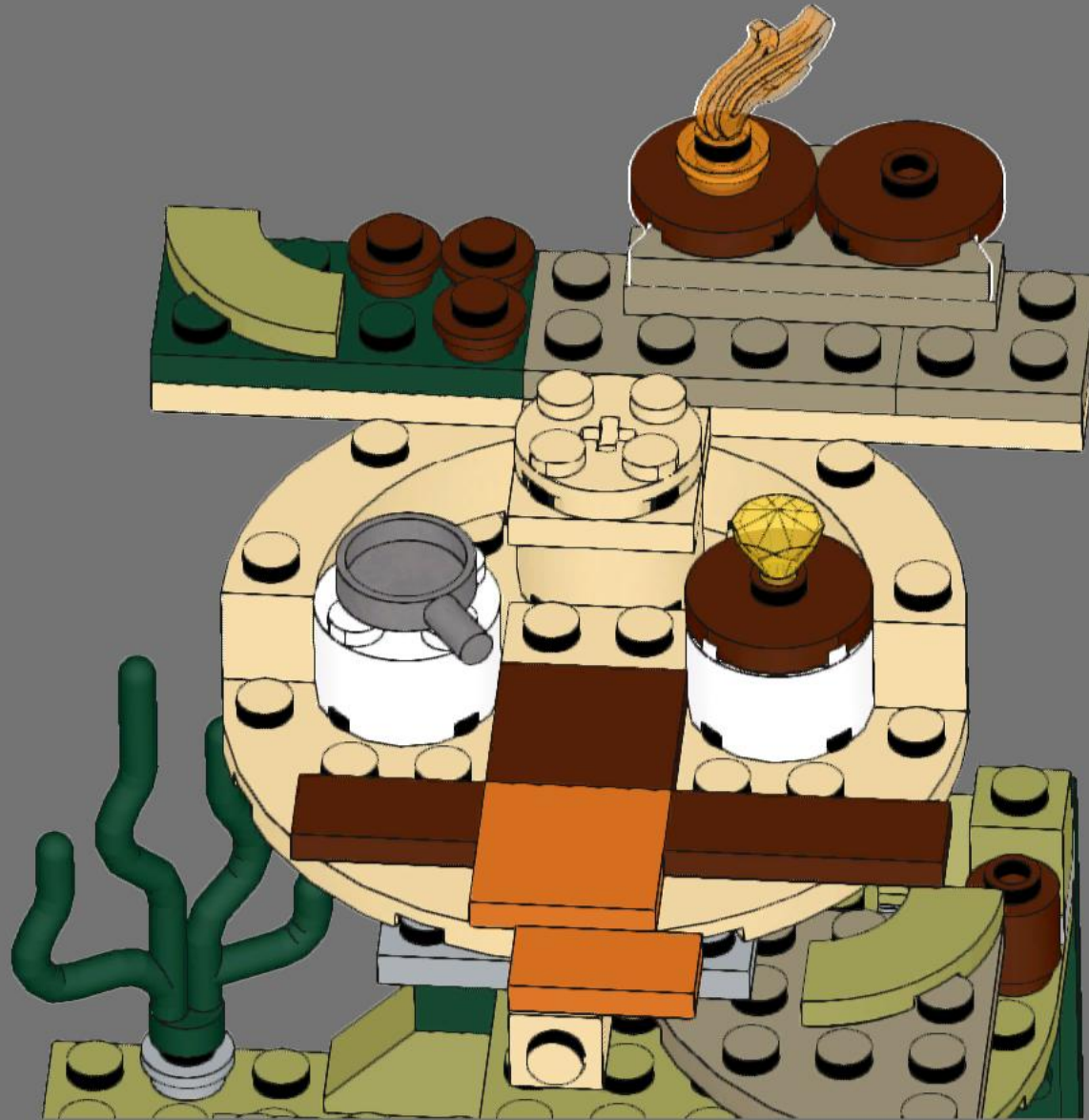
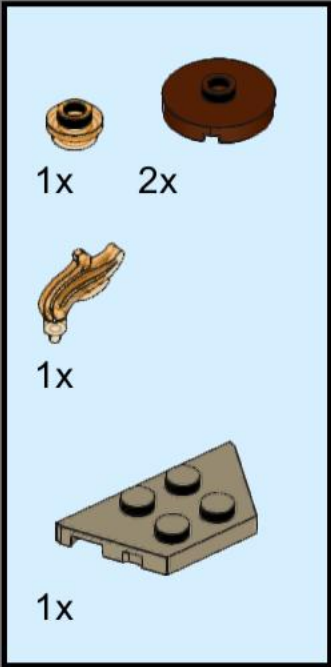

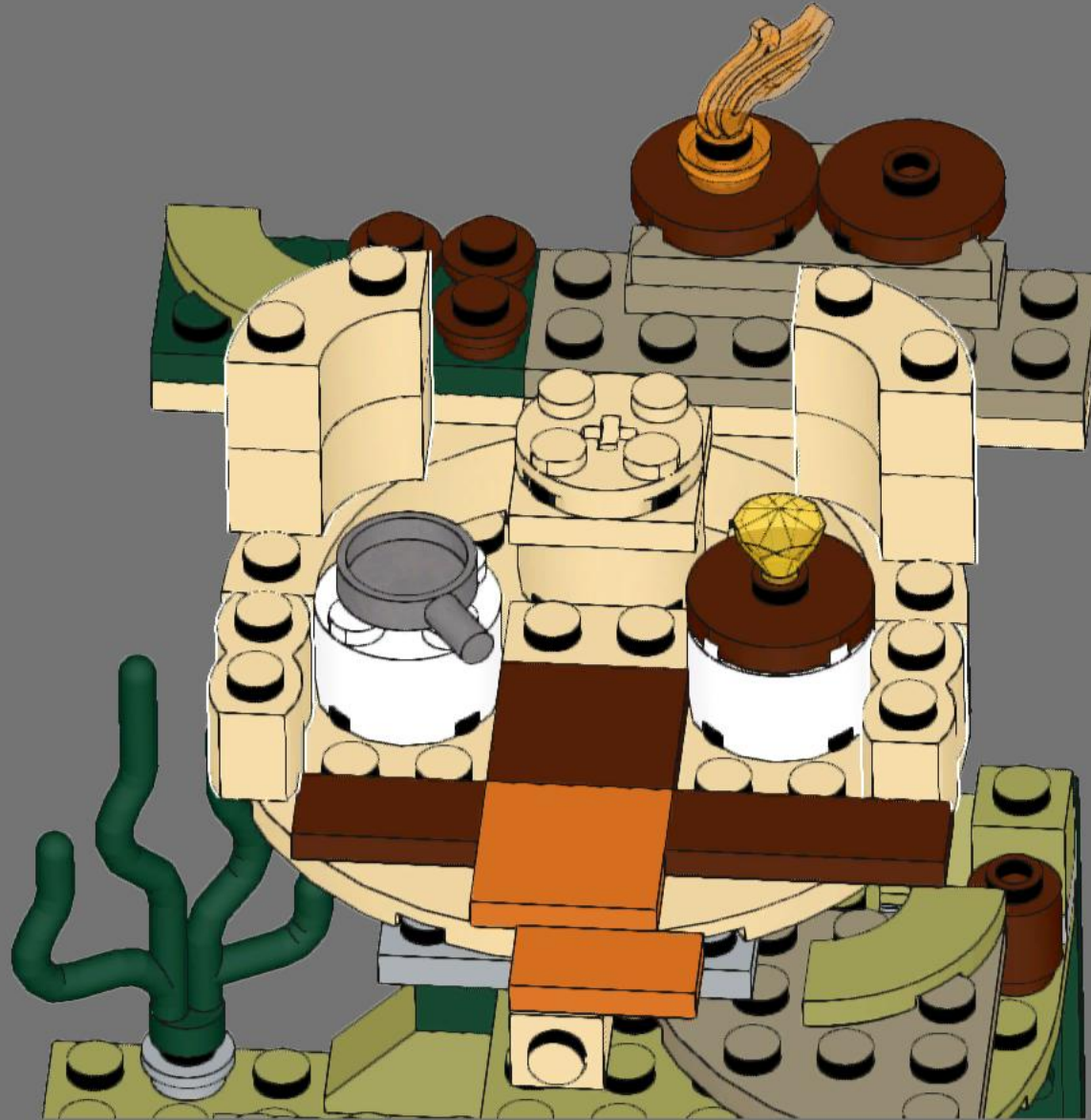
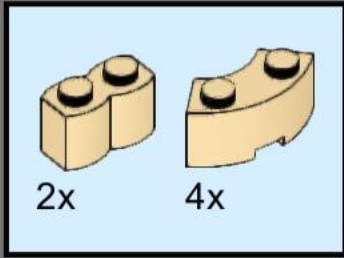

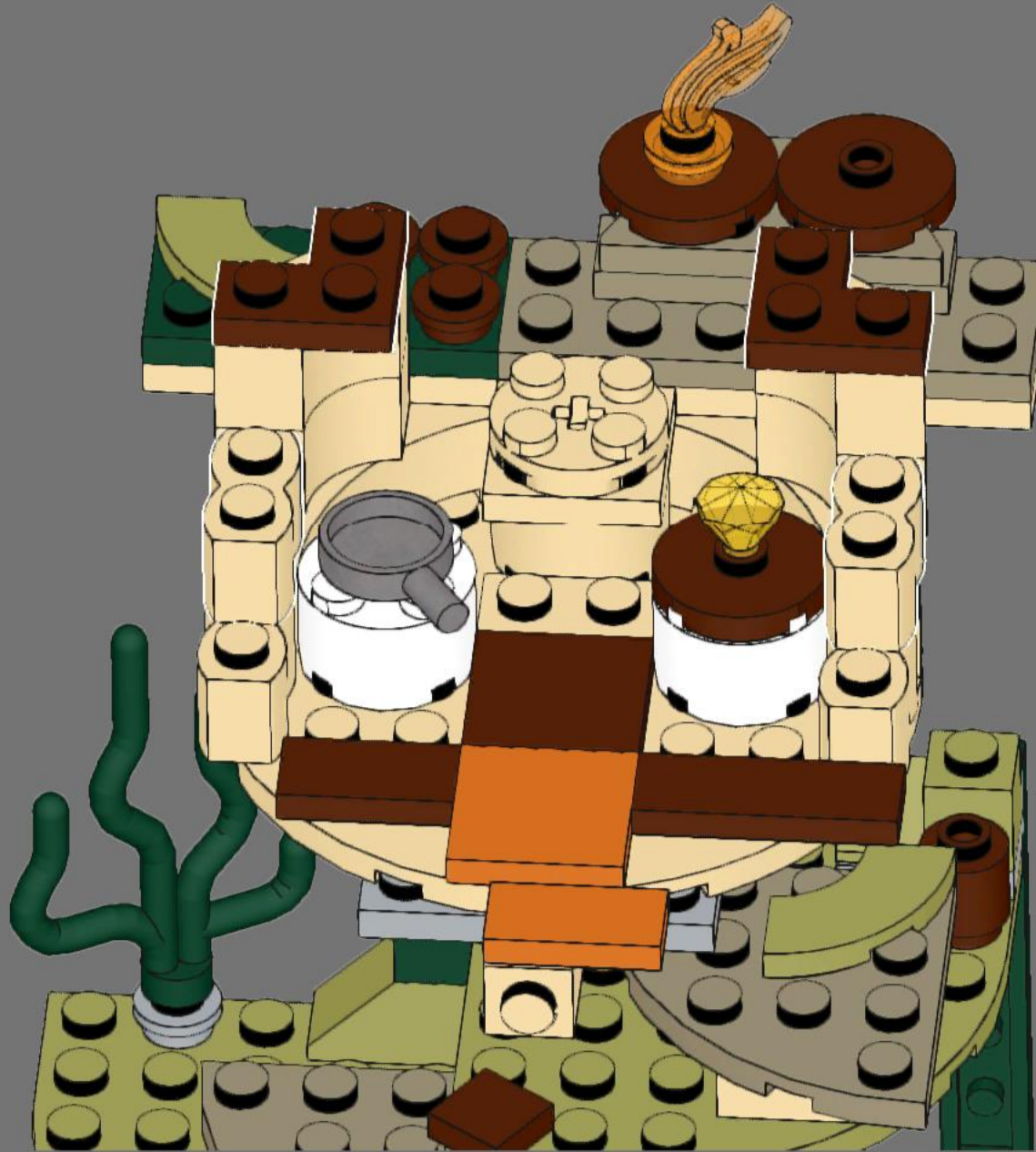
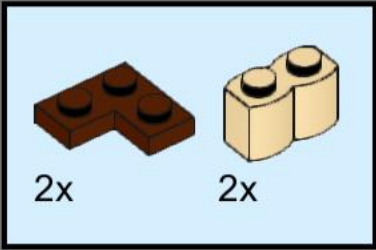

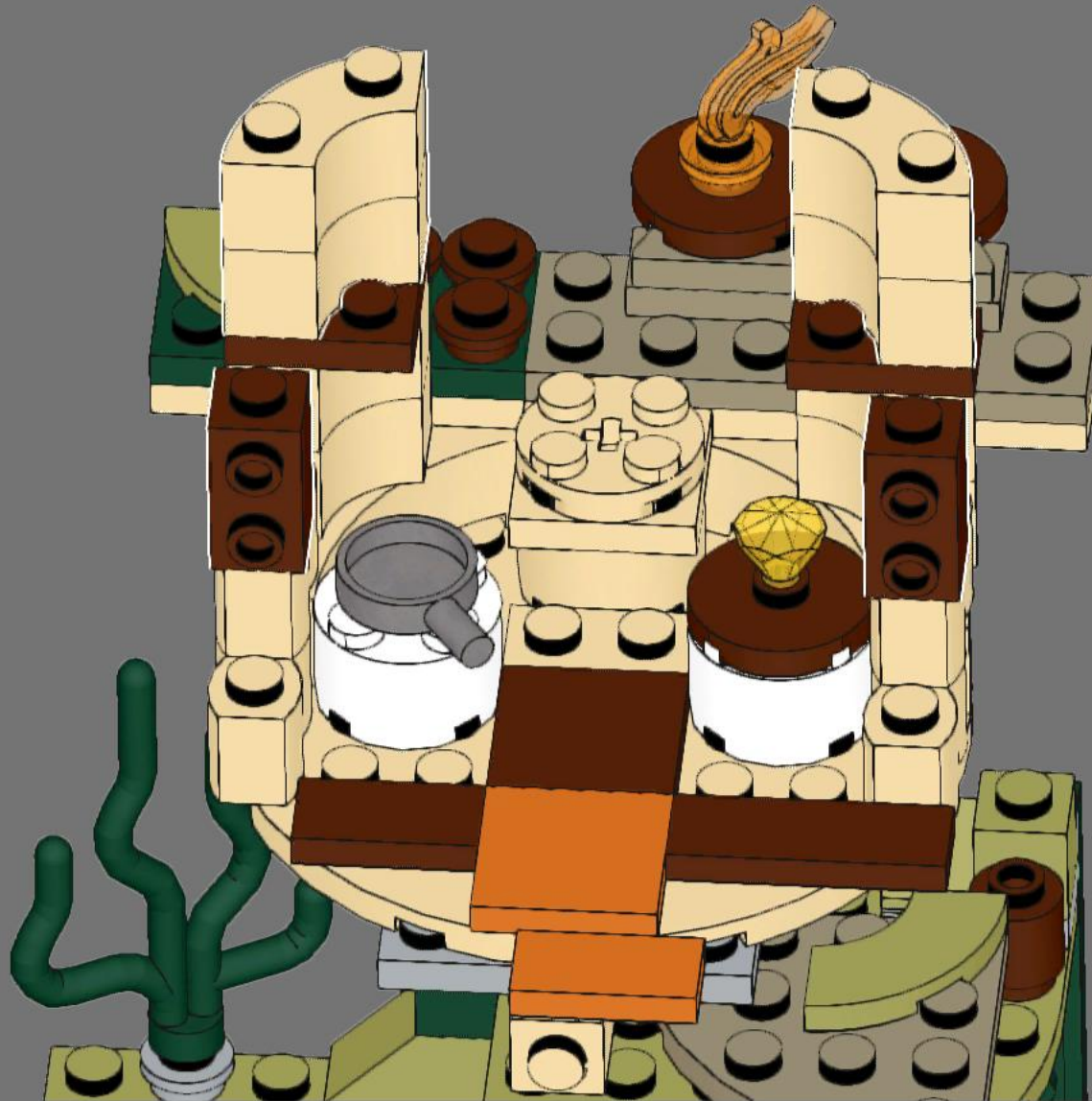
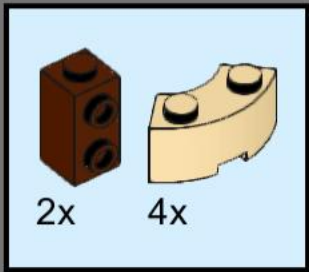

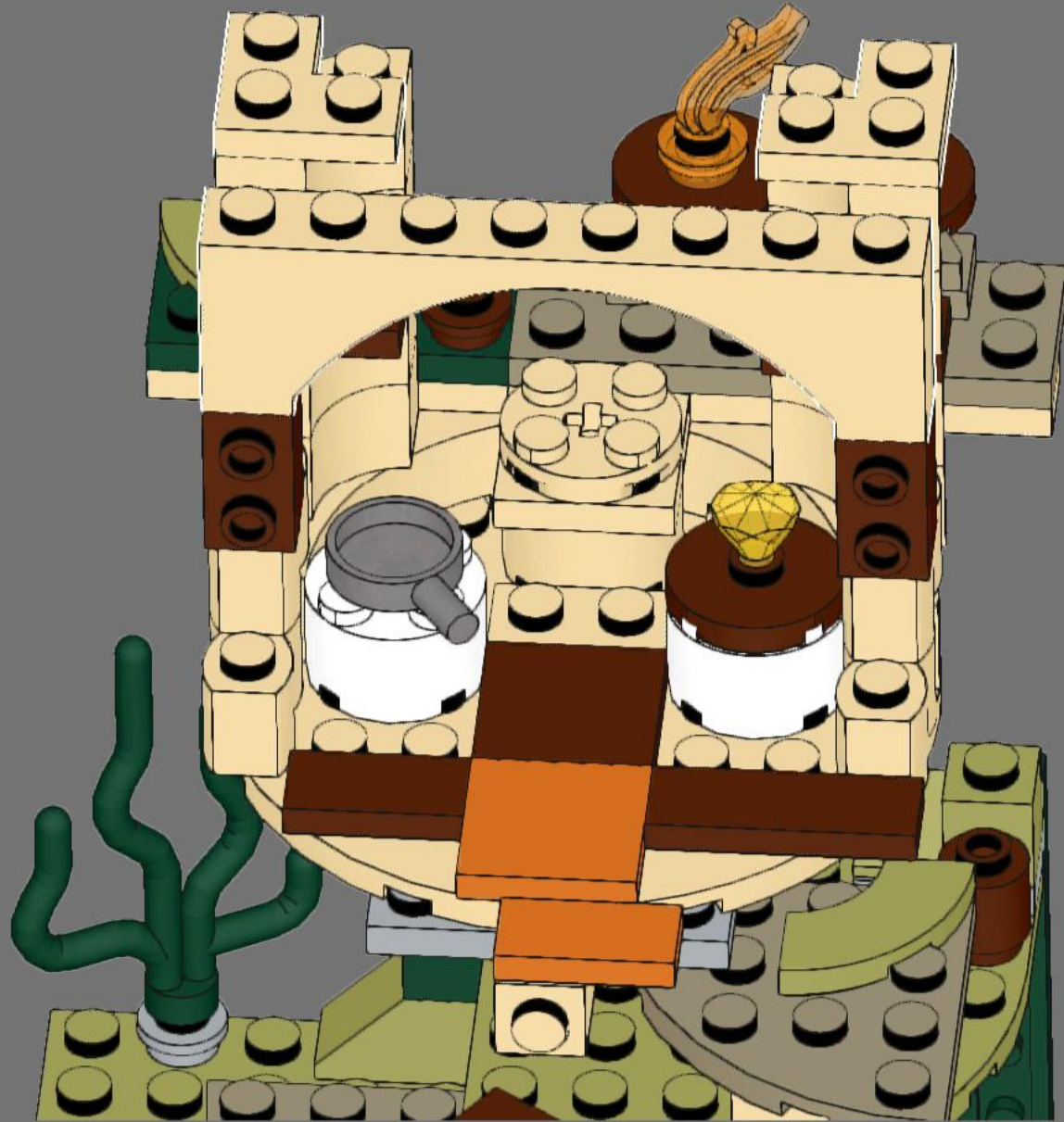
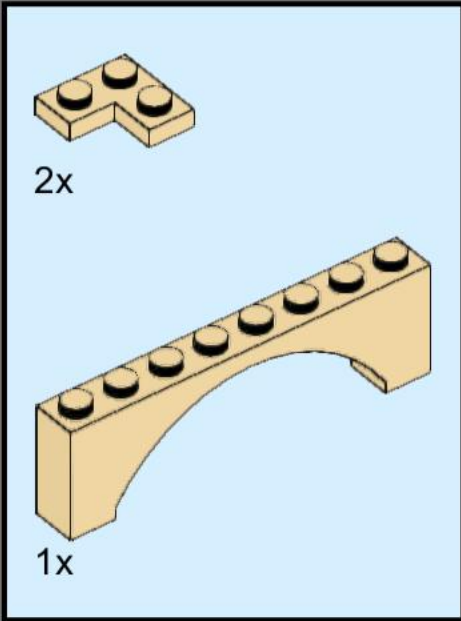

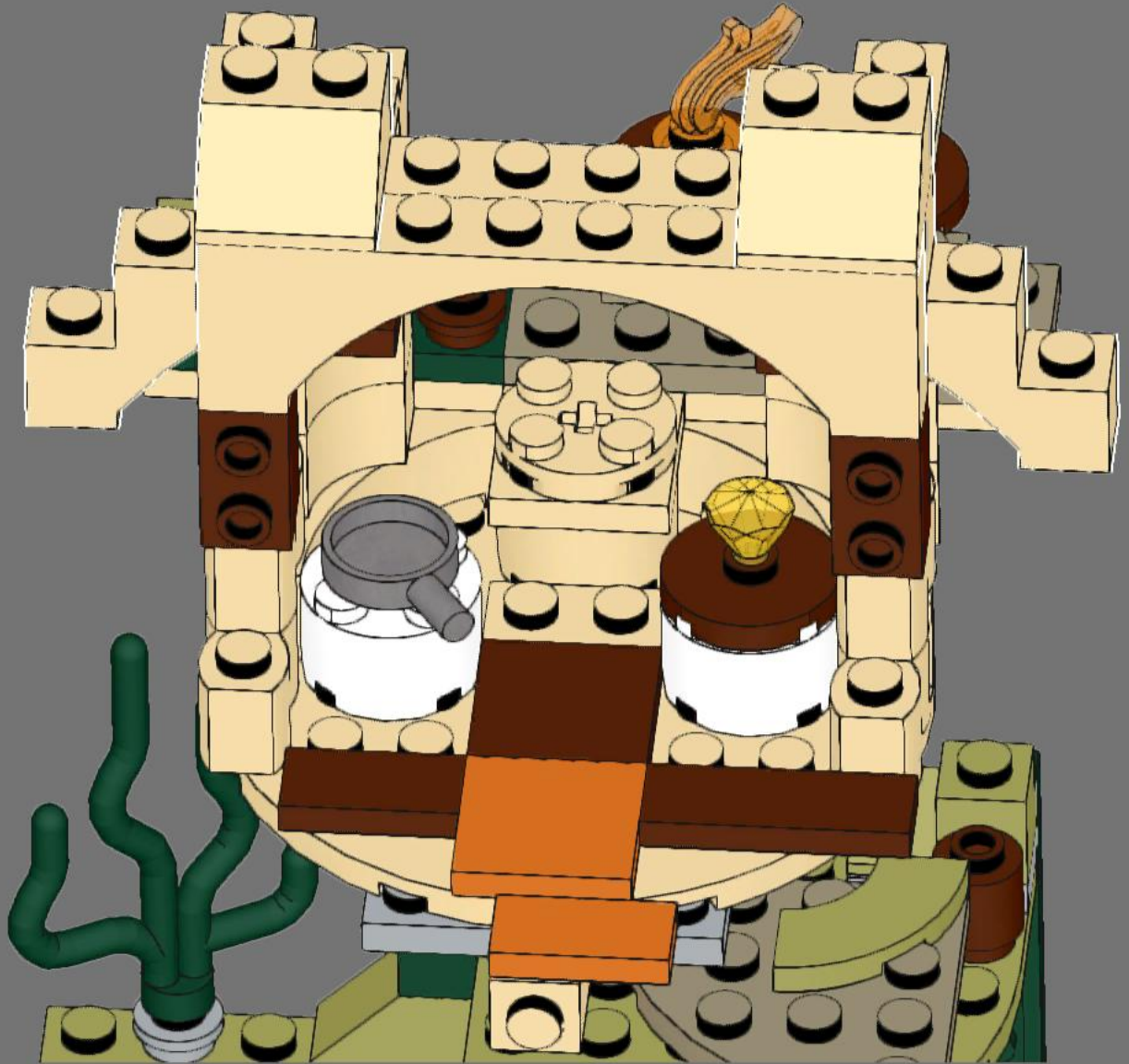
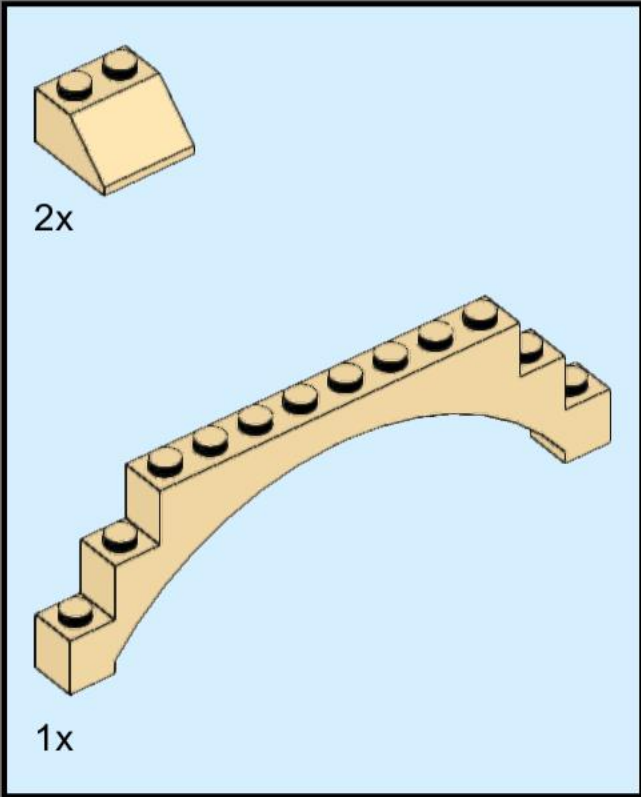

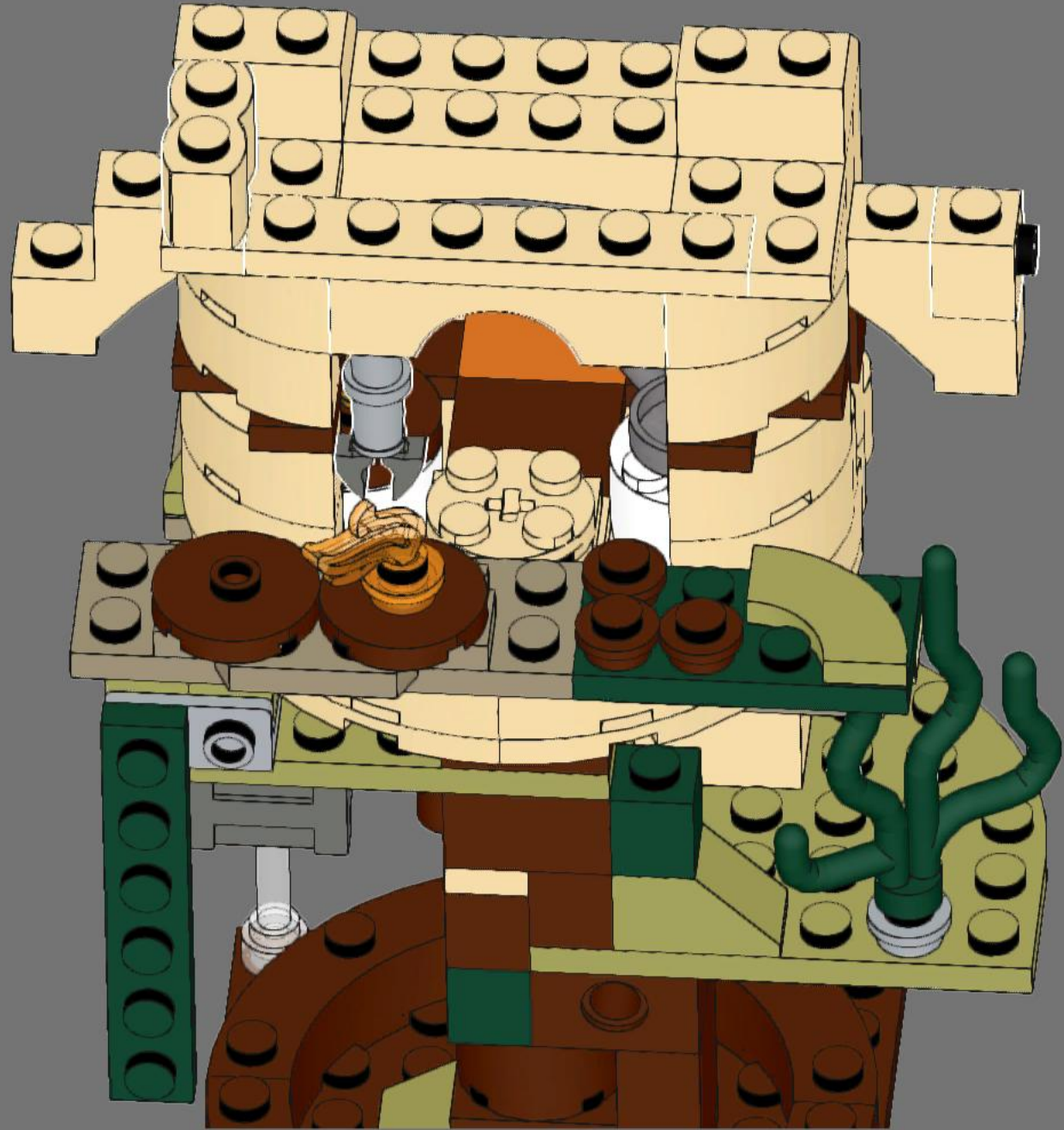
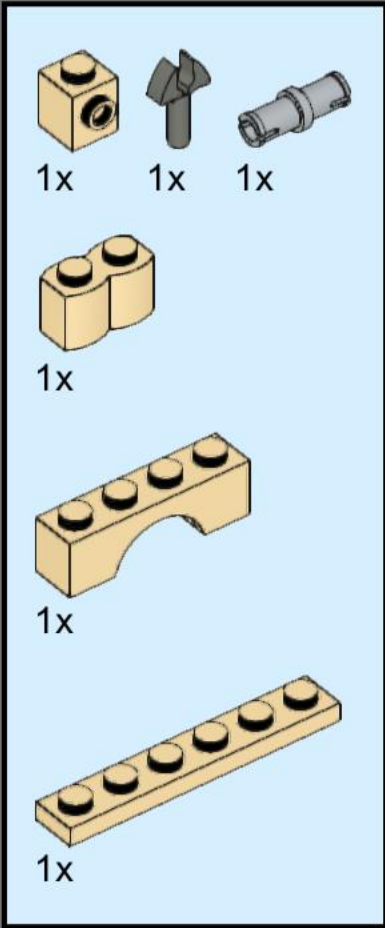

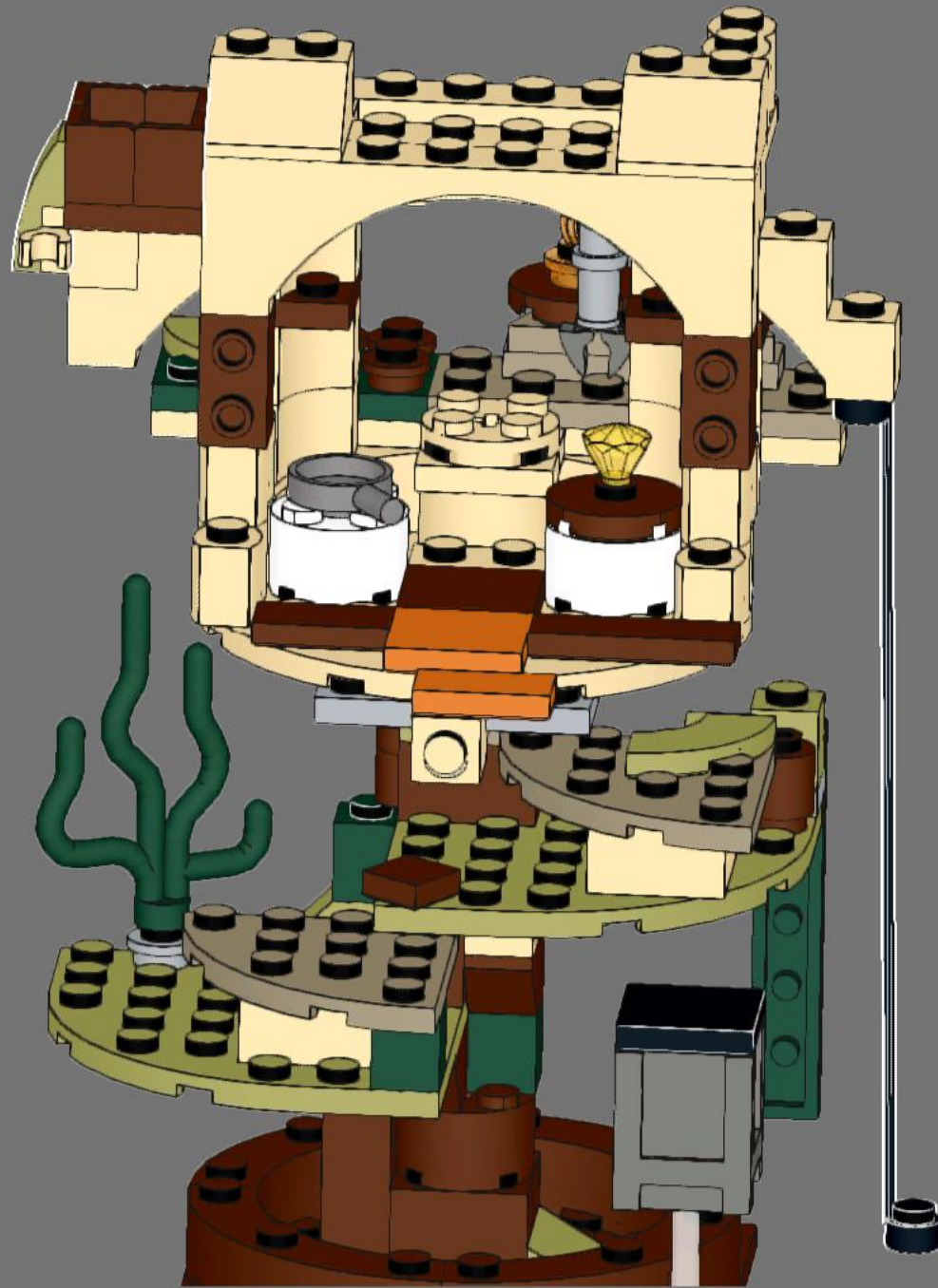
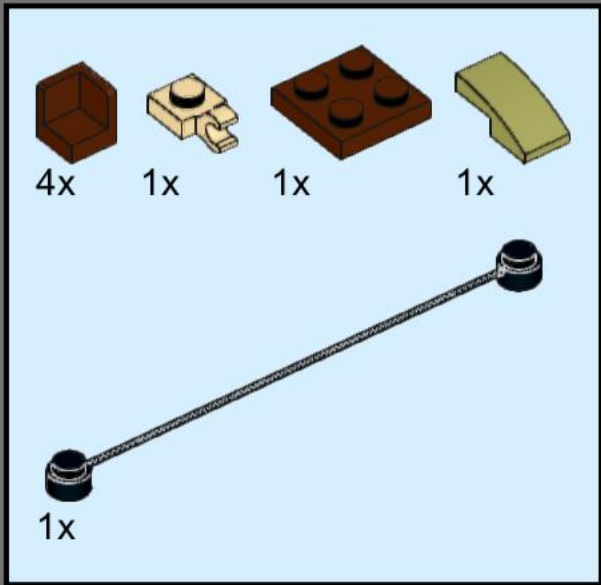

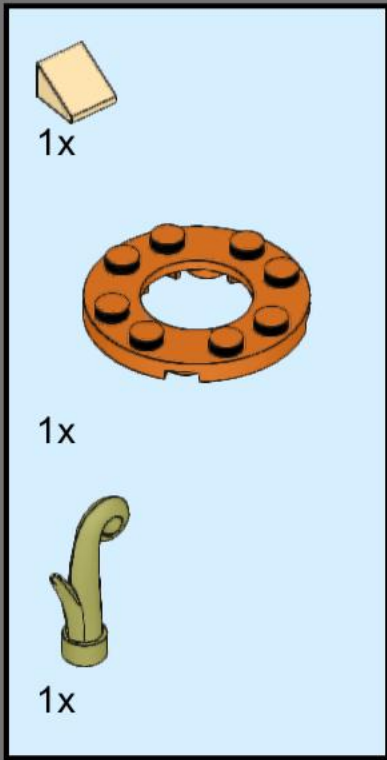

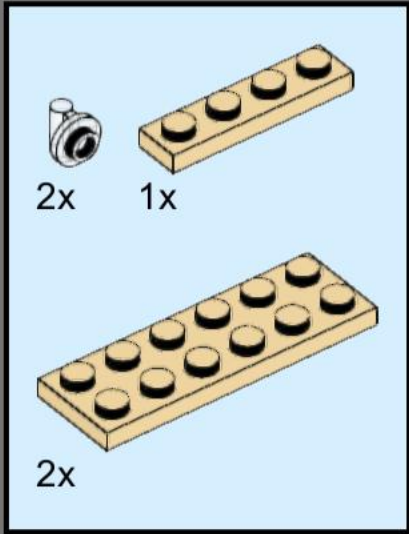

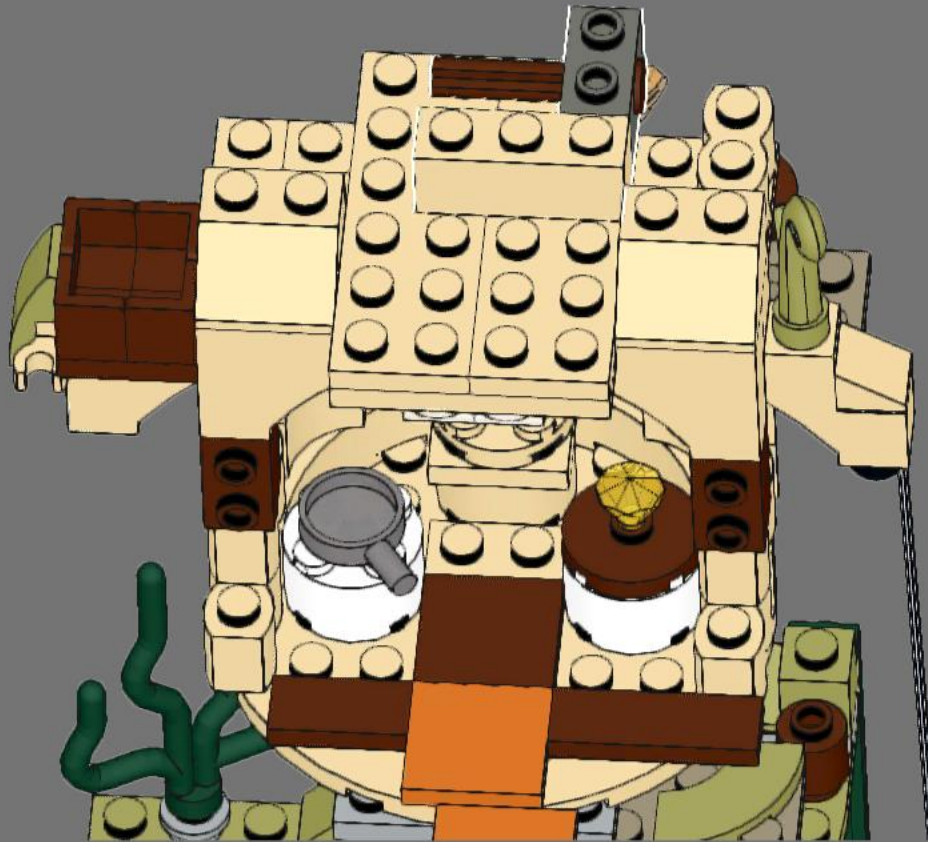
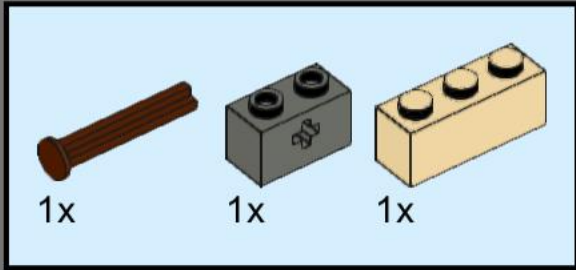

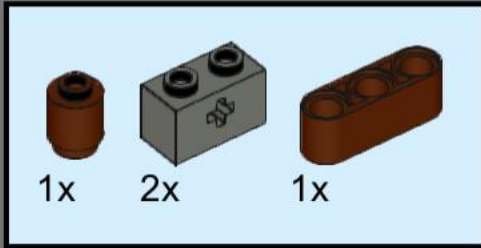

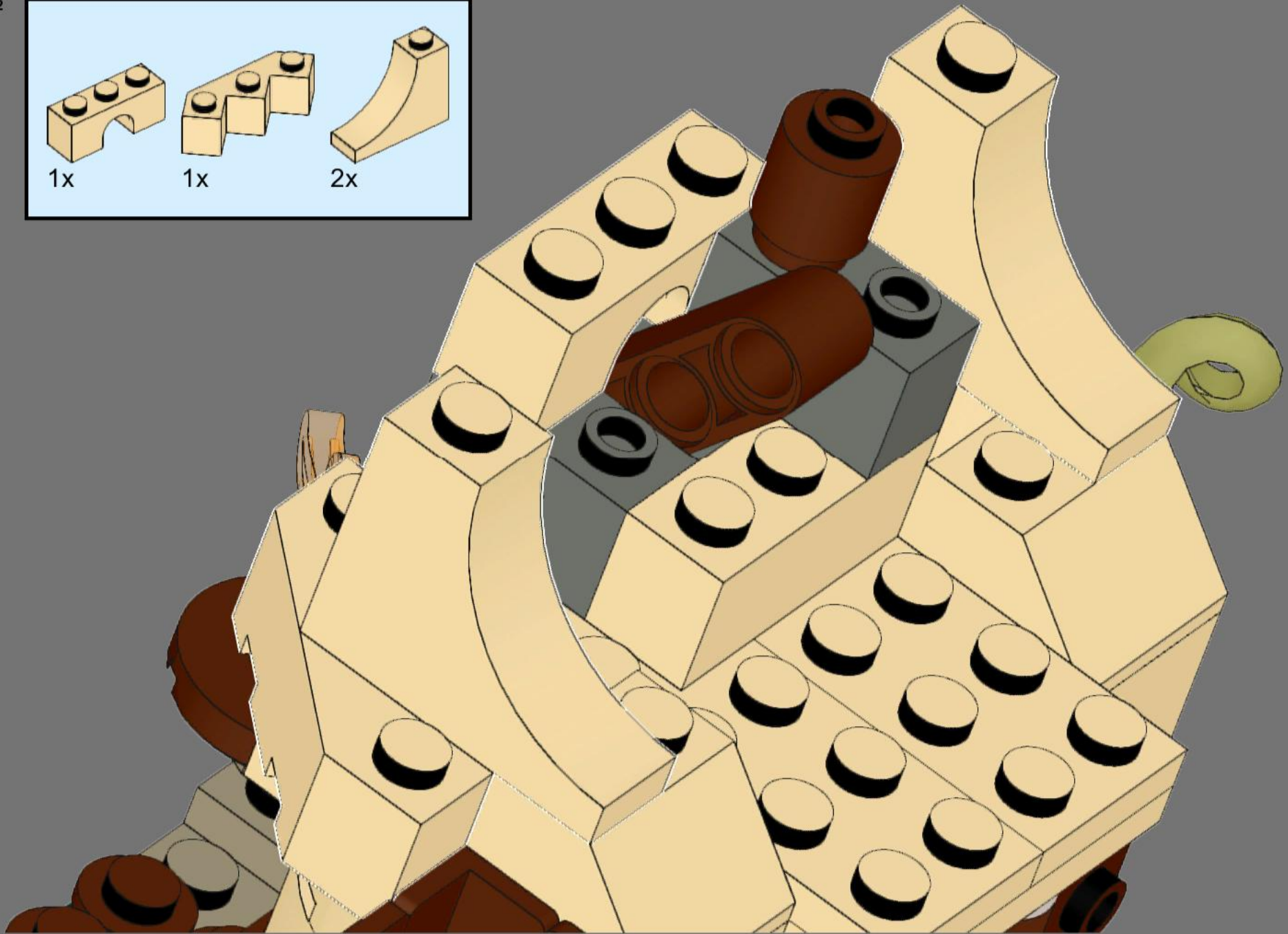
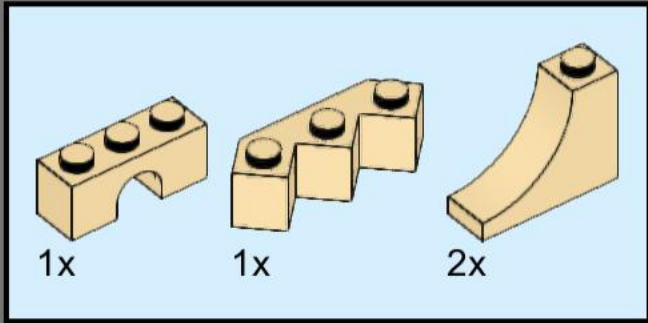

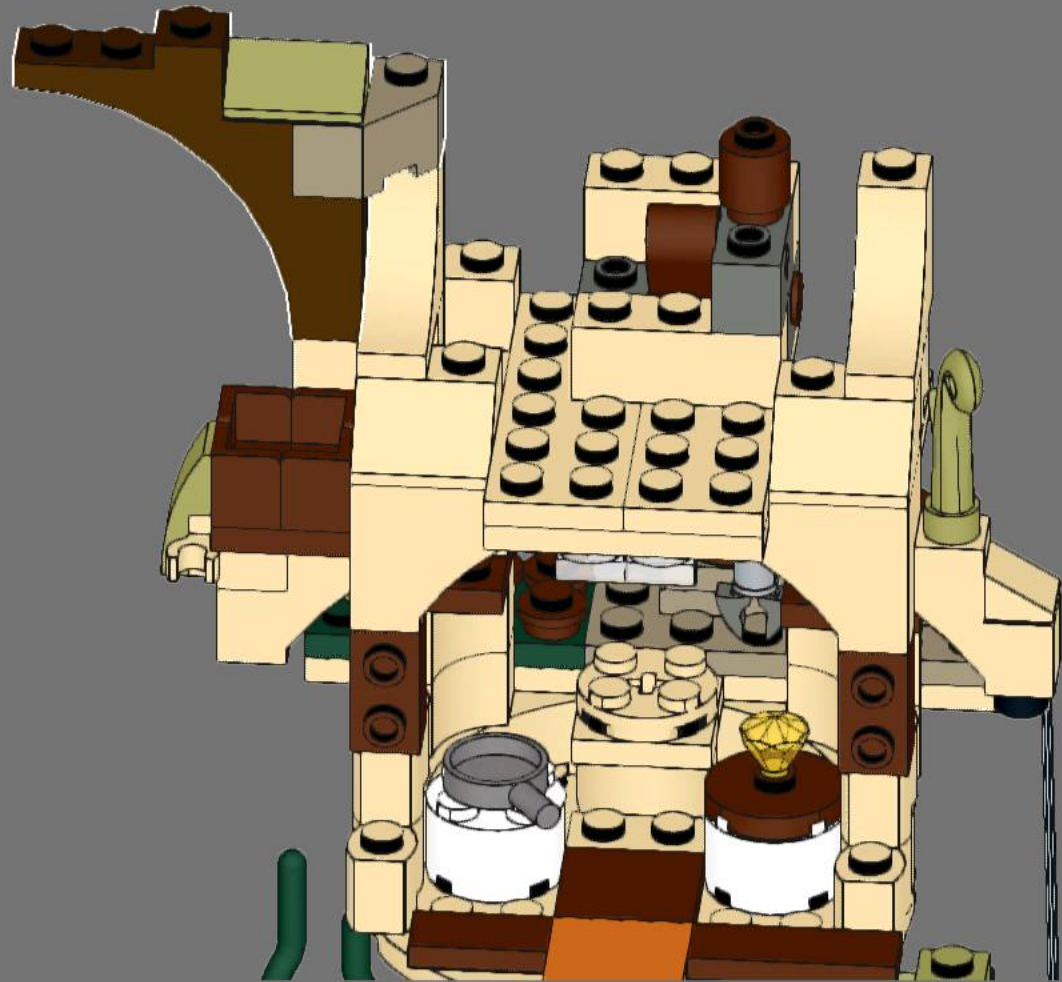
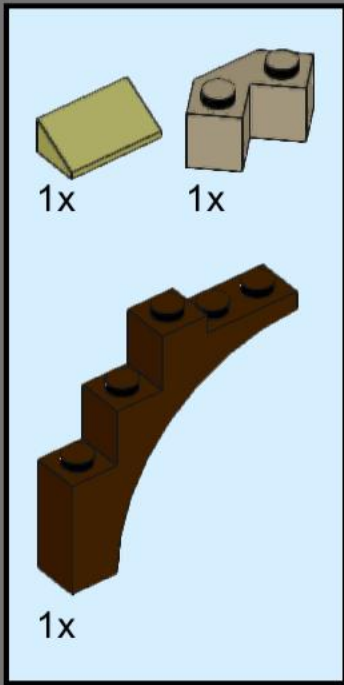

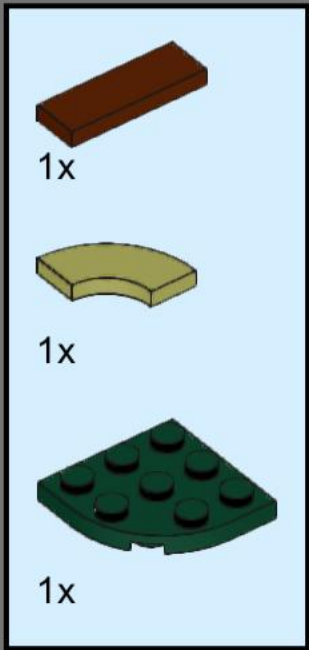

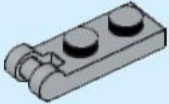

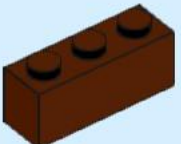
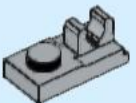

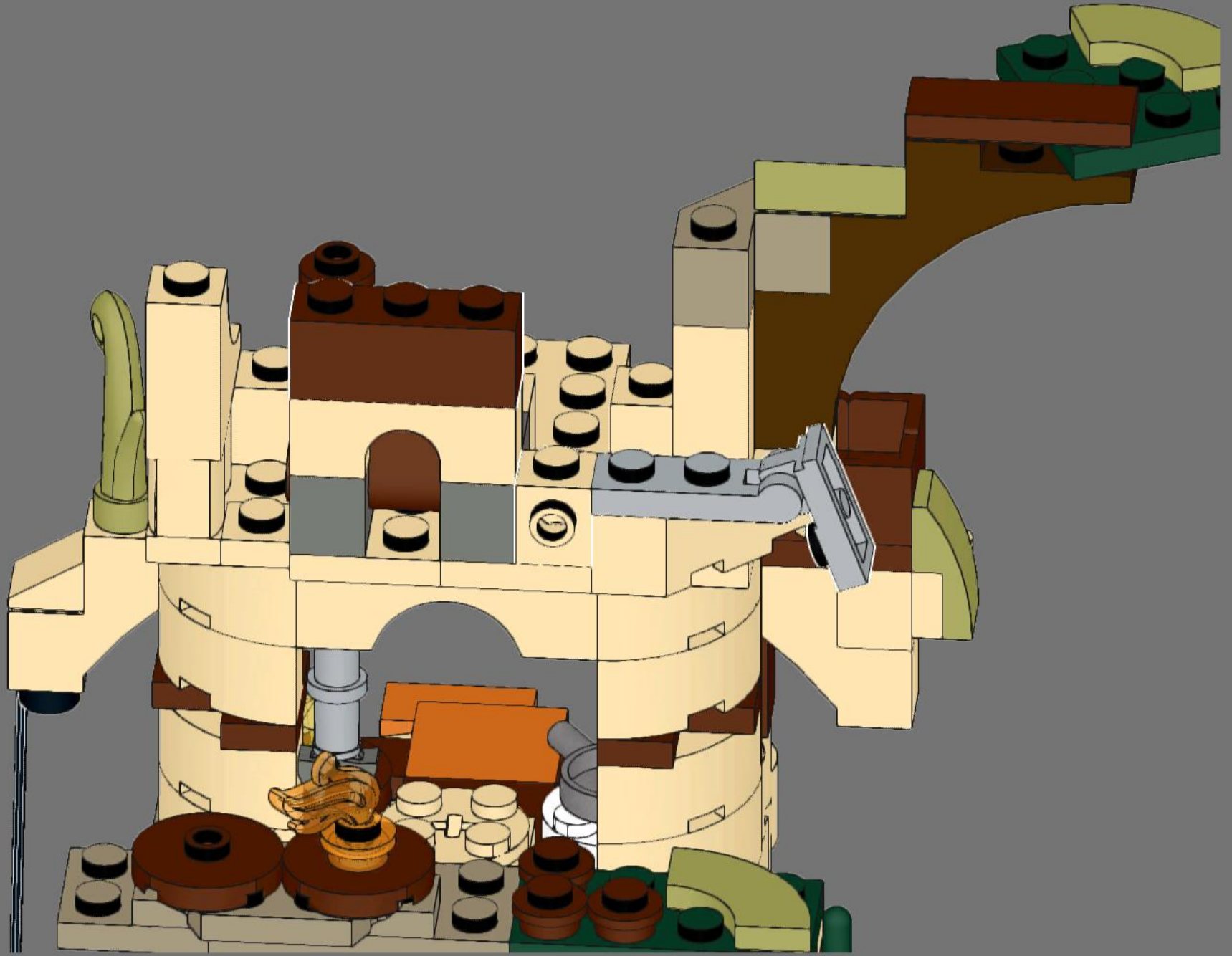

- 
1x
- 
1x
- 
1x
- 
1x



- 
1x
- 
1x
- 
1x

