

4x

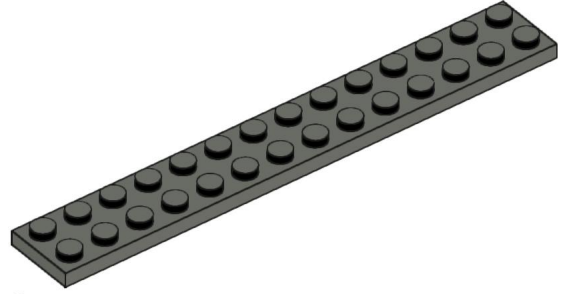

2x

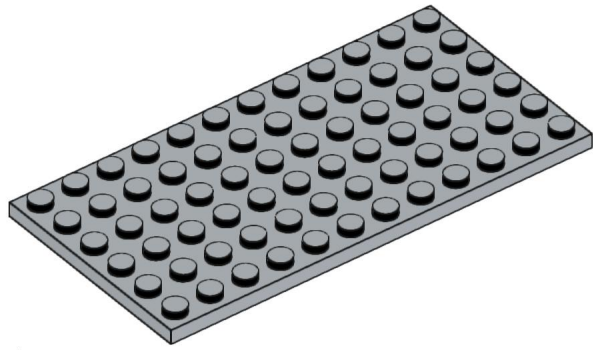

1x

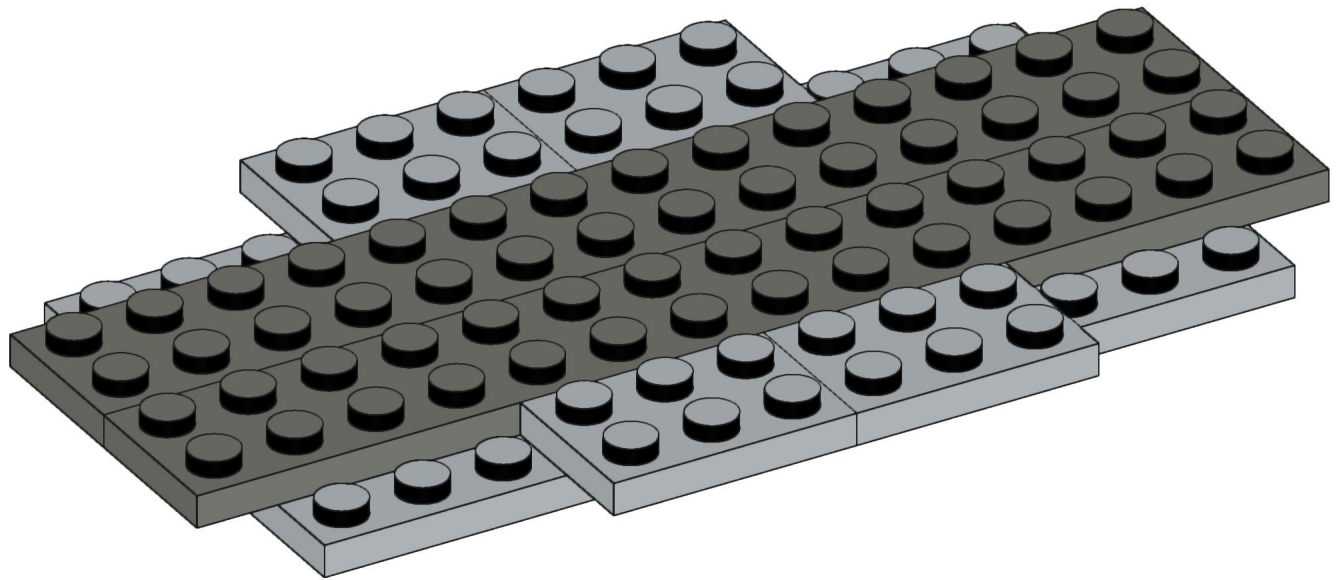

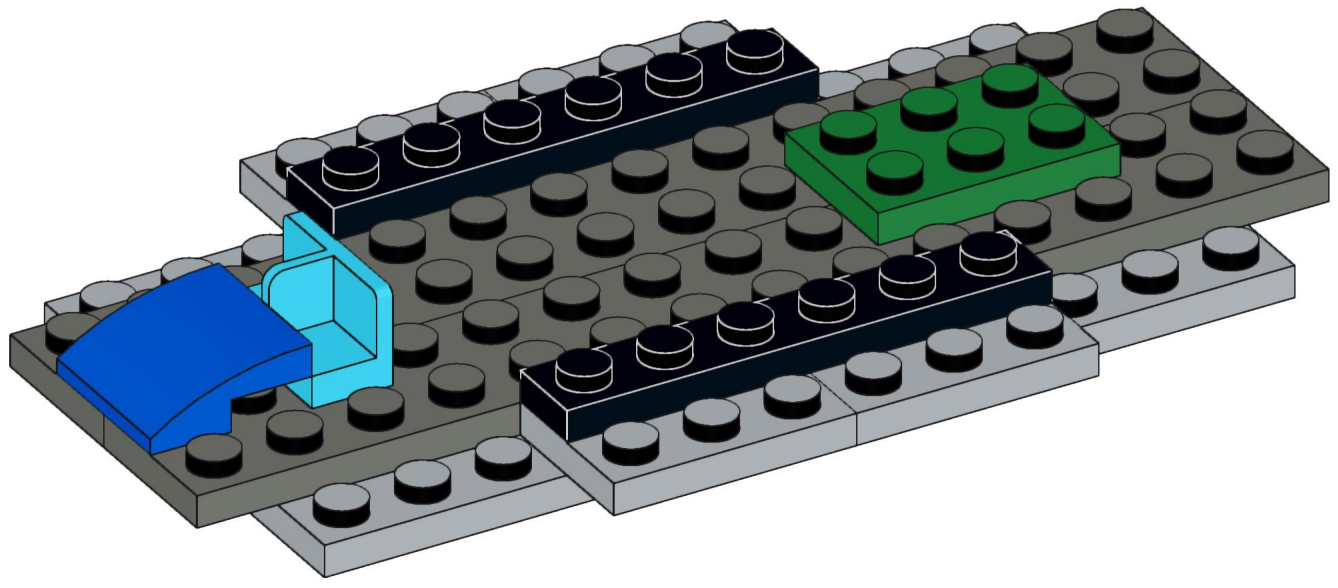
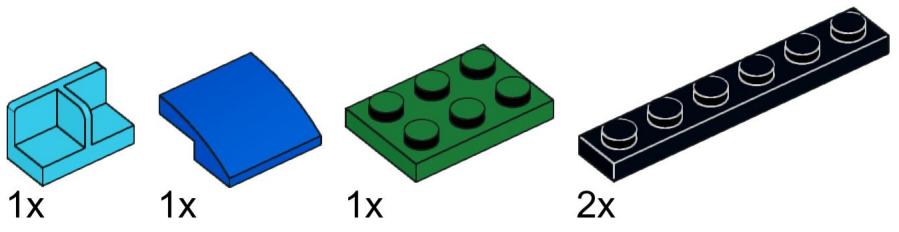

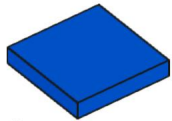

2x

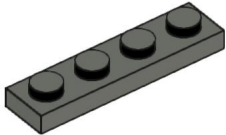

2x

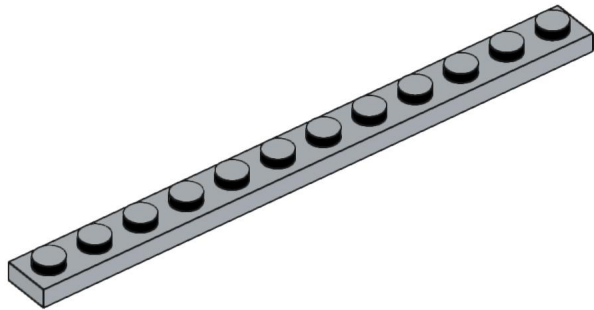

4x

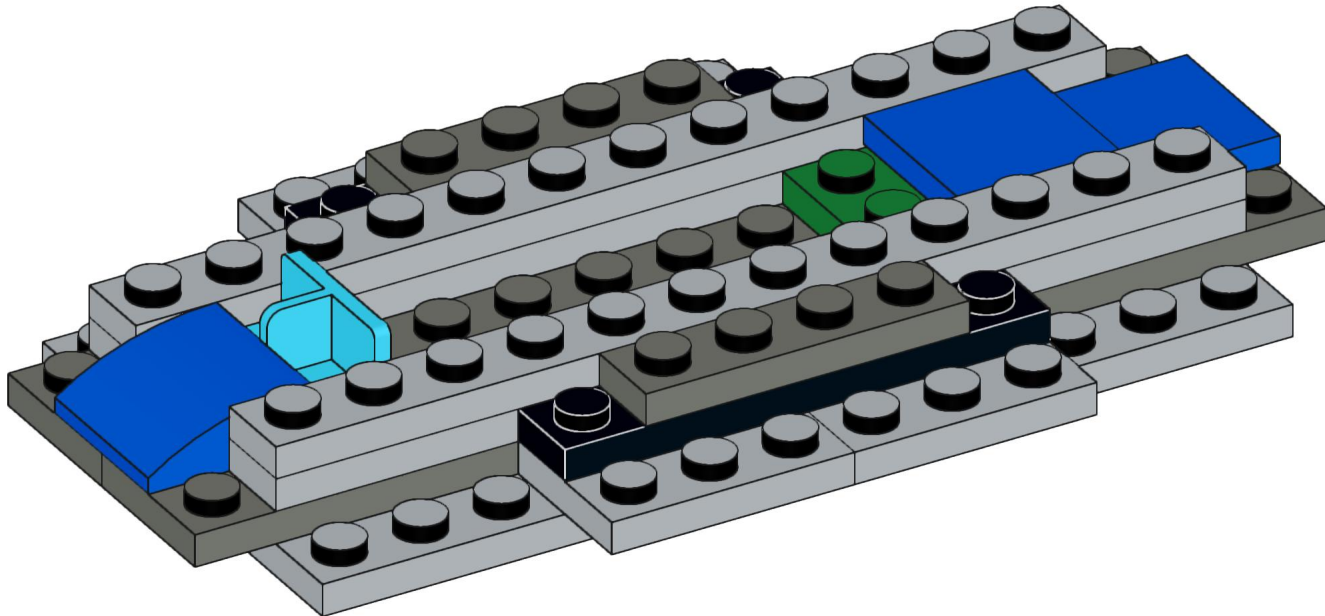

4

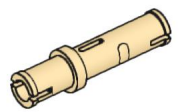

4x

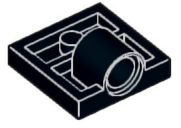

4x

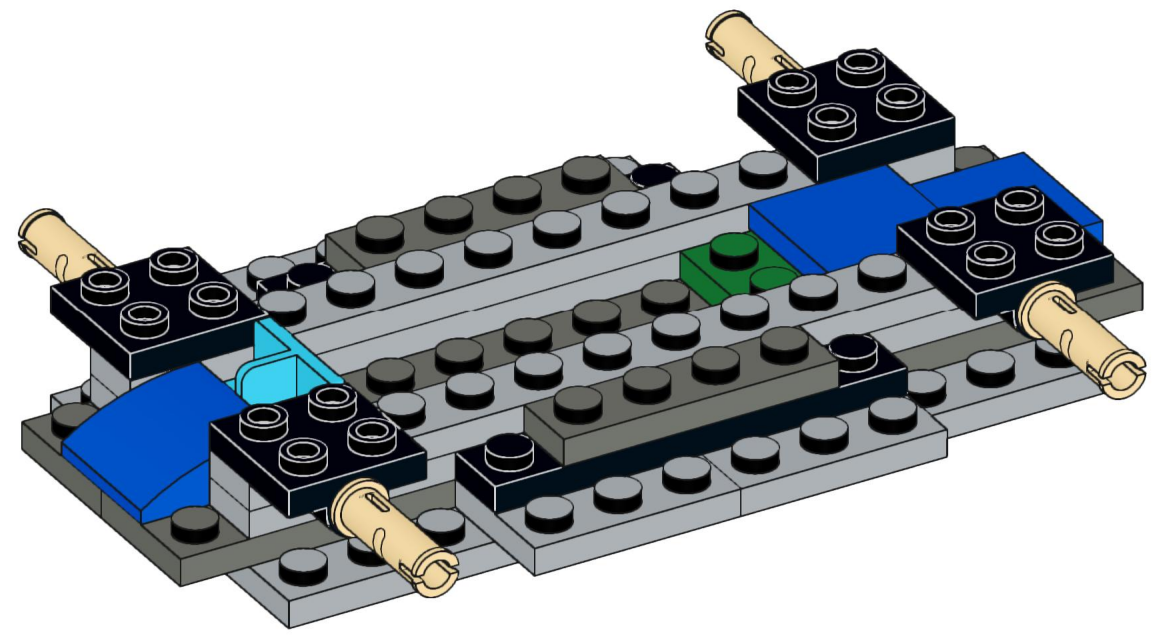

5

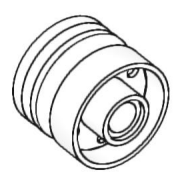



4x

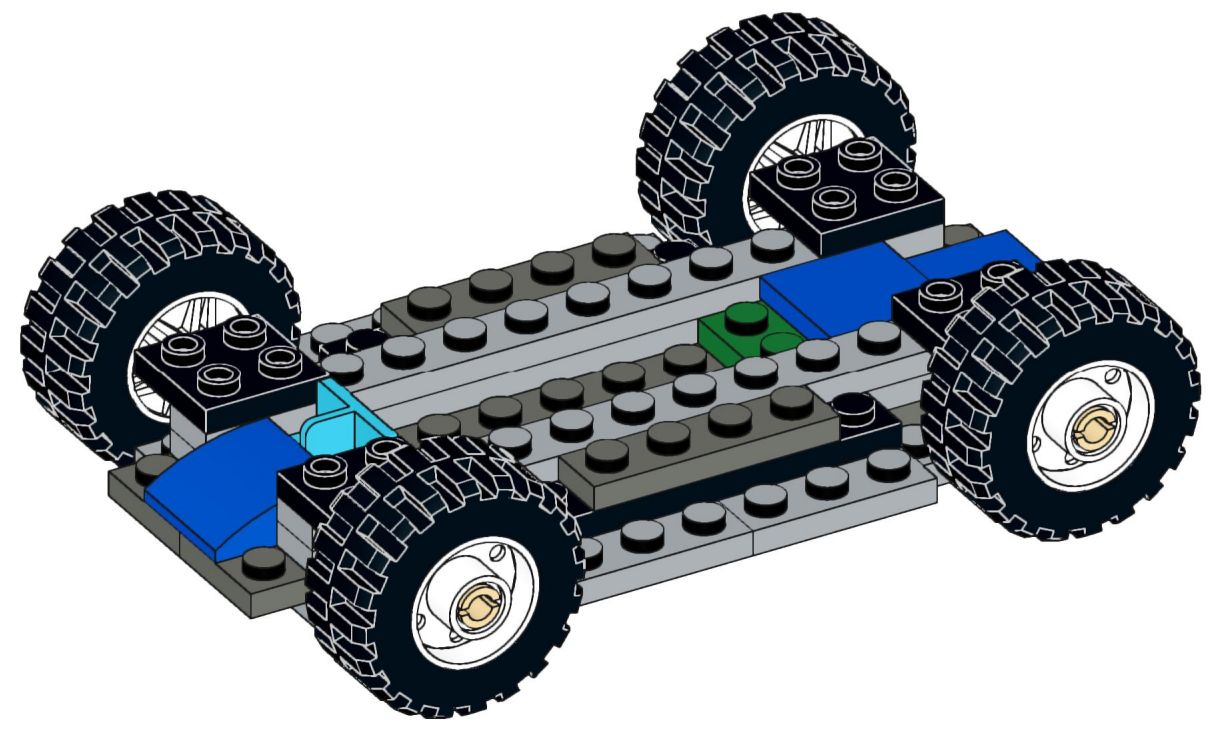

4x

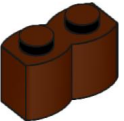
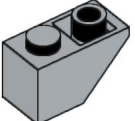

- 2x 
- 2x 
- 4x 
- 2x 

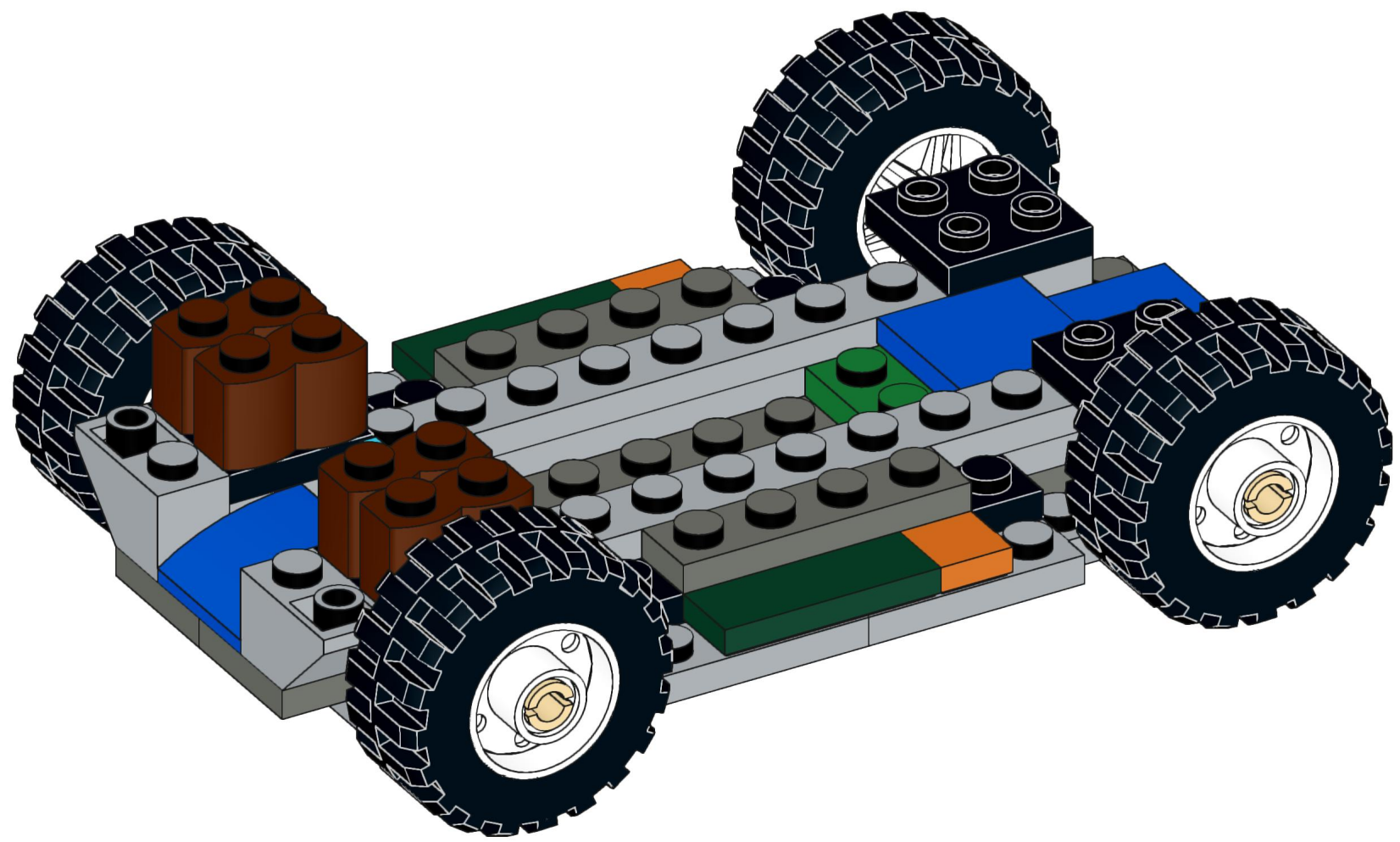



2x



2x

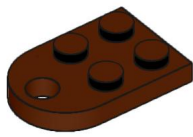

2x

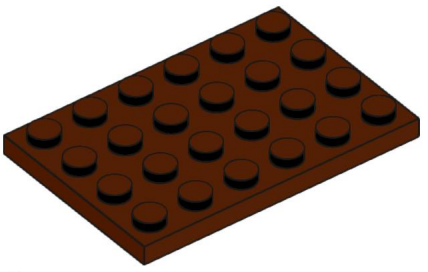



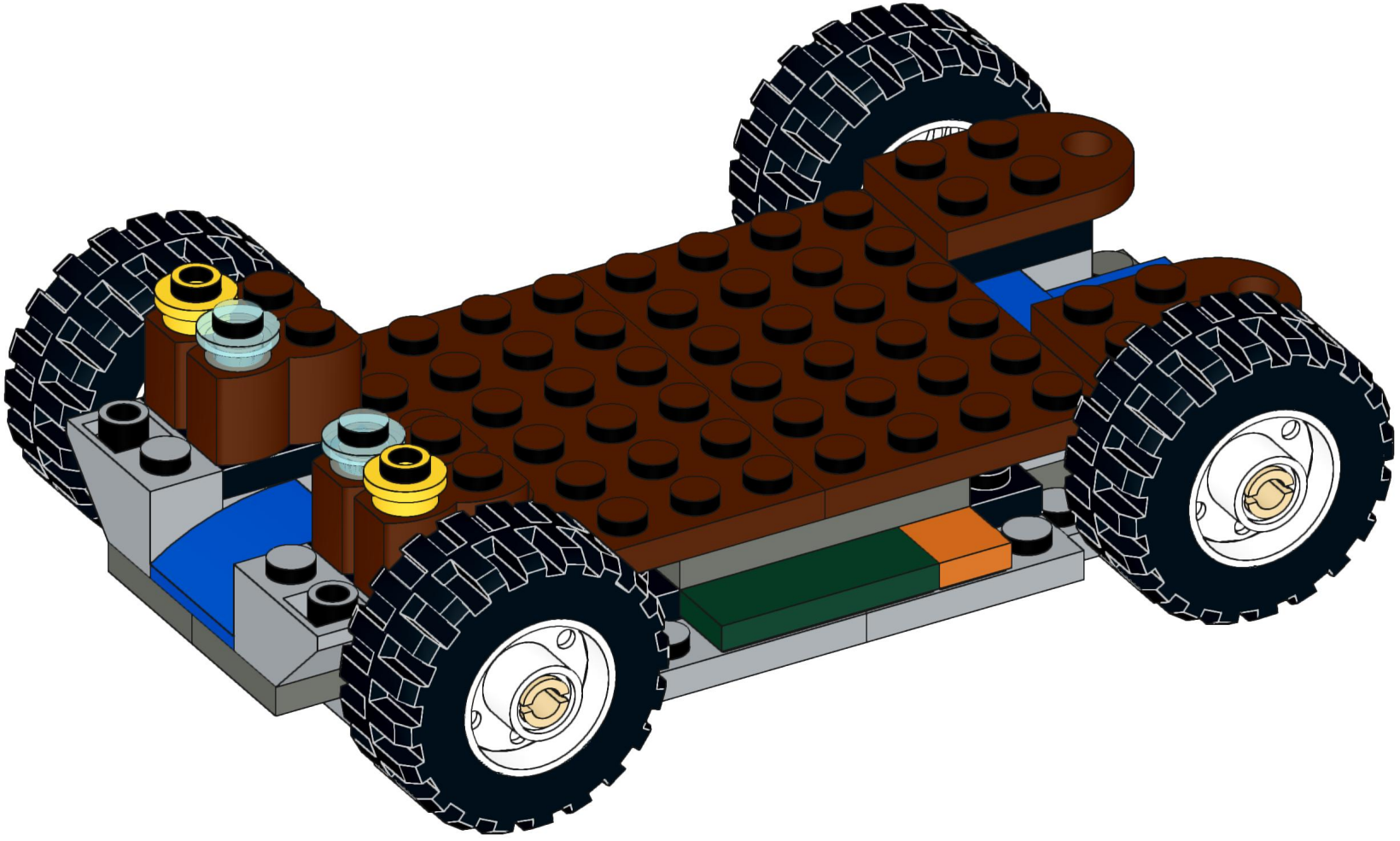

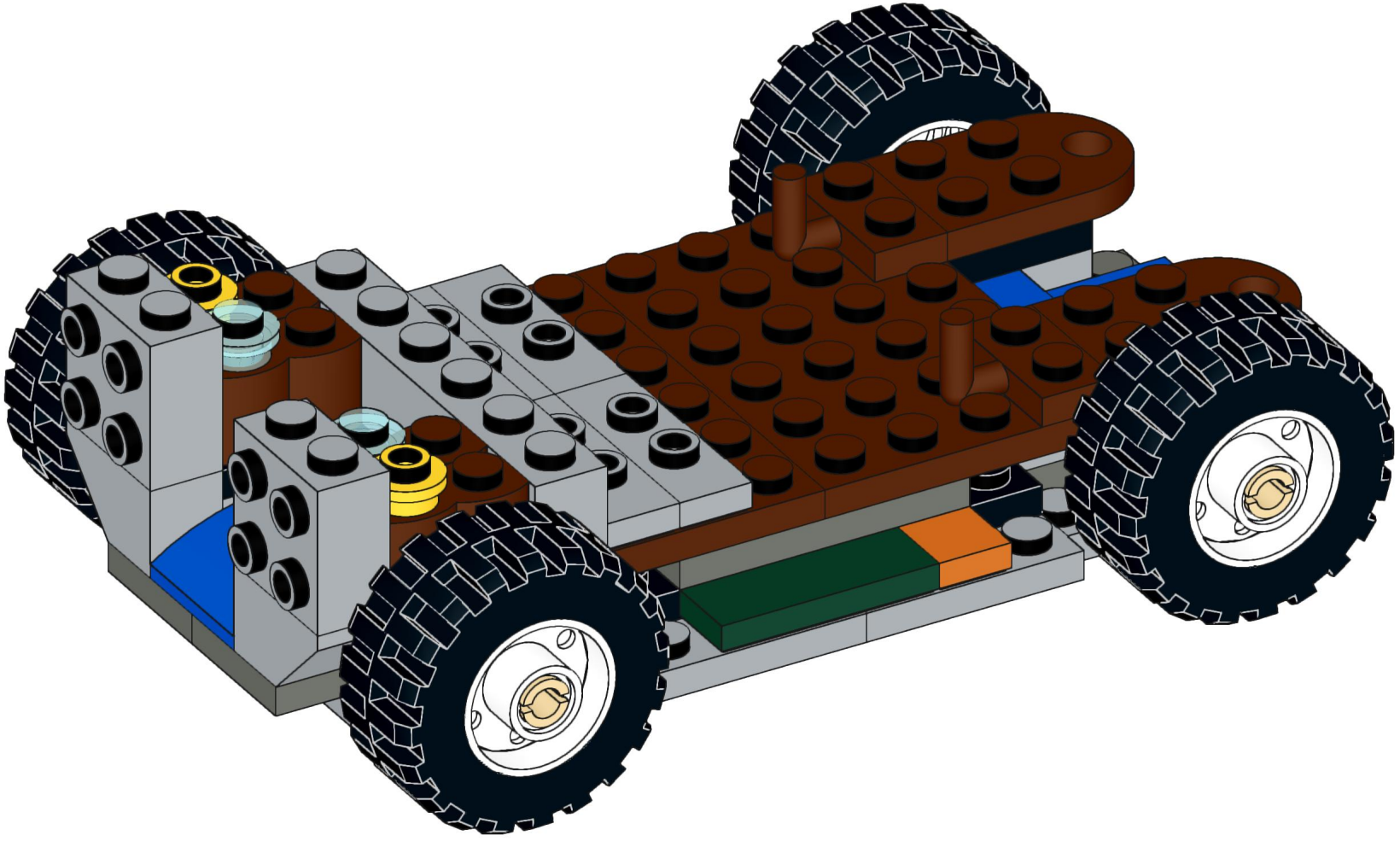
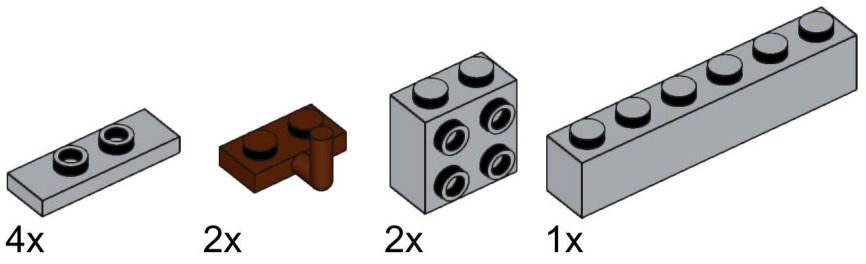
2x

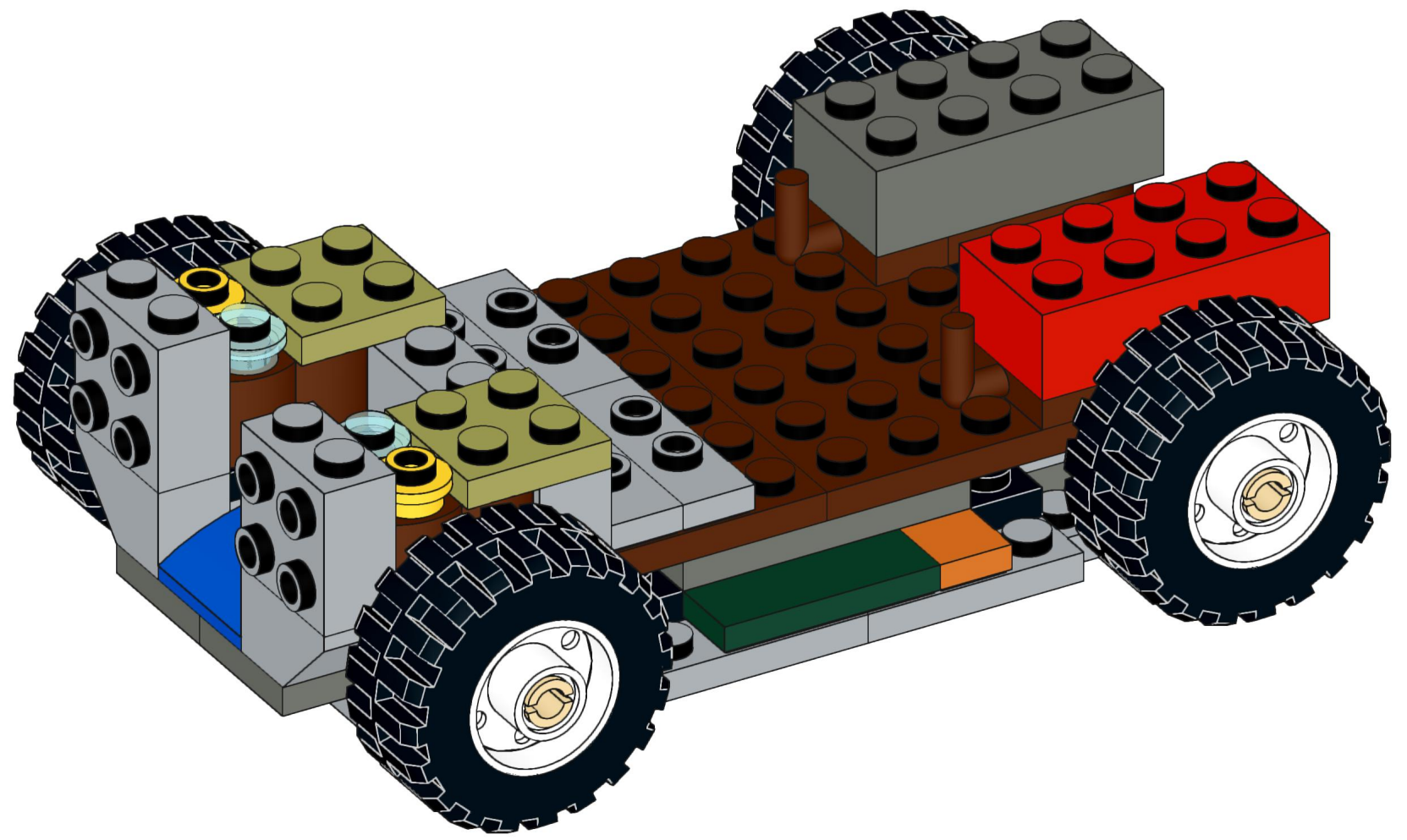
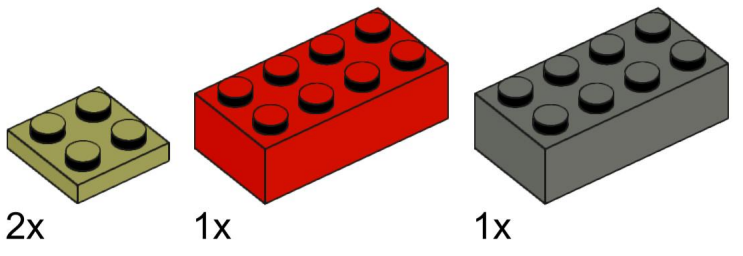





- 1x 
- 1x 
- 1x 
- 4x 

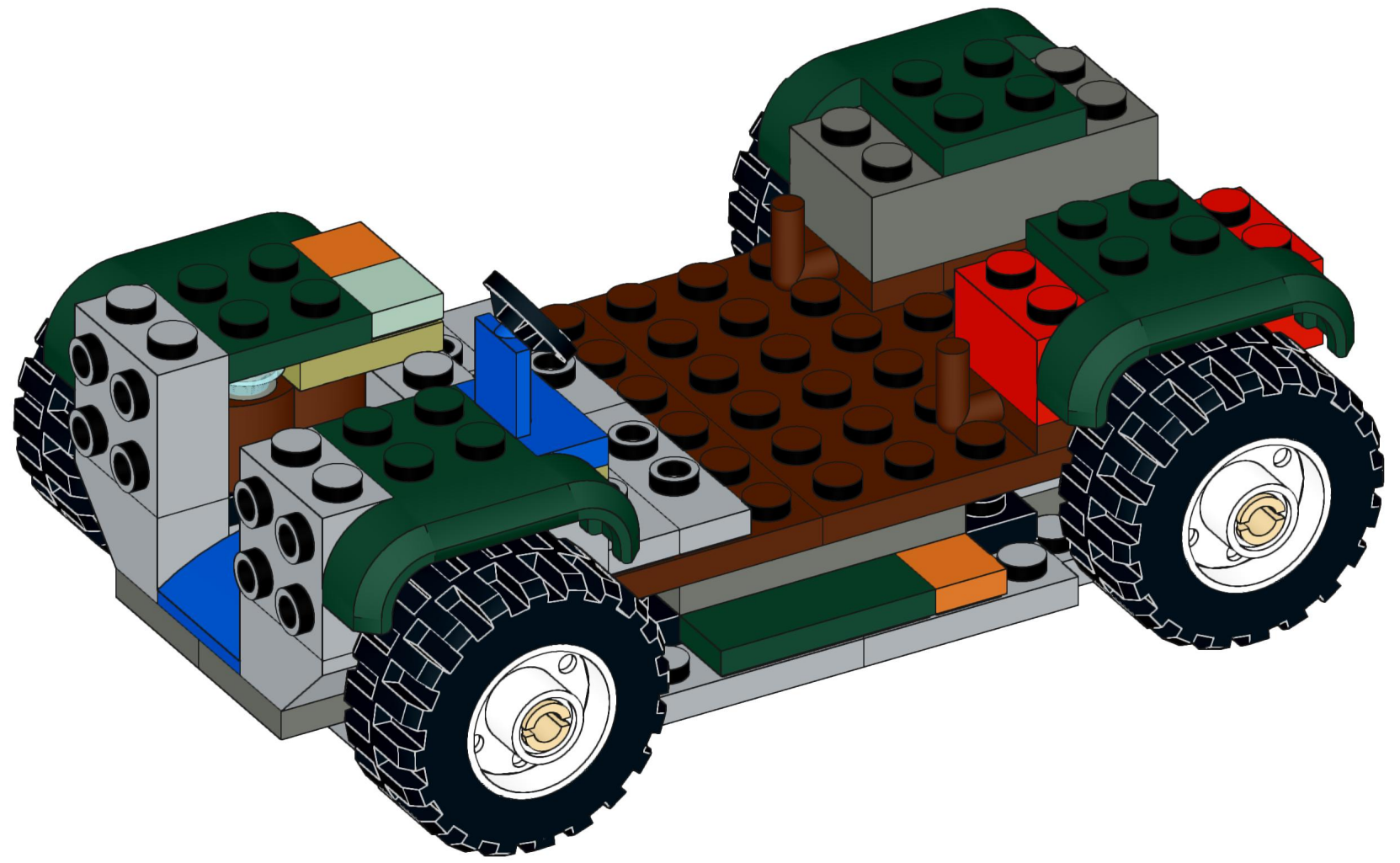

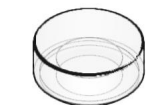

1x



1x



1x



1x

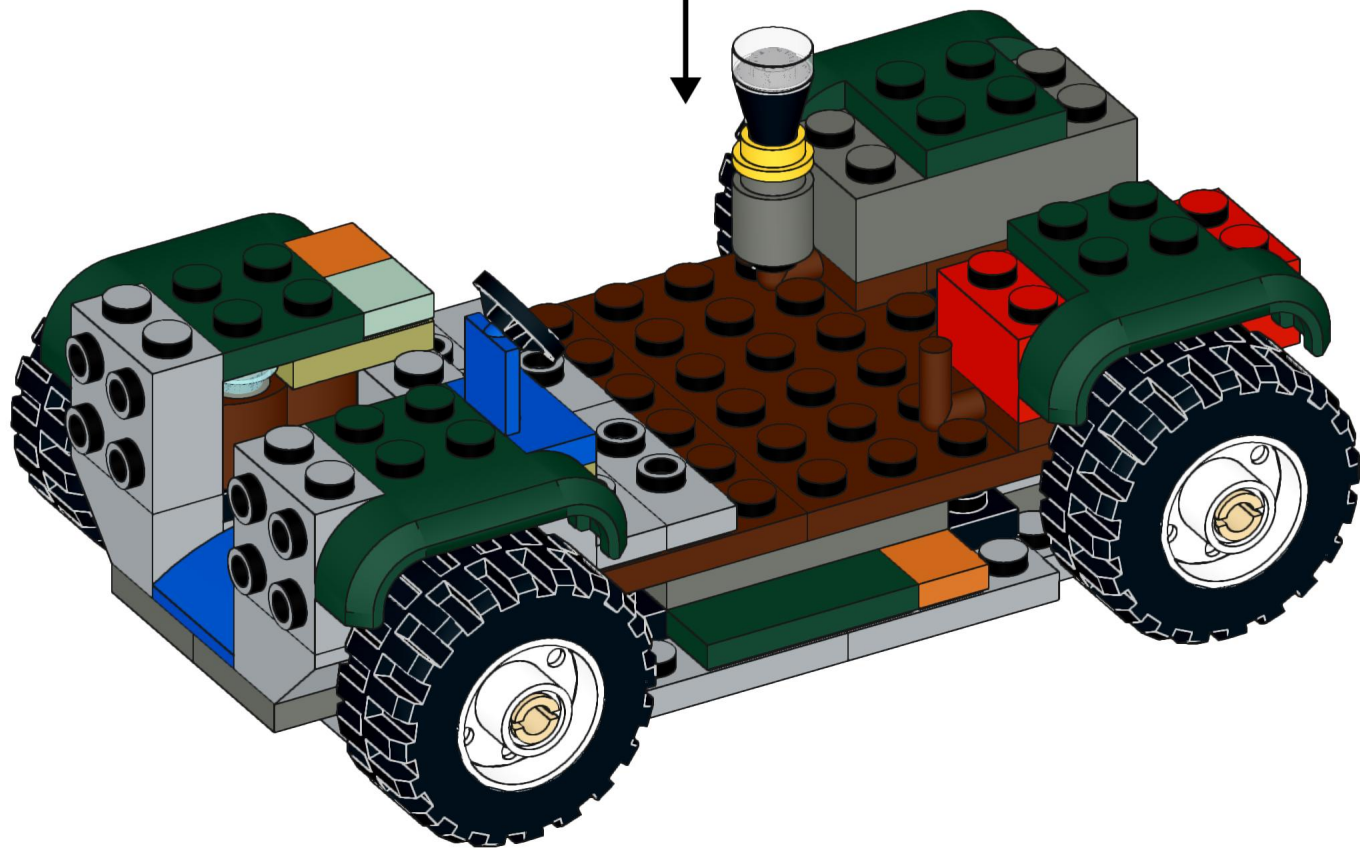
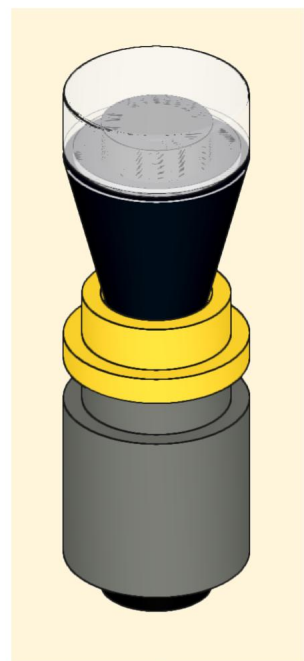

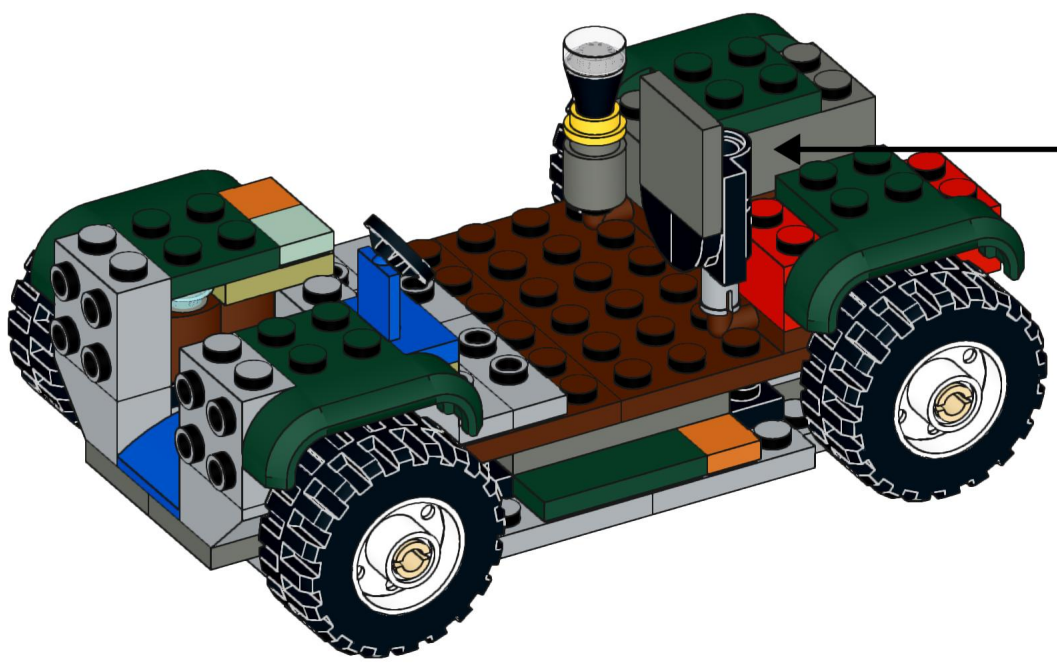
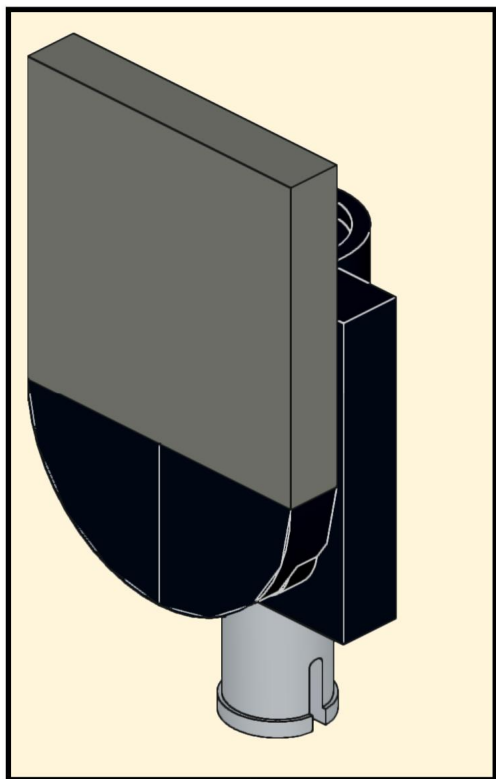
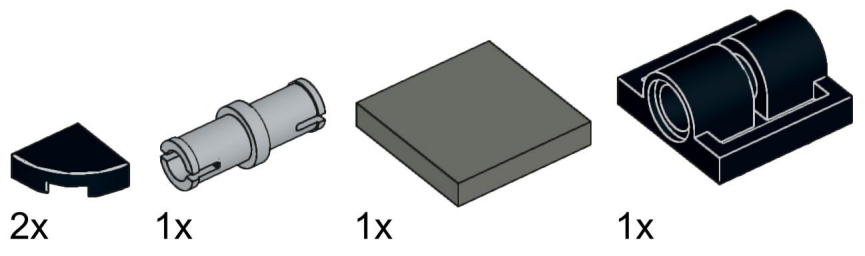

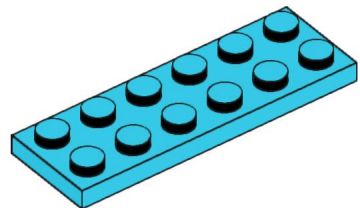

1x

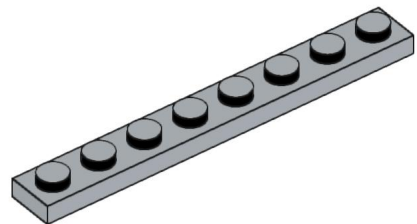

1x

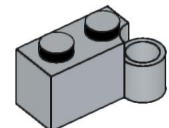
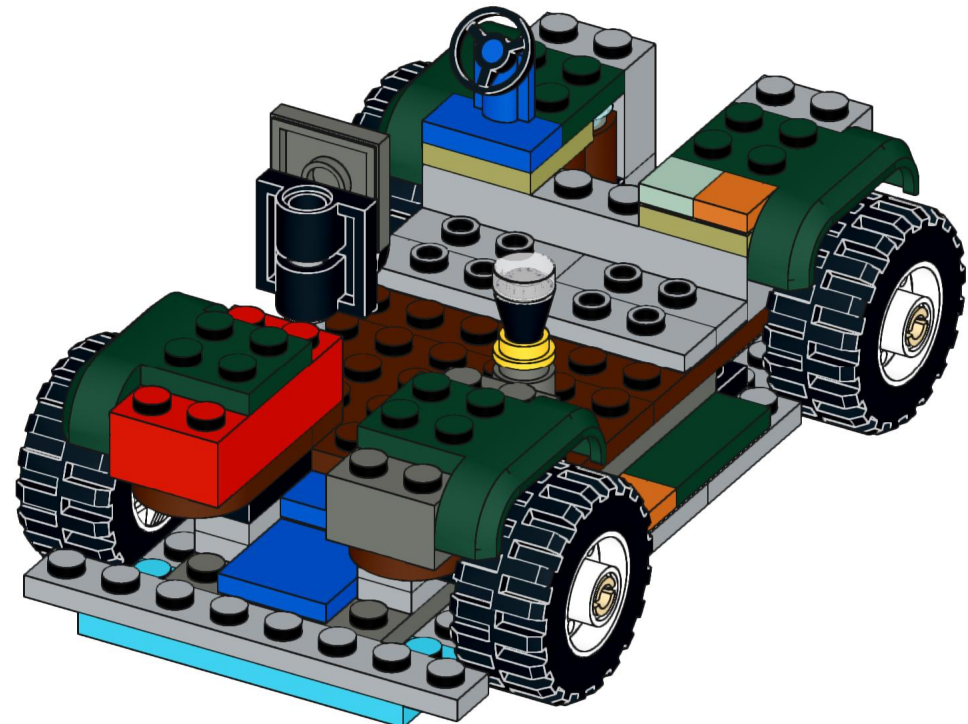

2x

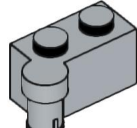

2x

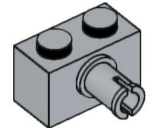

2x

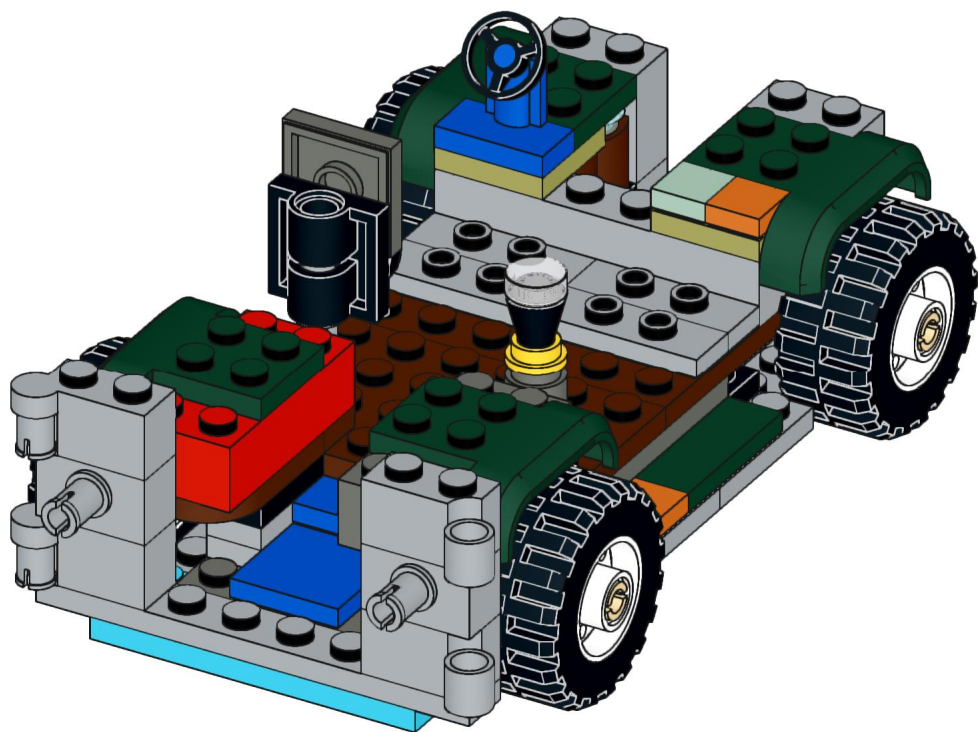

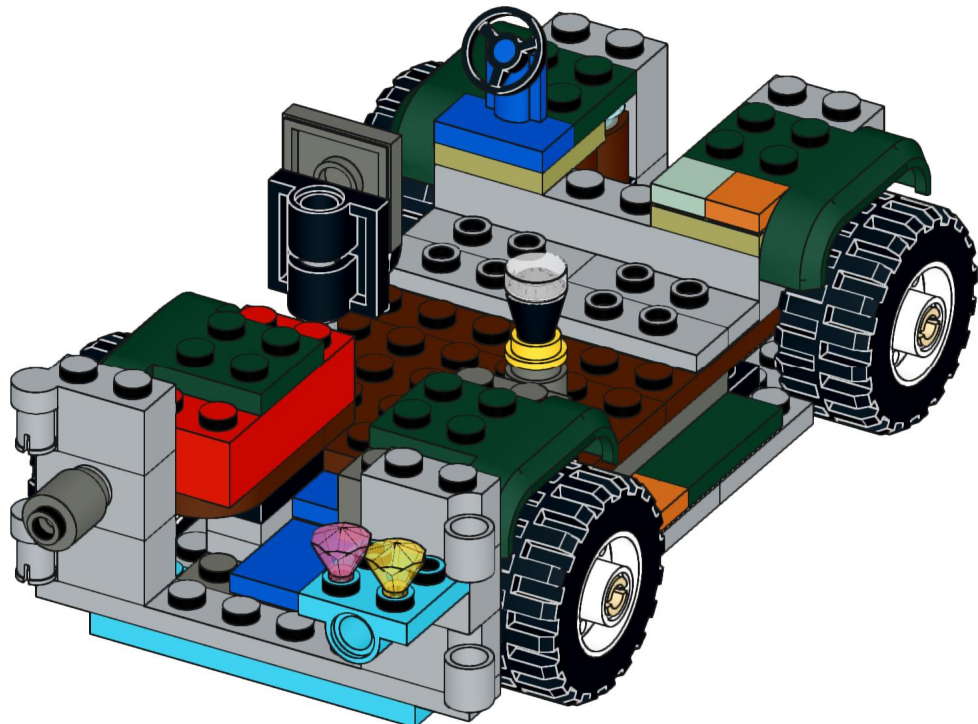
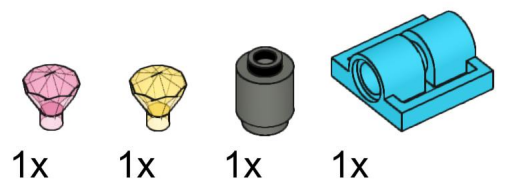

15

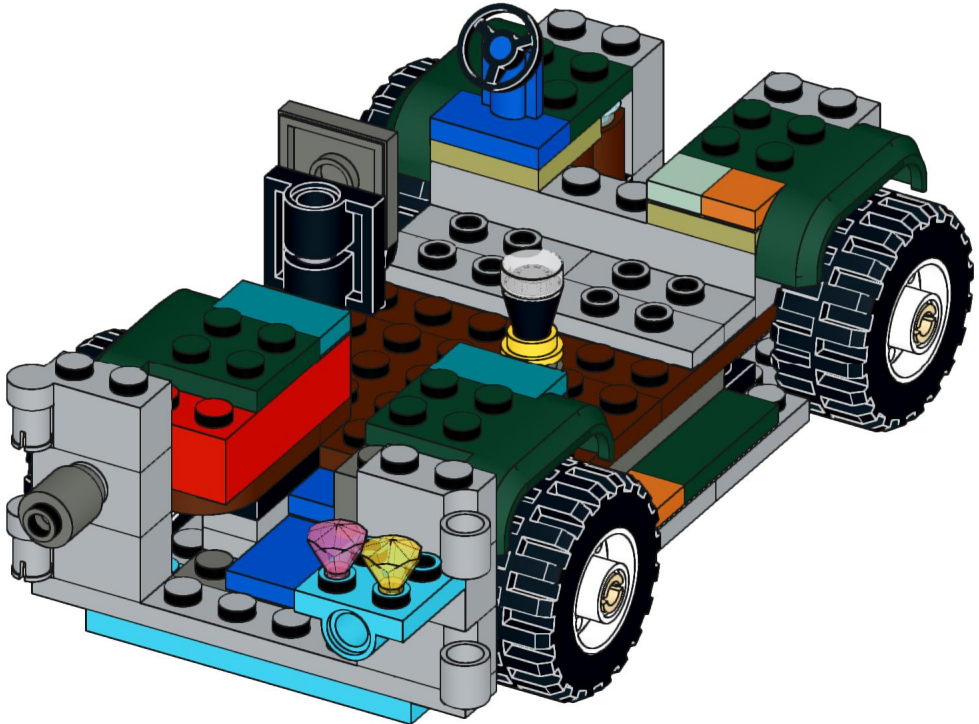
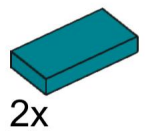

16

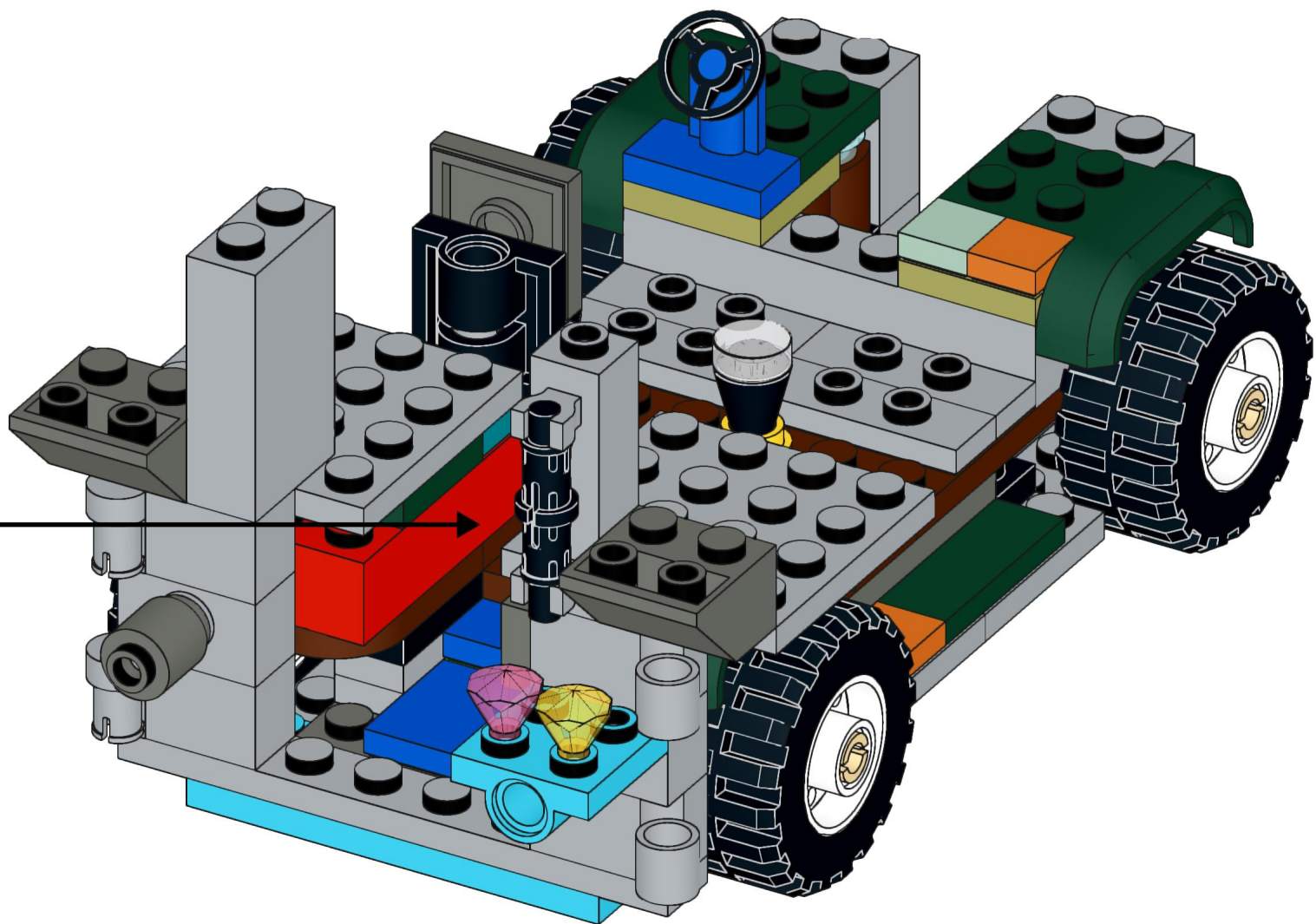
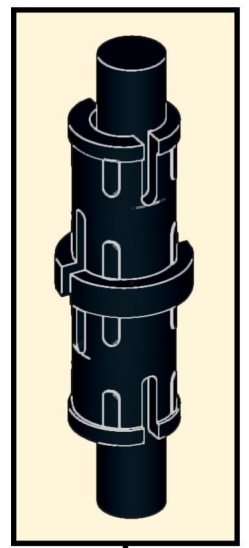
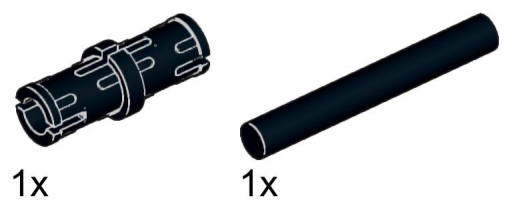



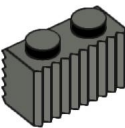
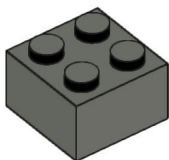

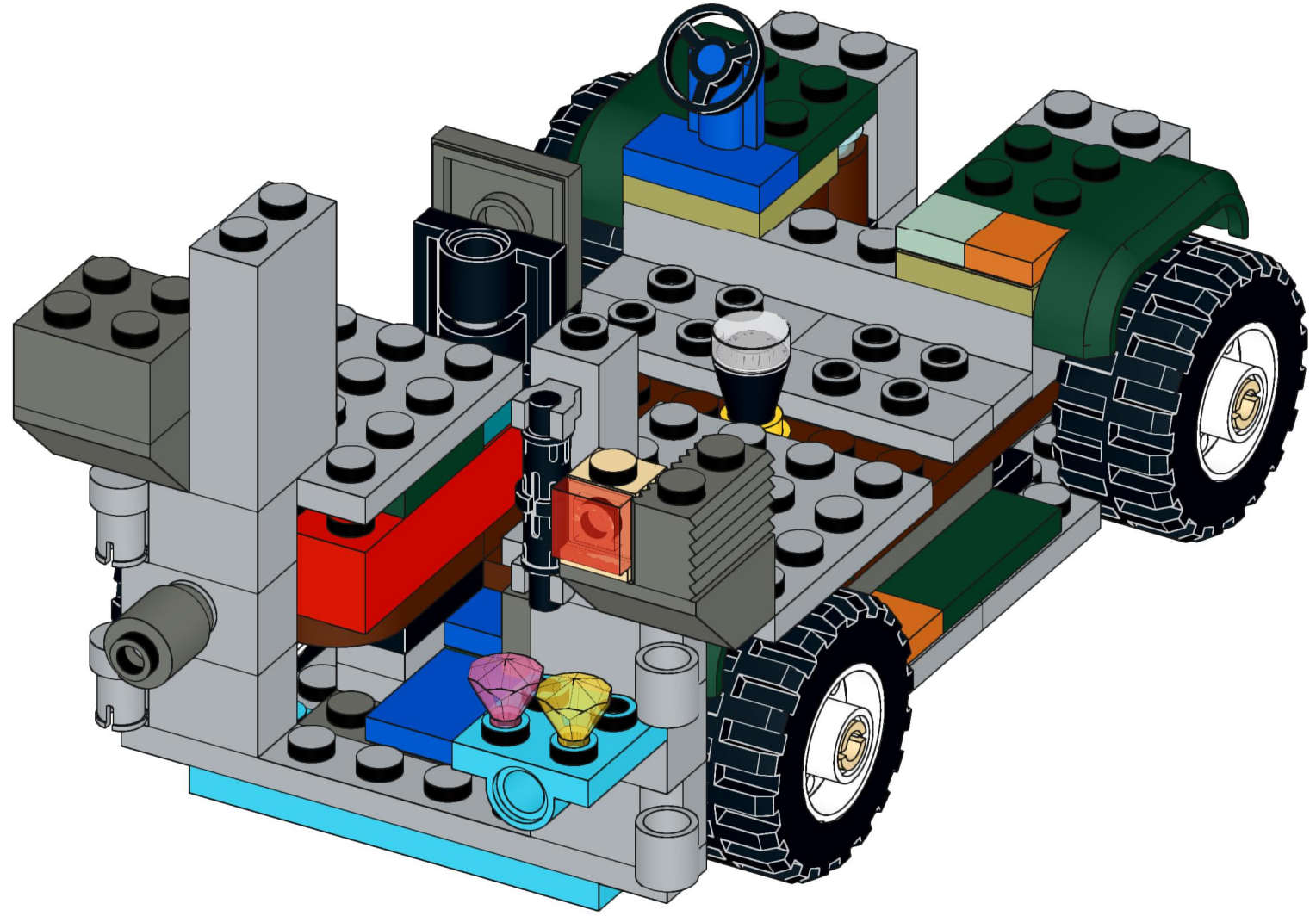
- 1x 
- 1x 
- 1x 
- 1x 

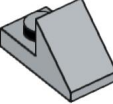
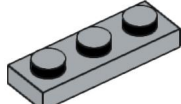
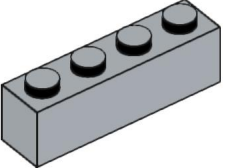

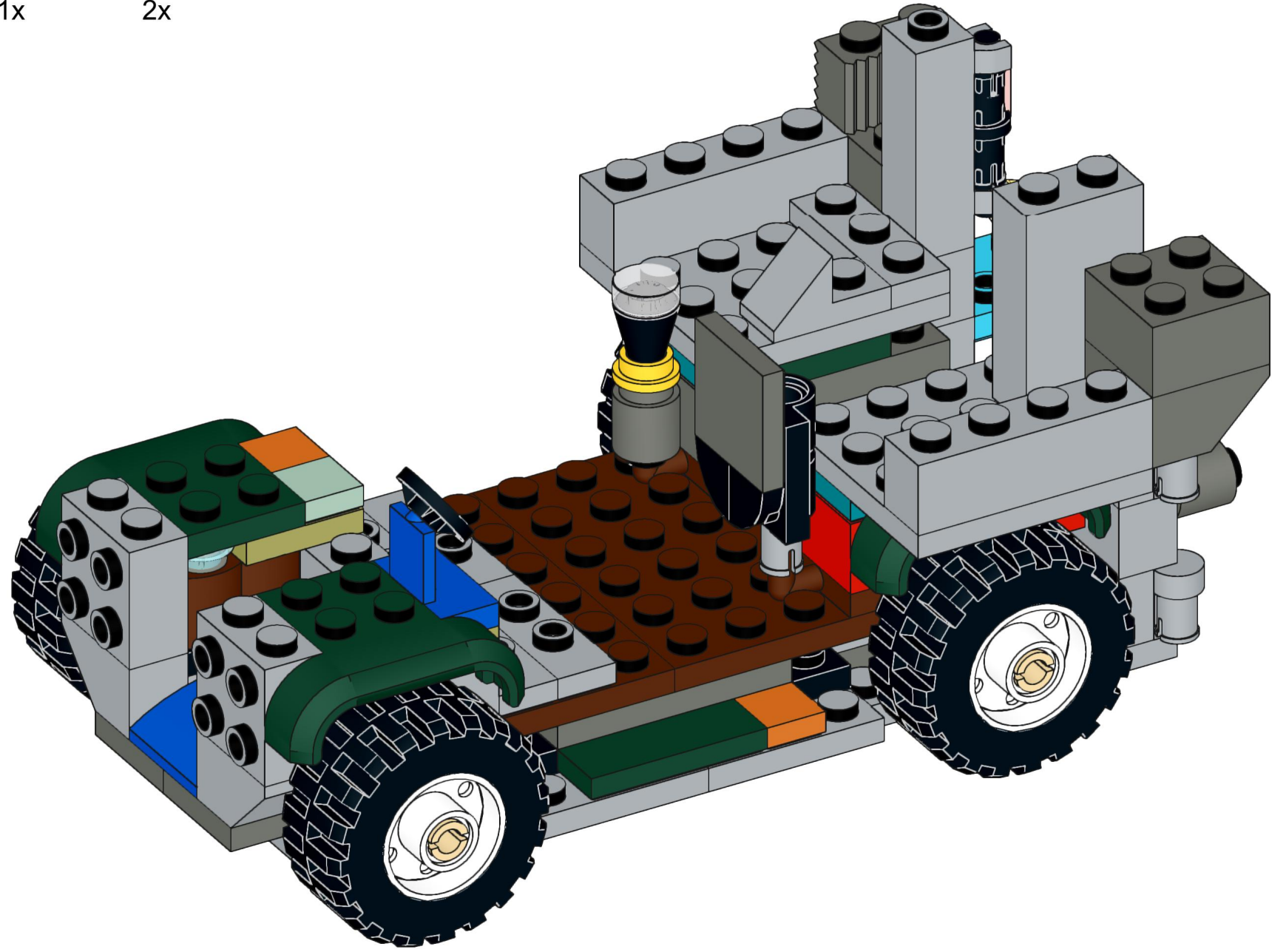

- 1x 
- 1x 
- 2x 

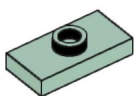
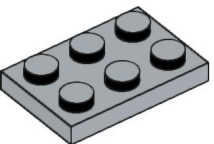

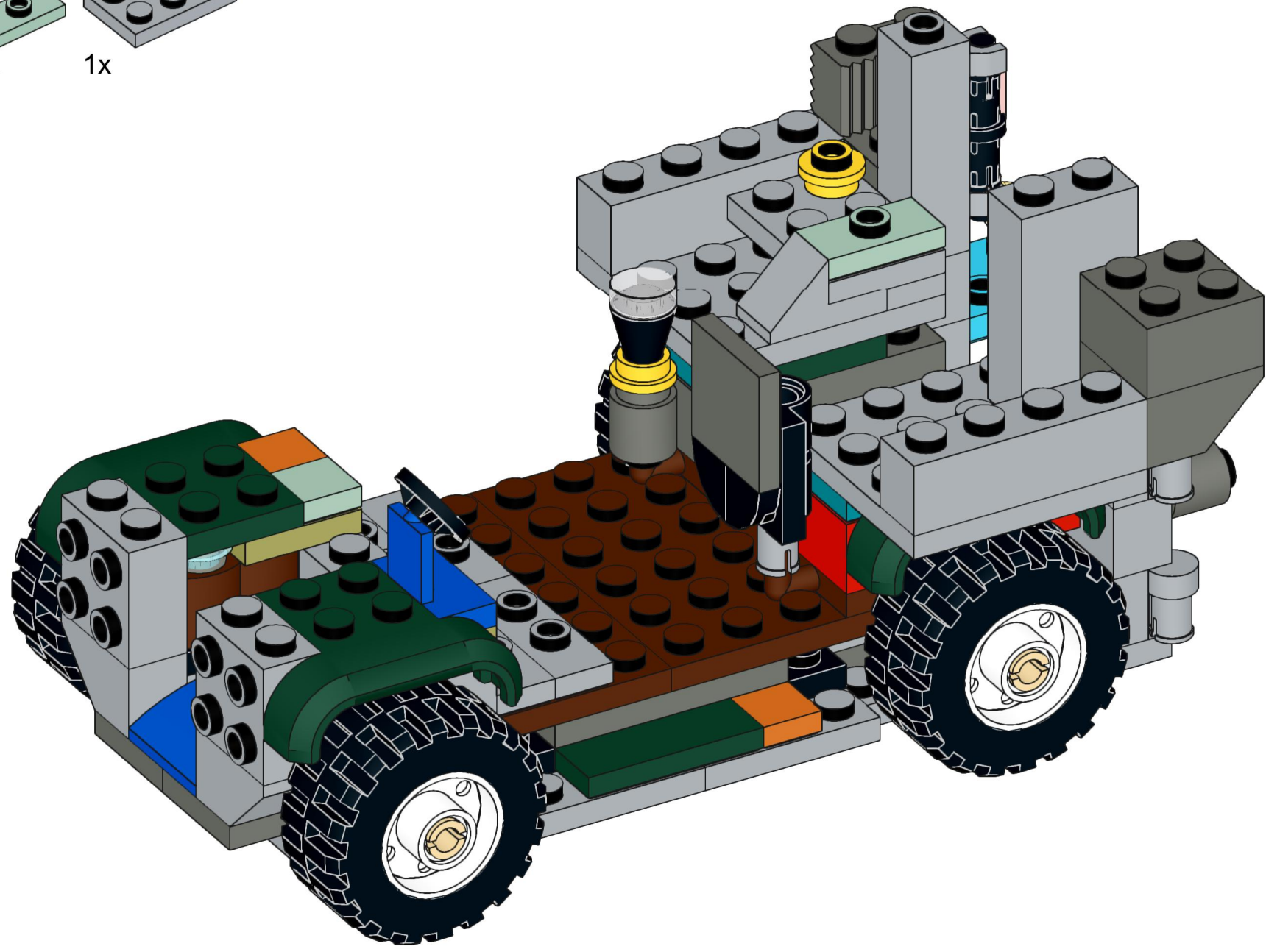
- 1x 
- 1x 
- 1x 



- 1x 
- 1x 
- 1x 

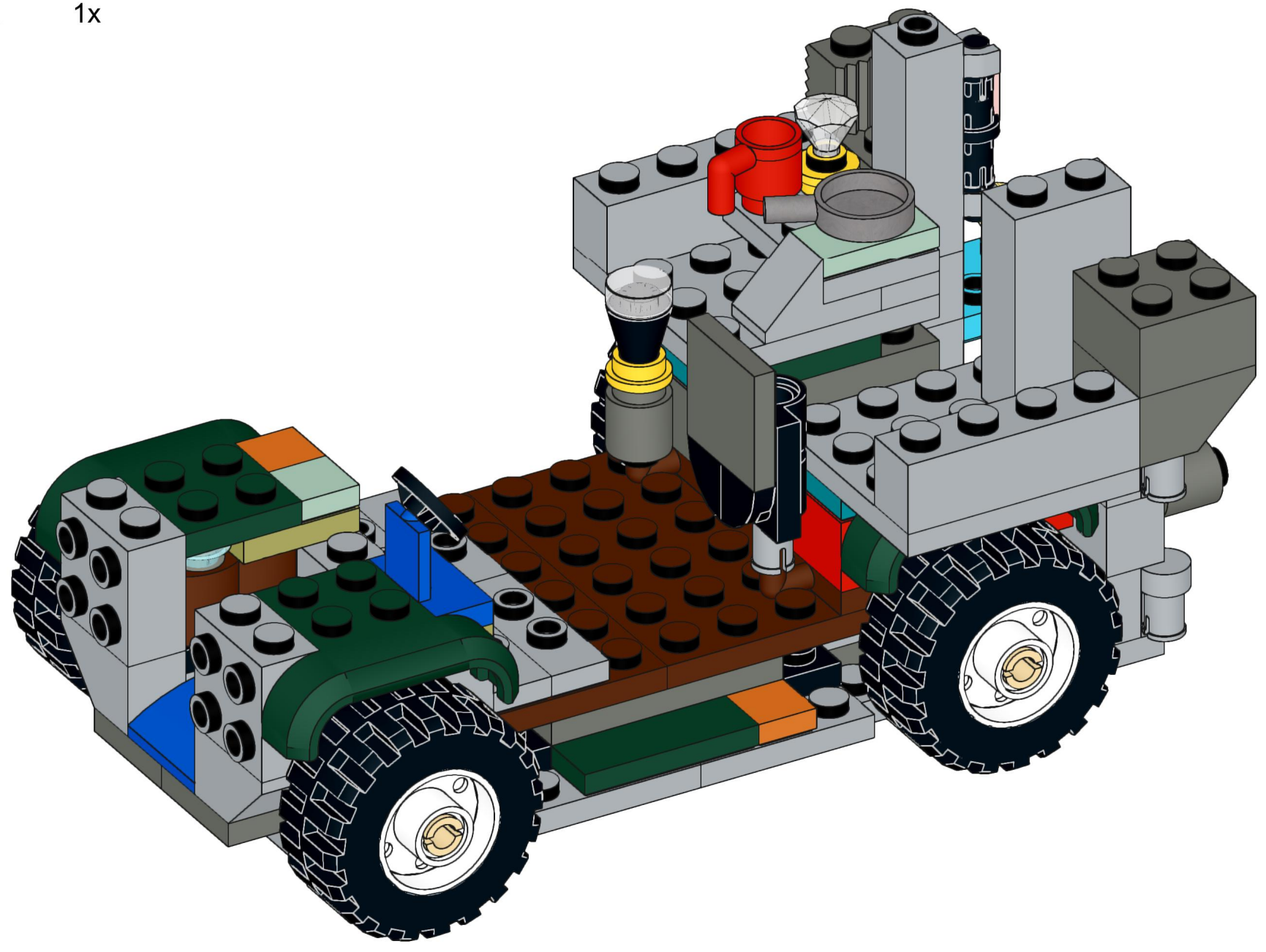

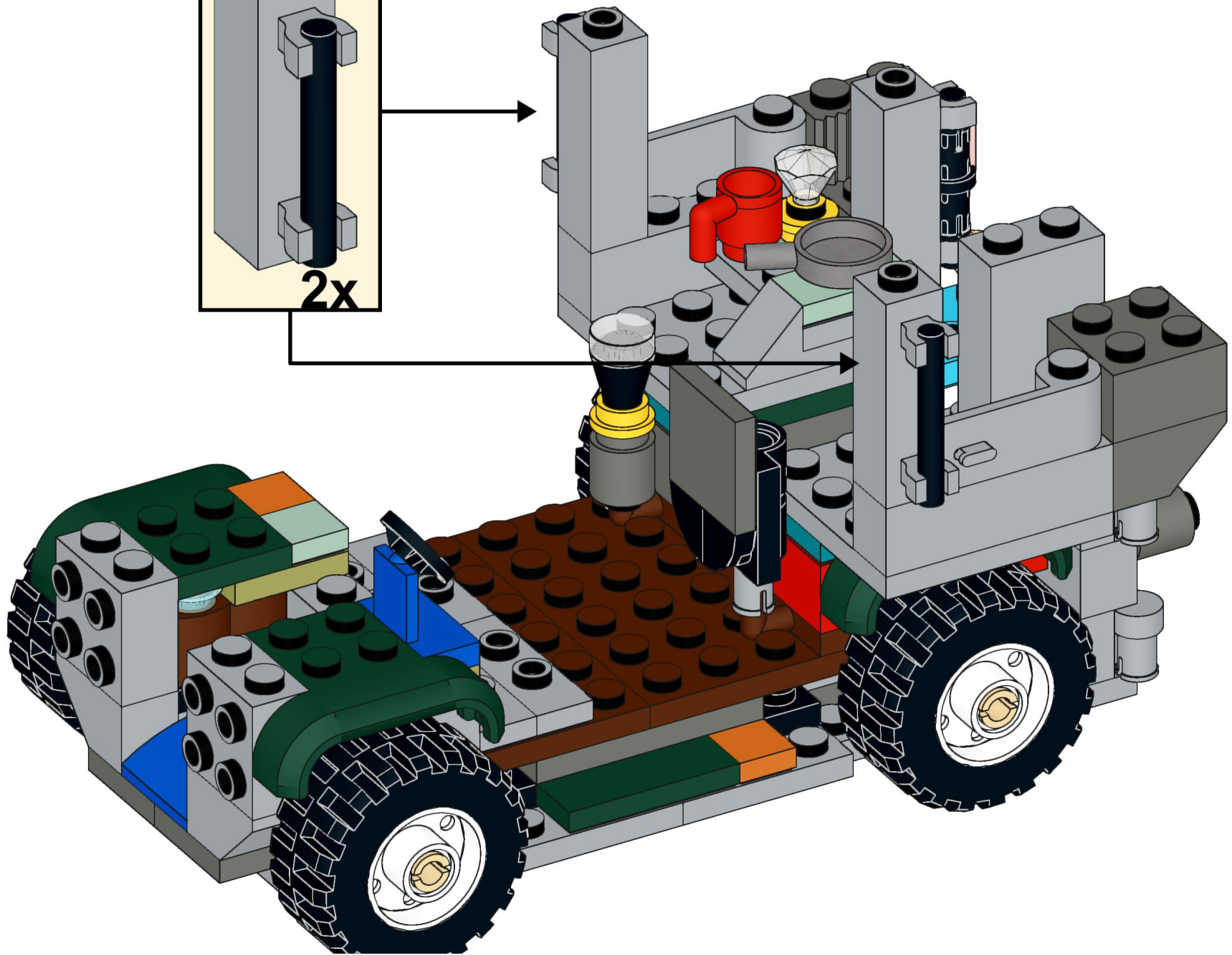
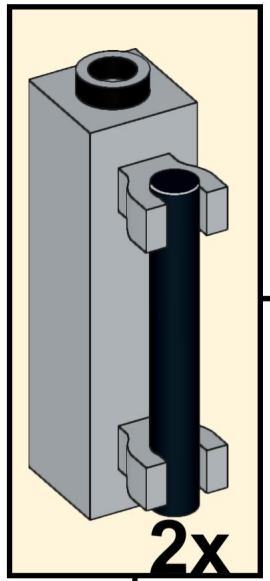
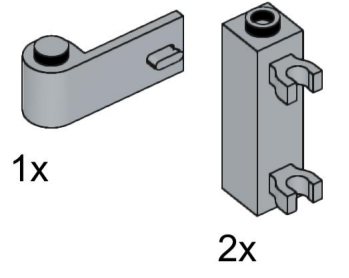
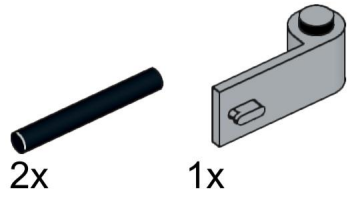

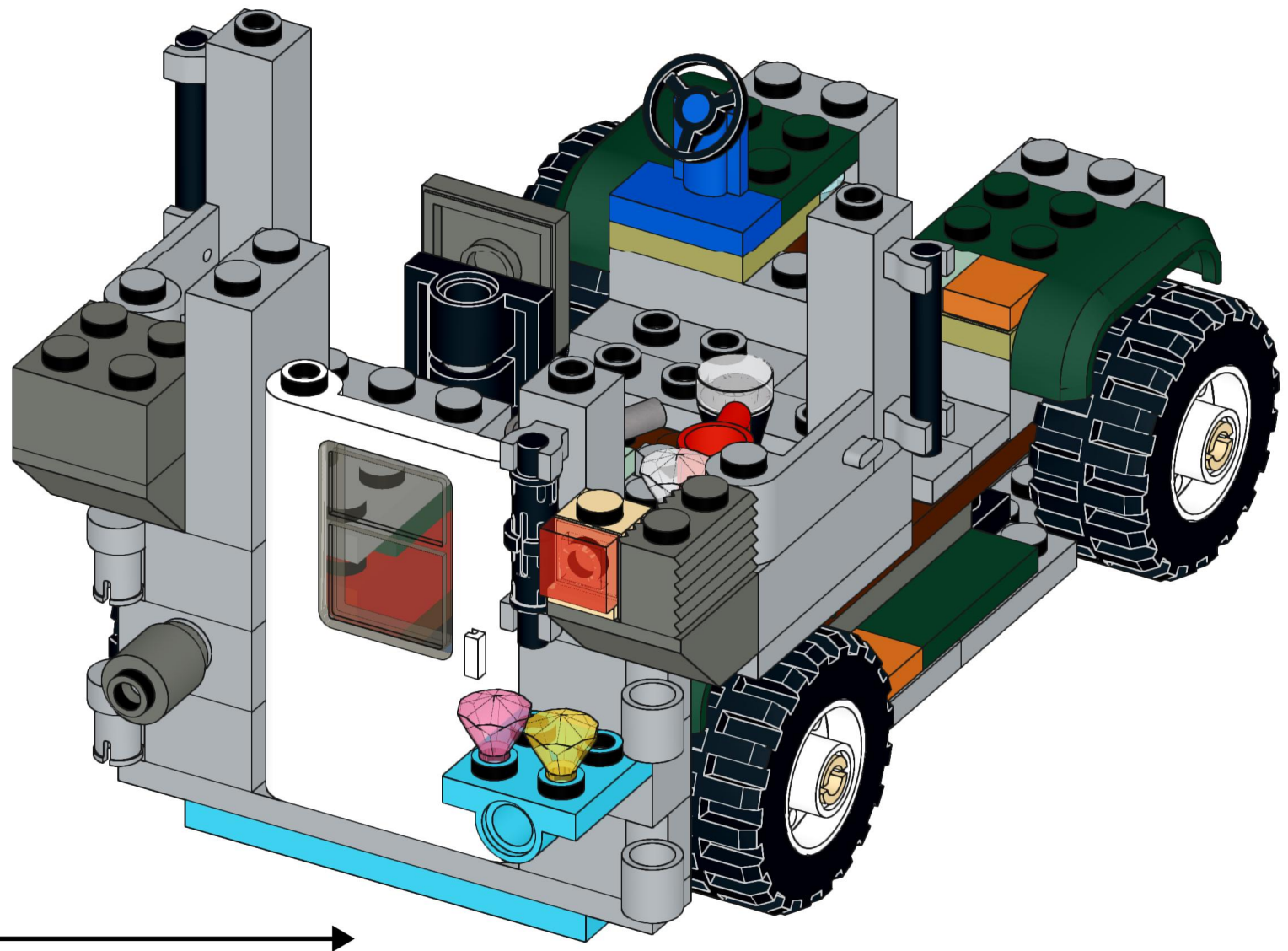
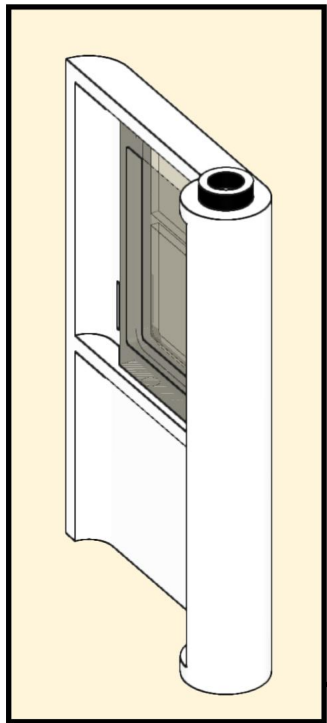
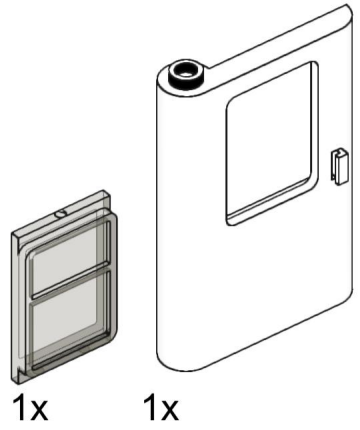

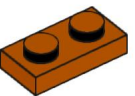
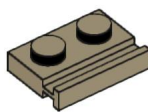
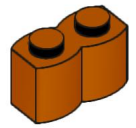
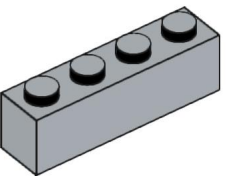
- 1x 
- 1x 
- 1x 
- 1x 

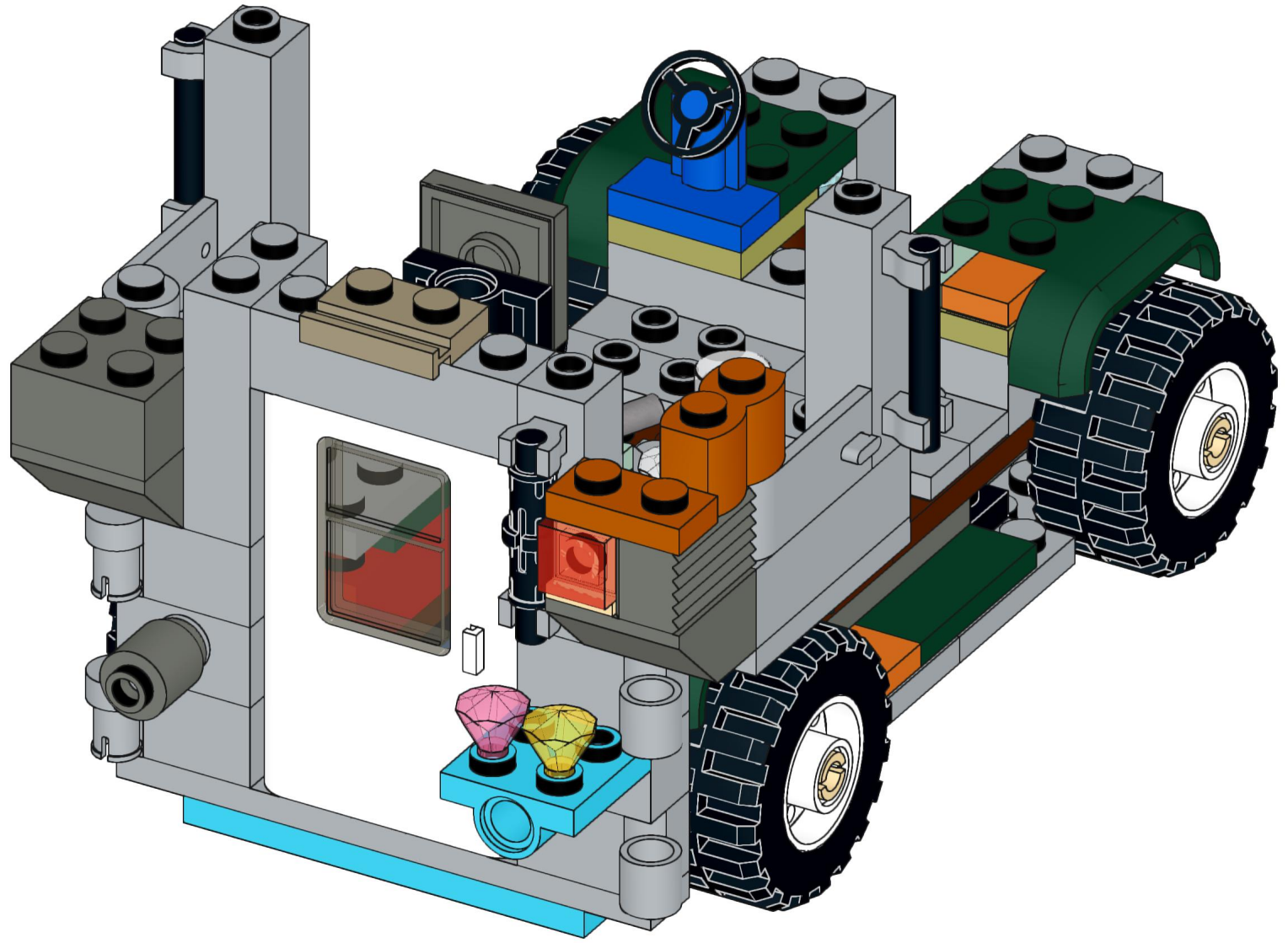

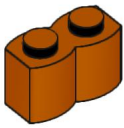
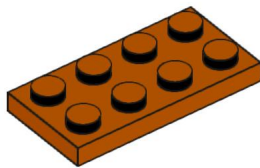
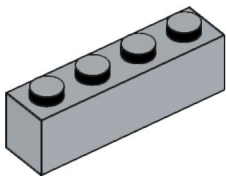
- 1x 
- 1x 
- 1x 

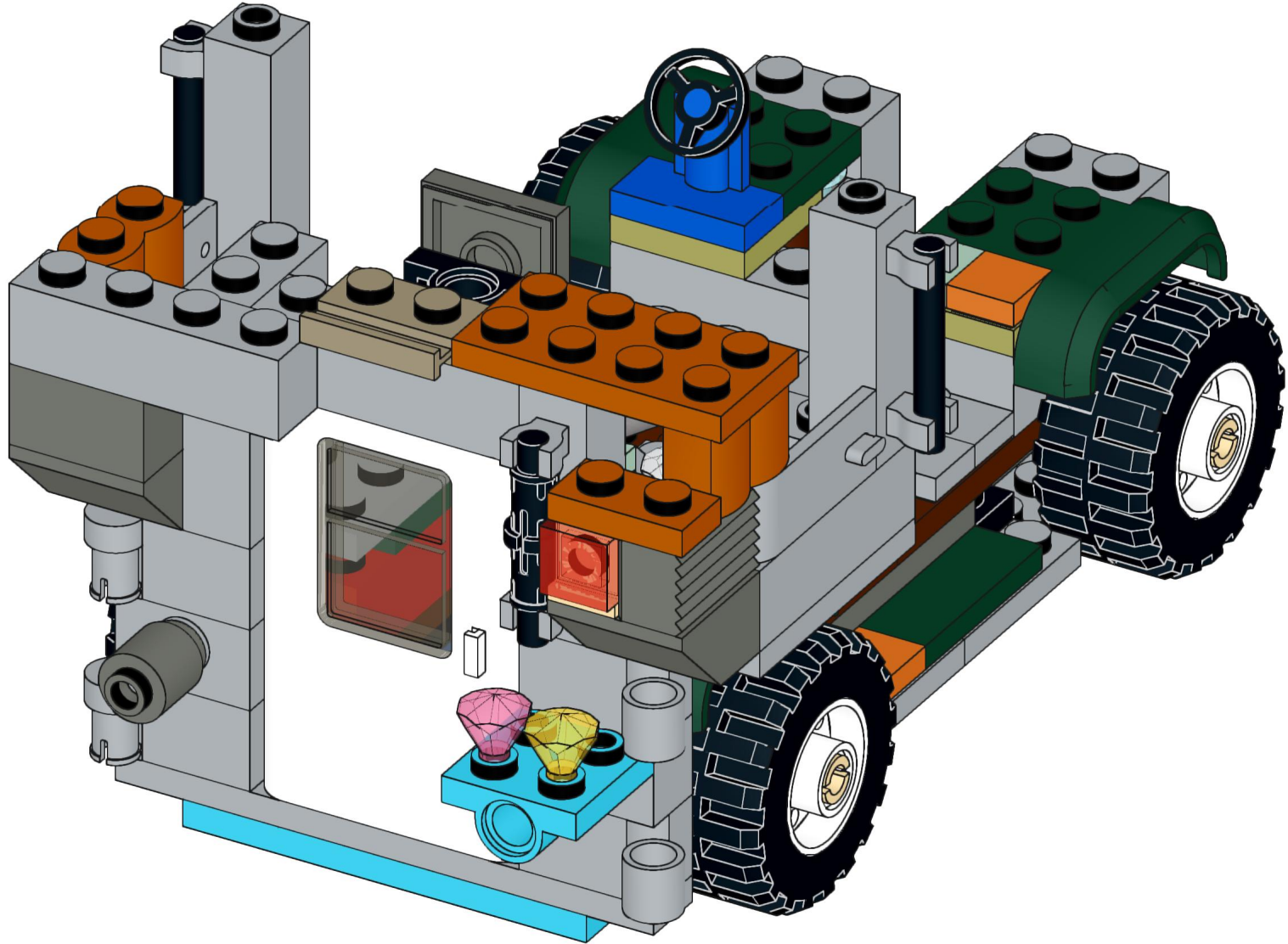

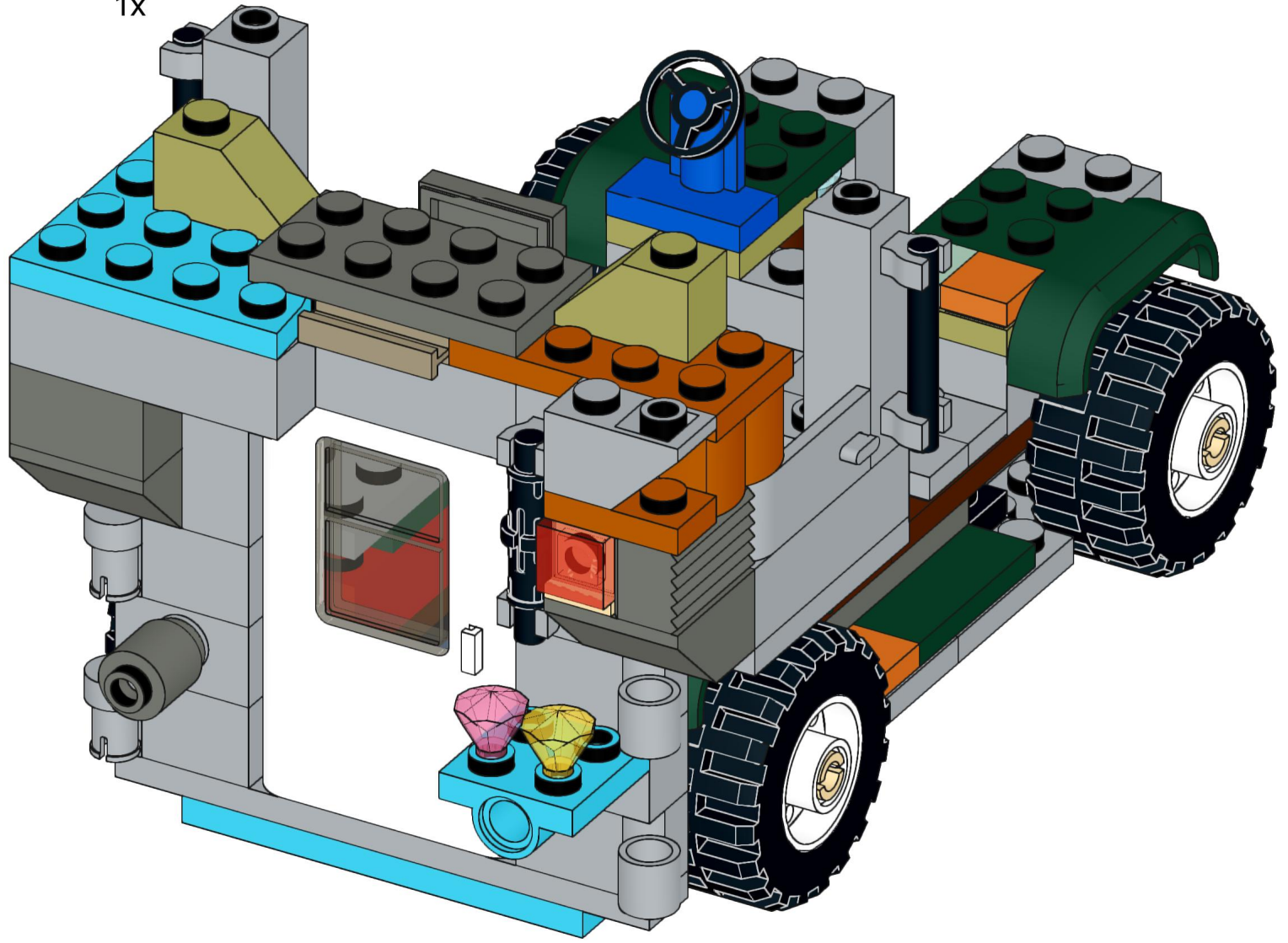
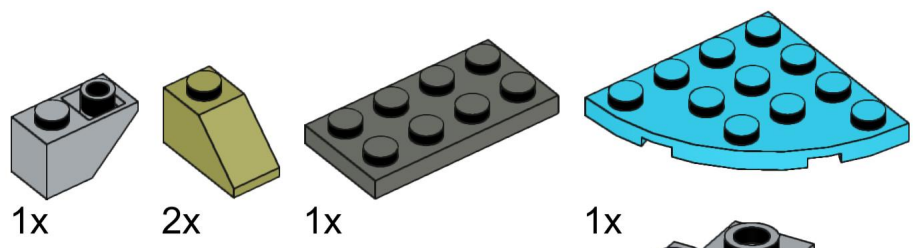

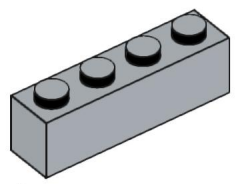

1x

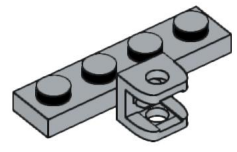

1x

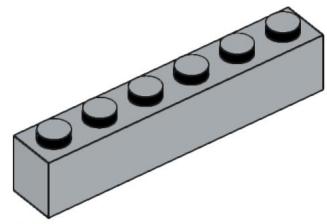

1x

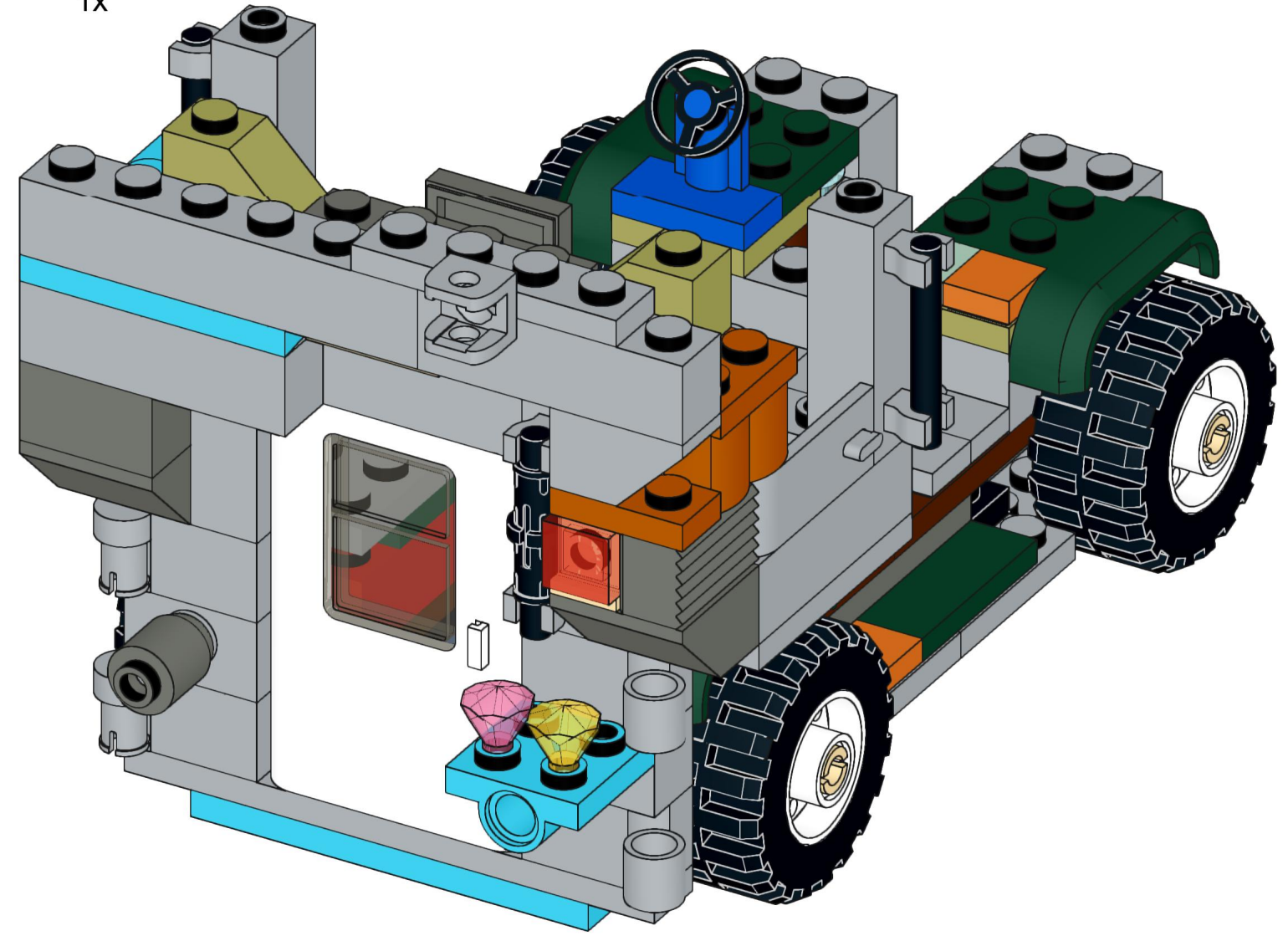

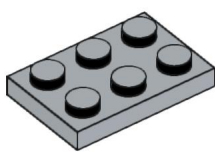
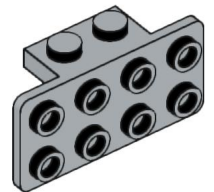
- 1x 
- 1x 
- 1x 

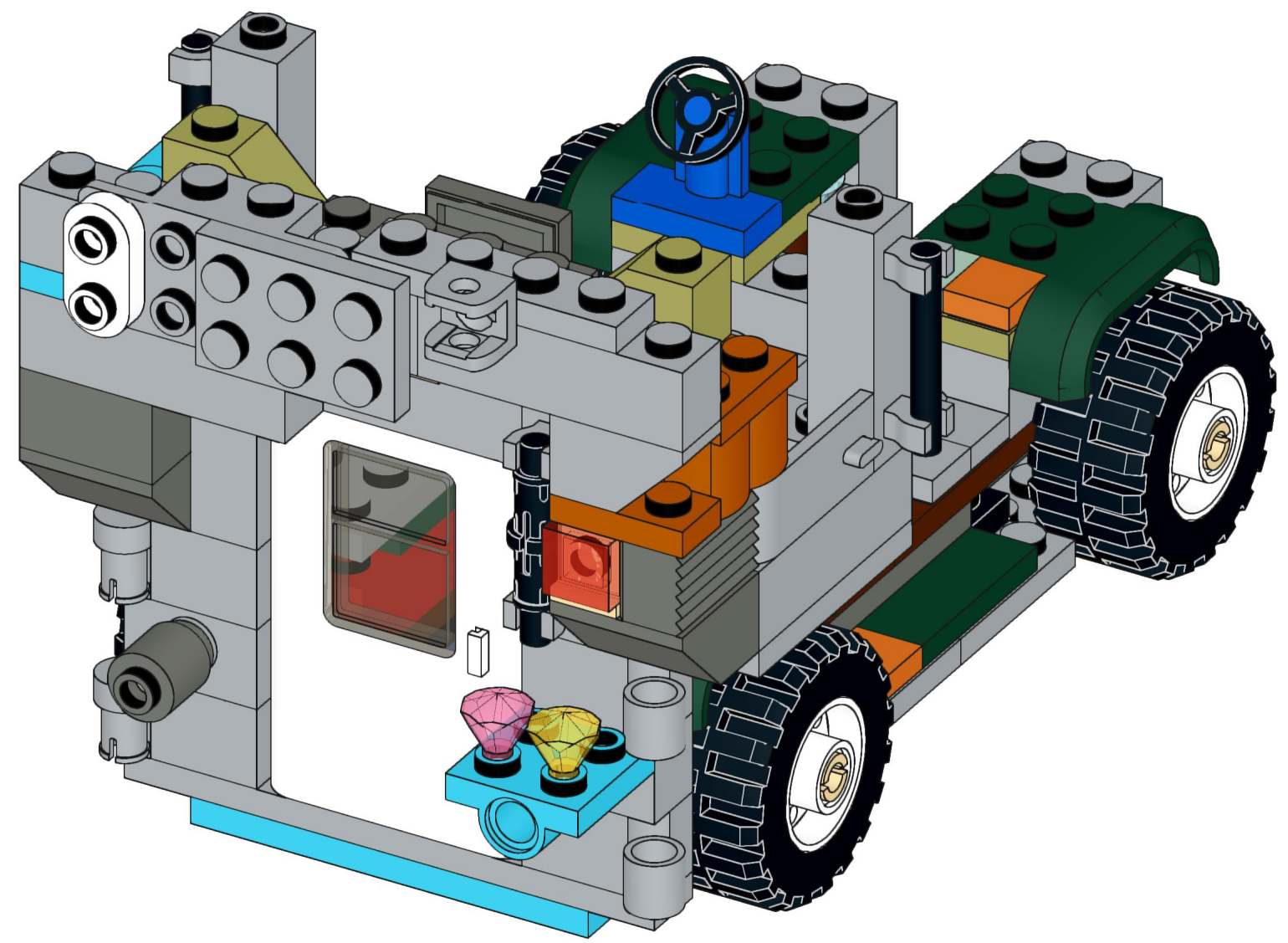

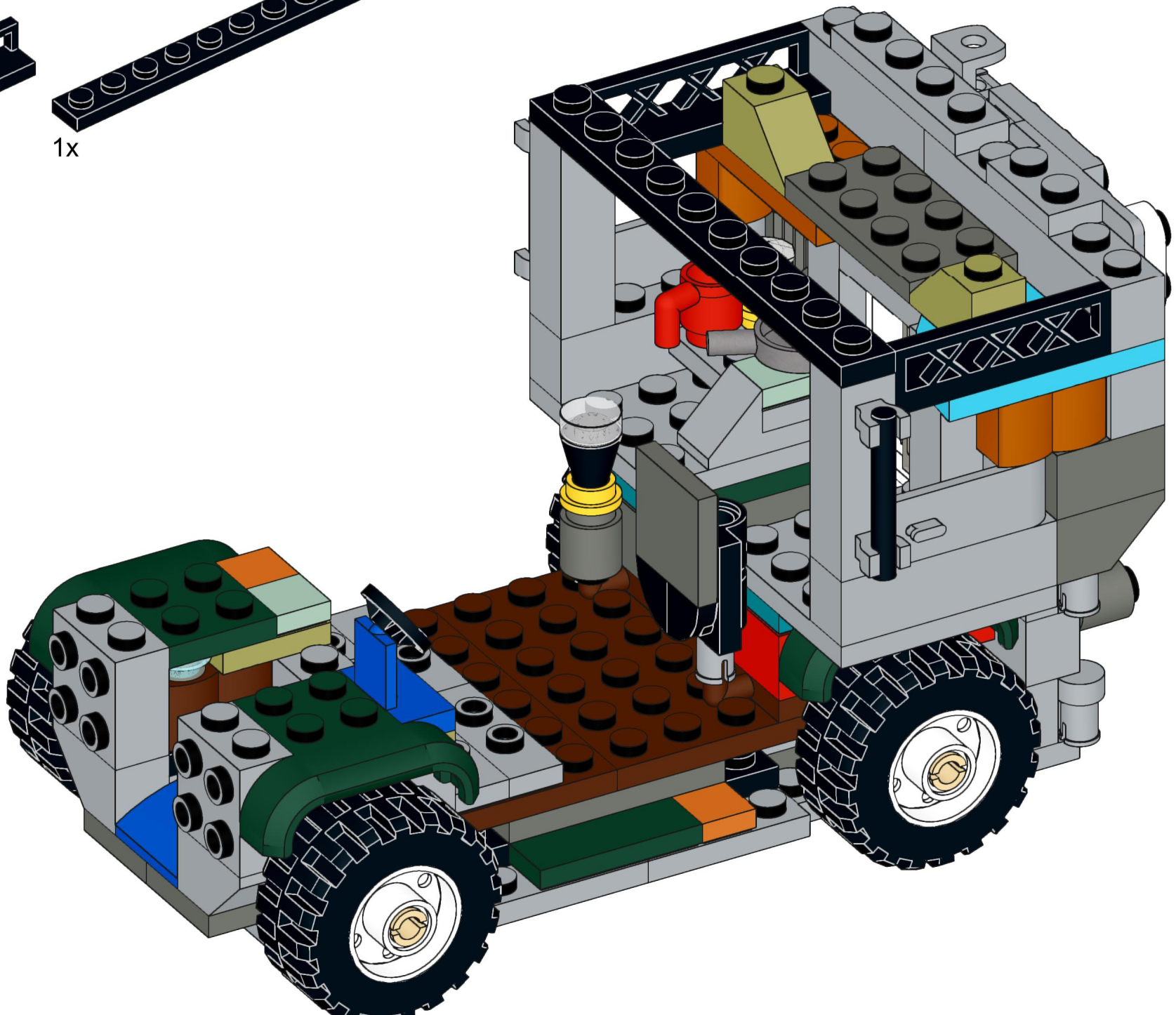
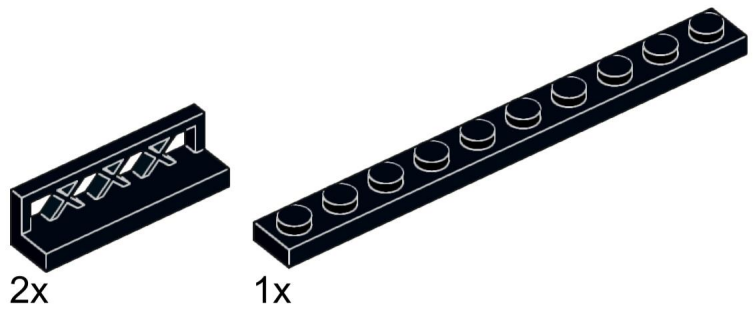

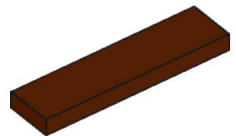

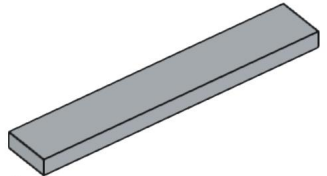

2x

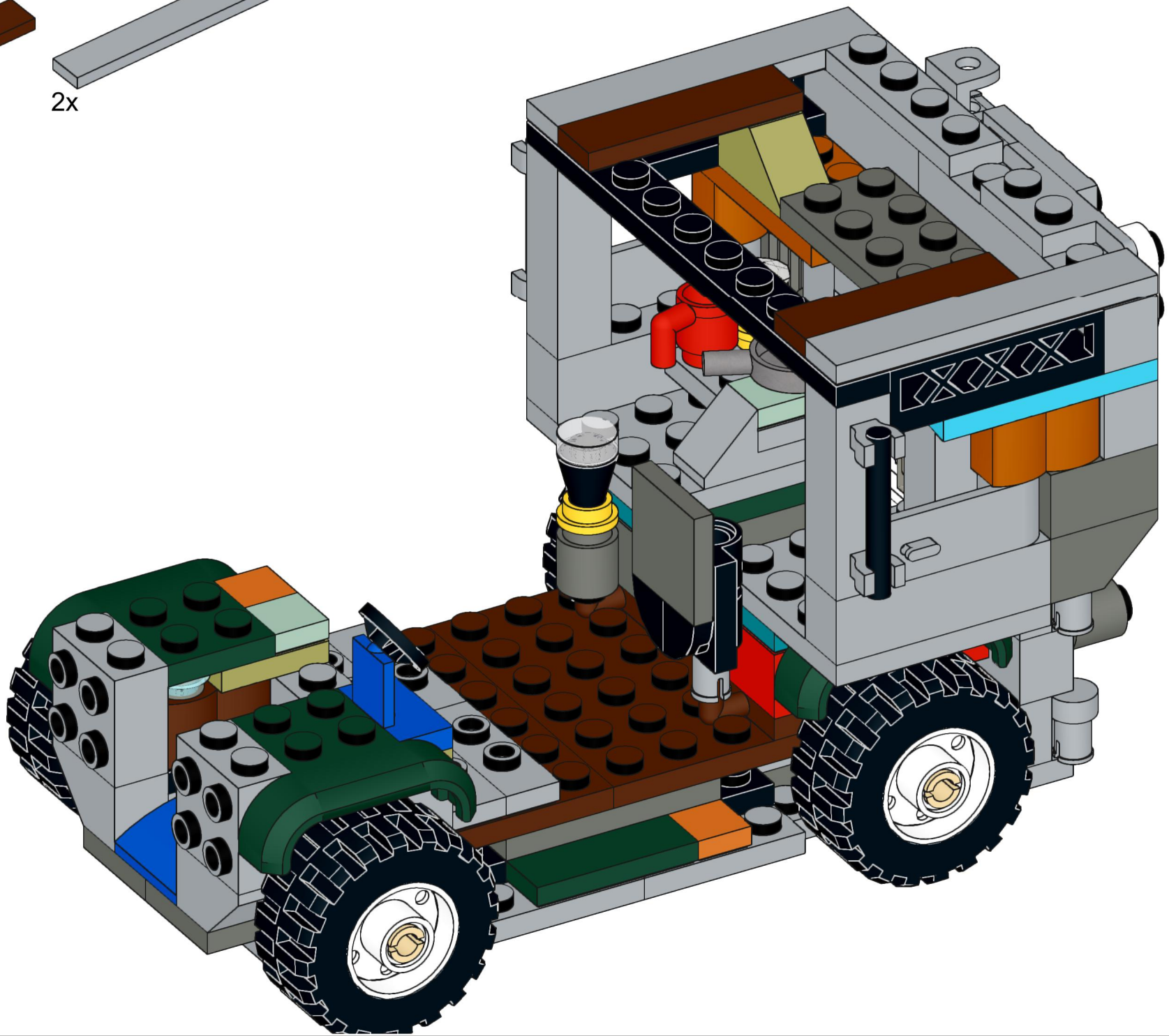

2x

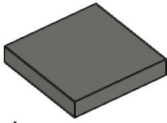
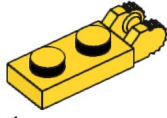
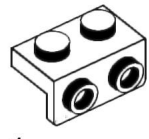

- 1x 
- 1x 
- 1x 
- 1x 

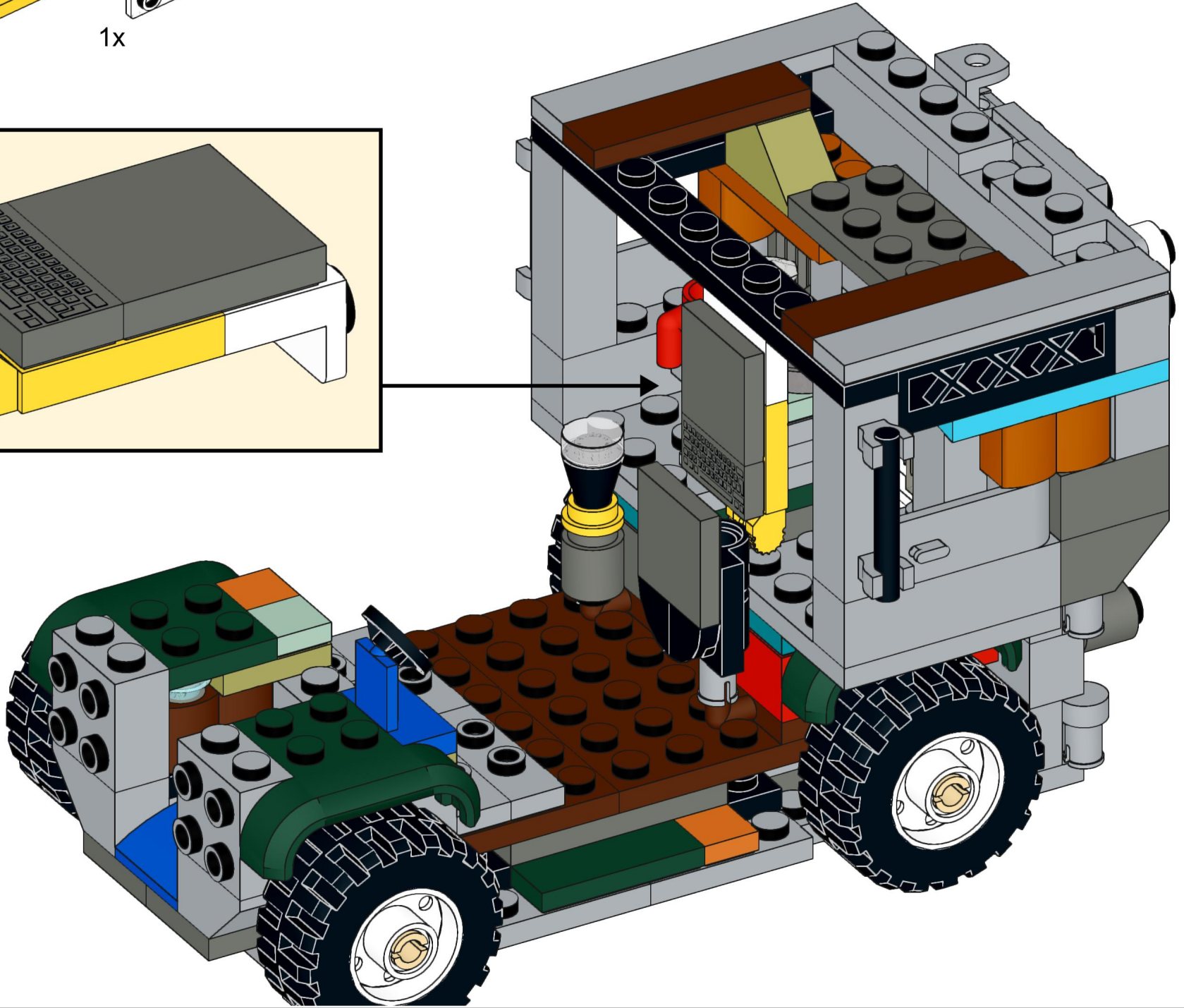
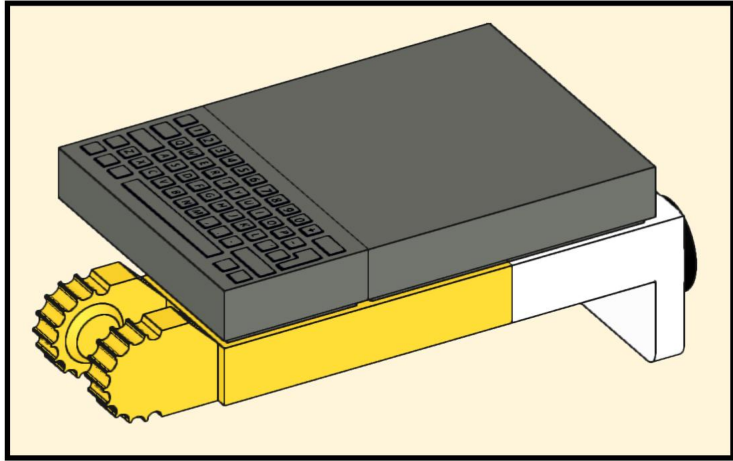

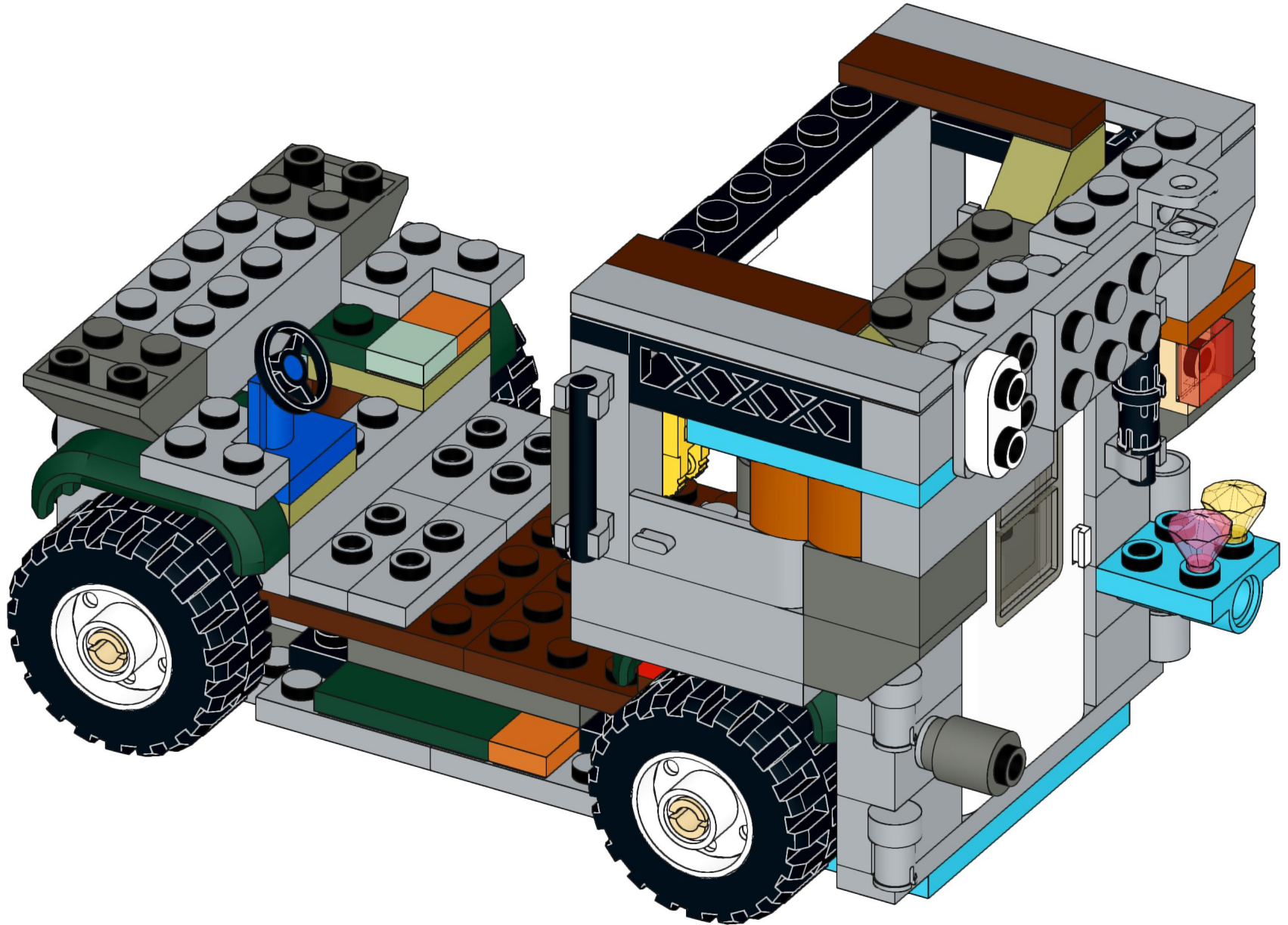
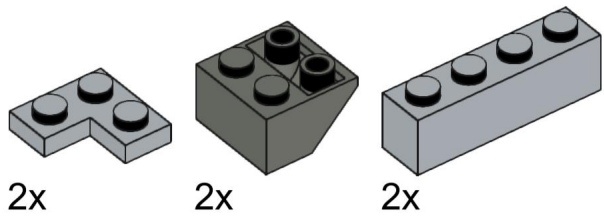

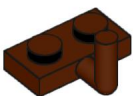
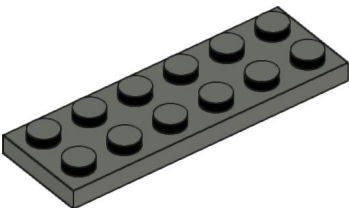
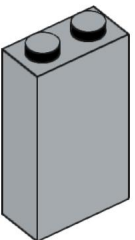
- 2x 
- 1x 
- 2x 

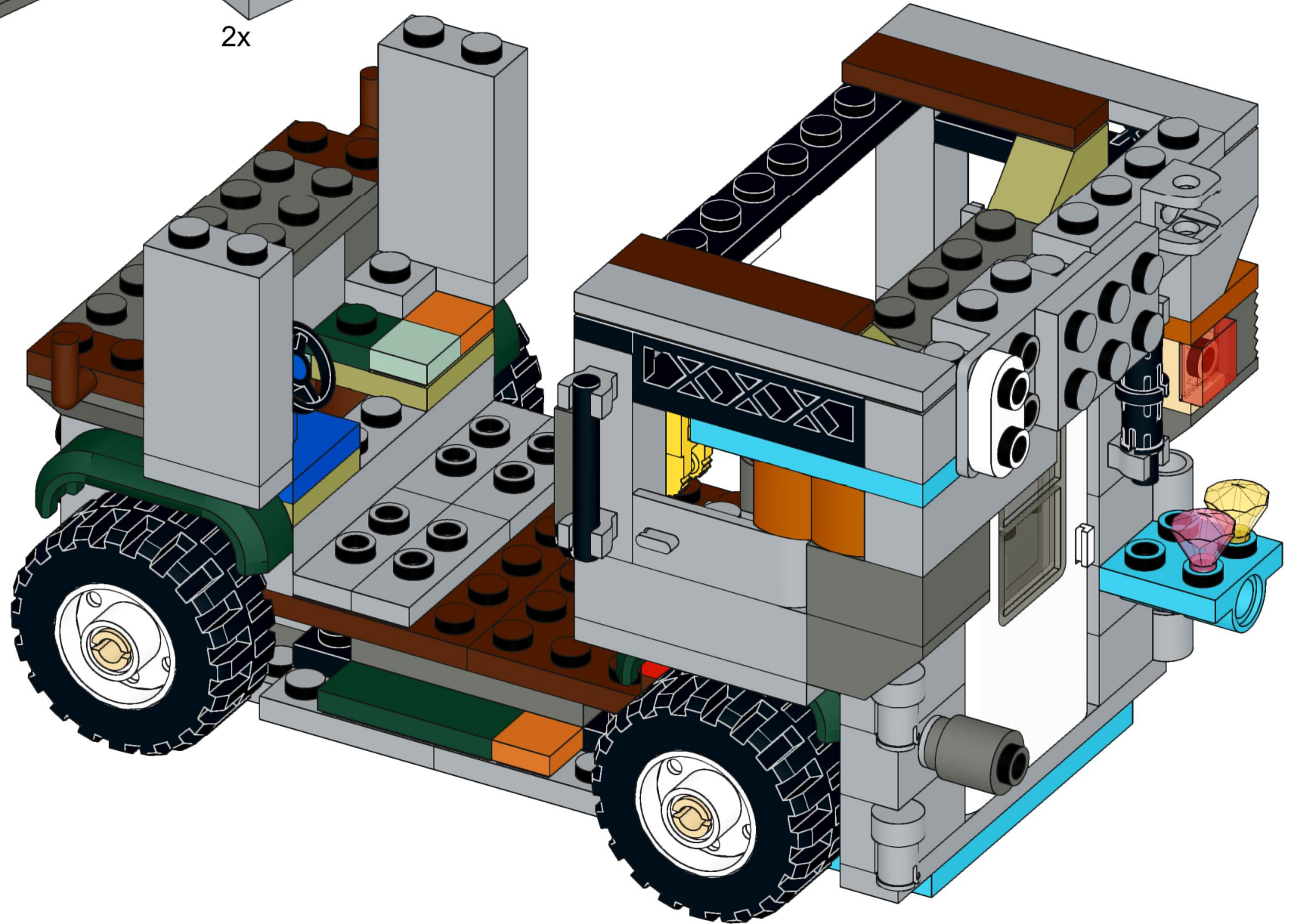

- 1x
- 1x
- 1x
- 1x
- 1x

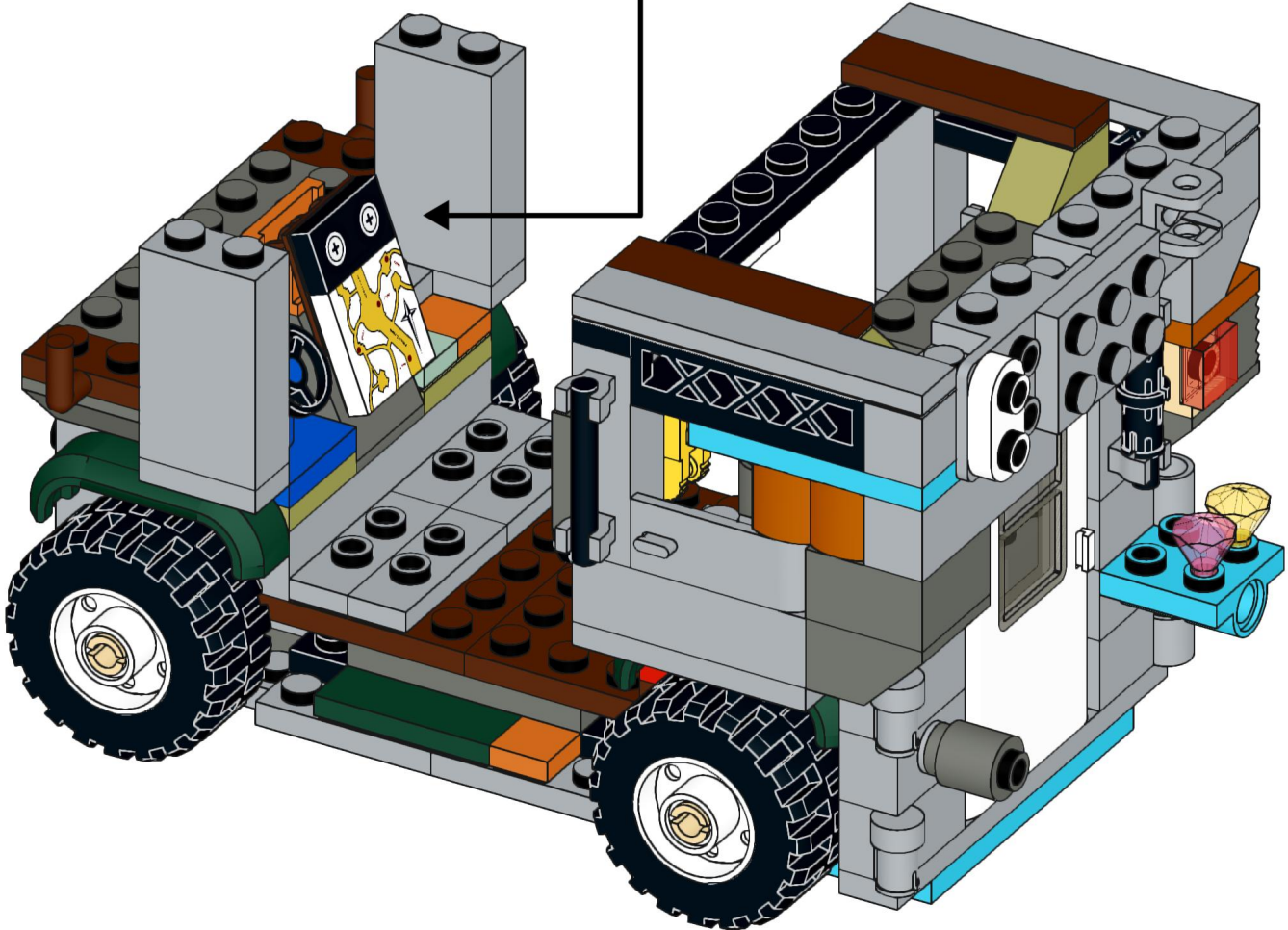
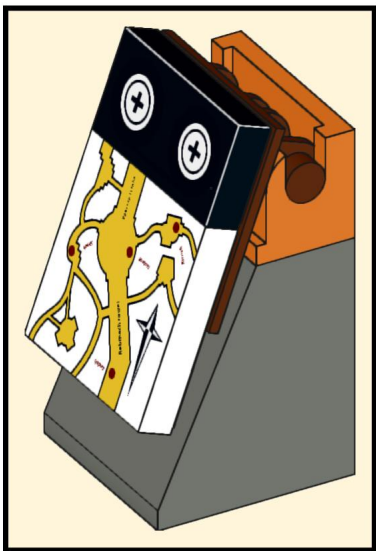

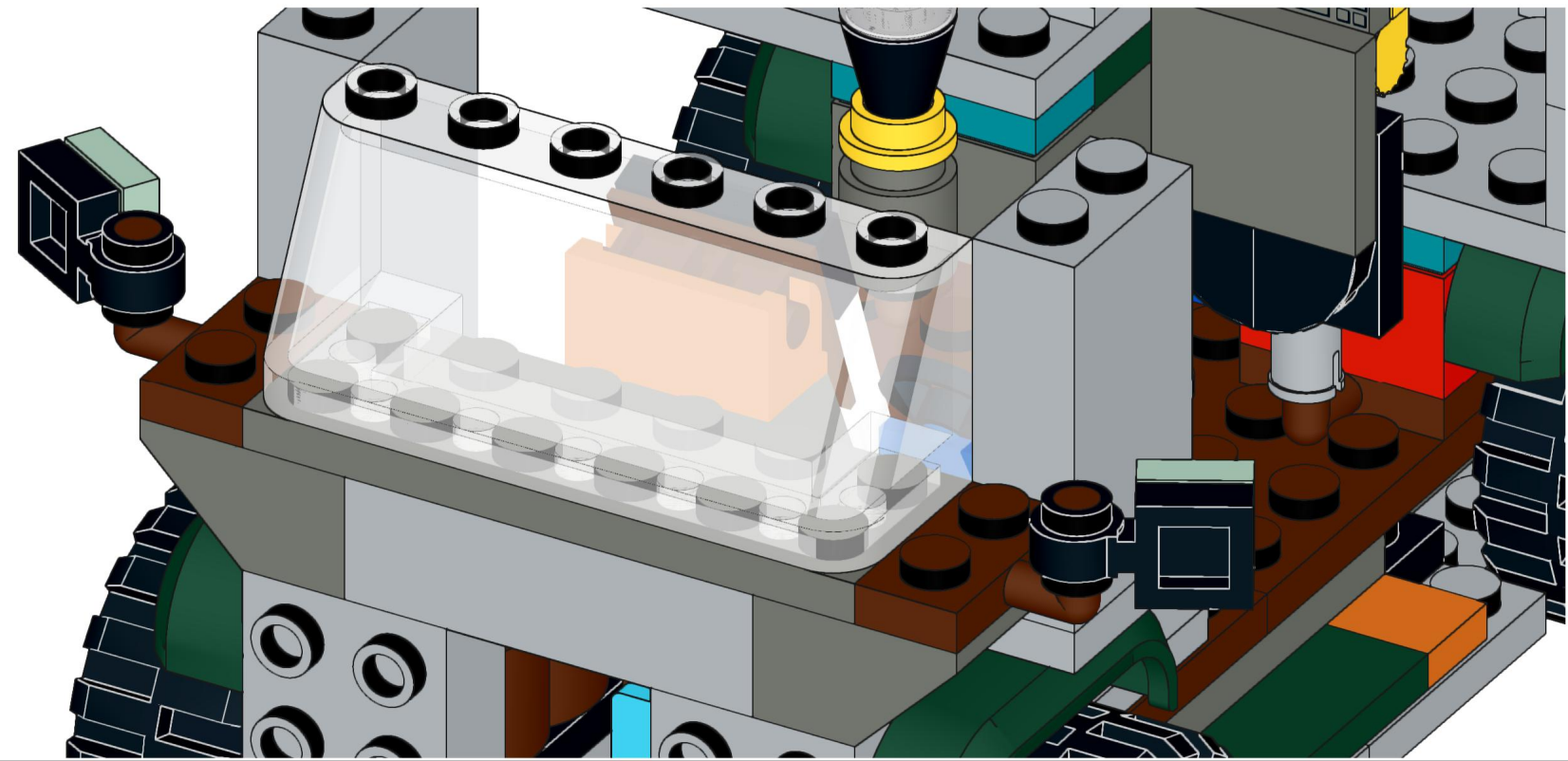
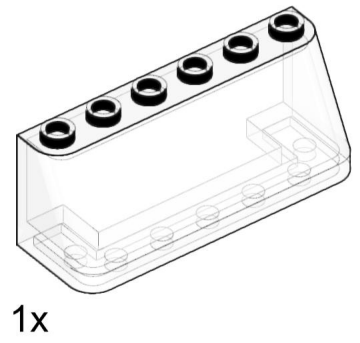
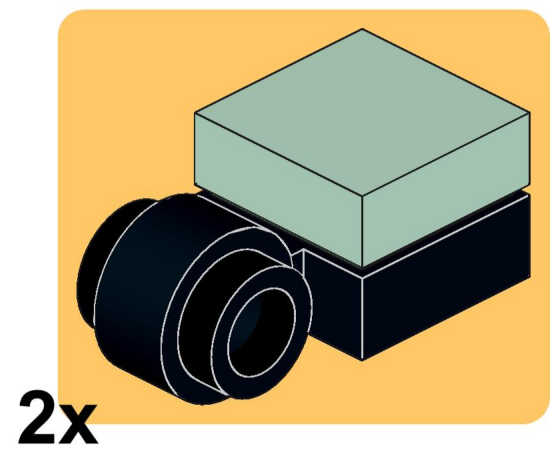
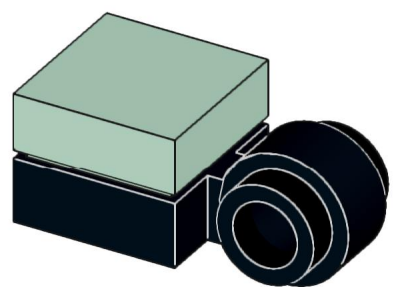
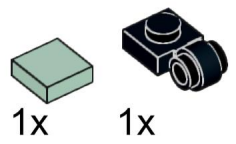

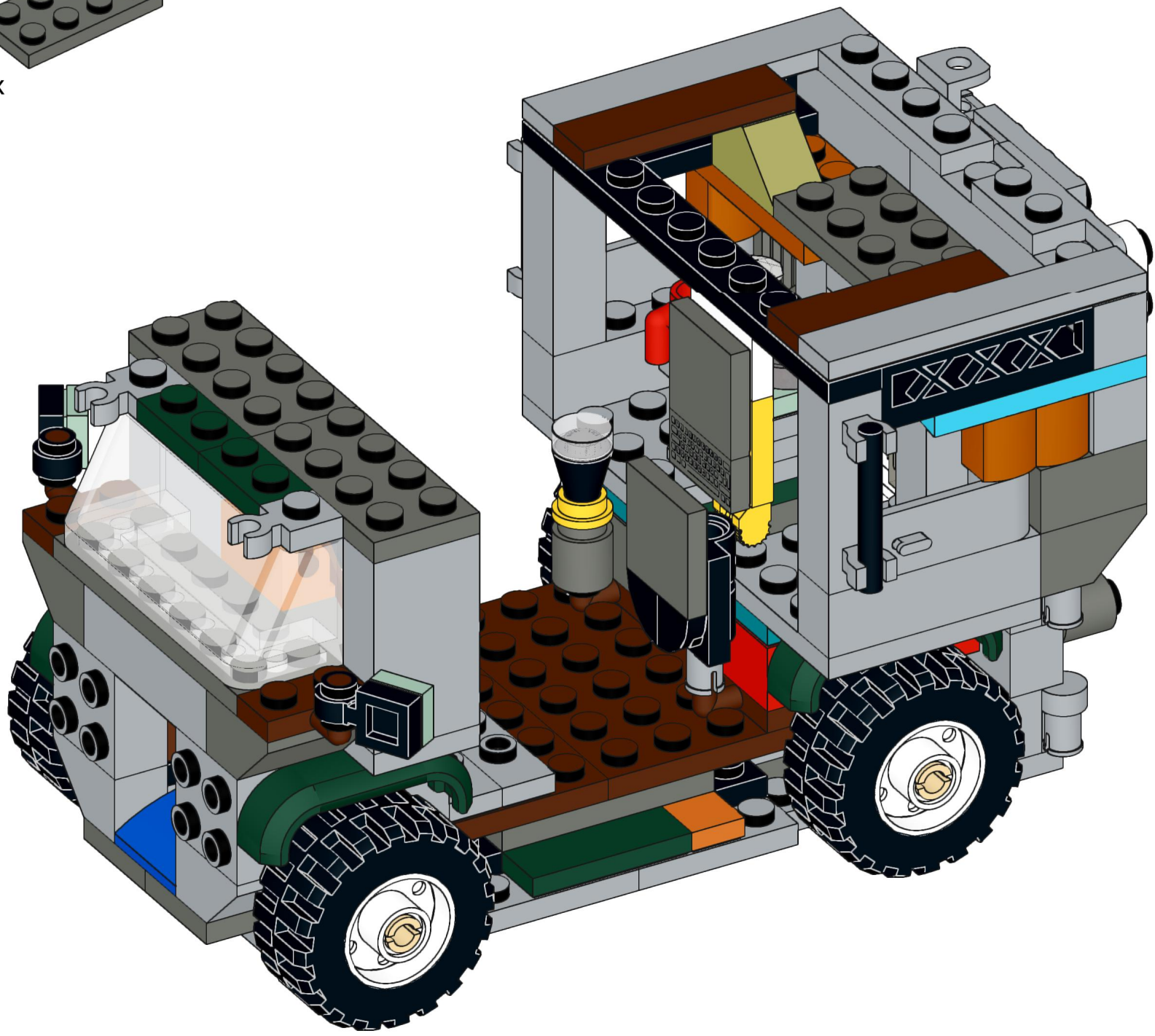
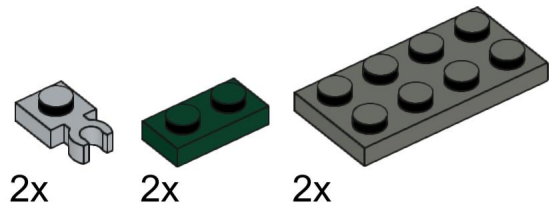

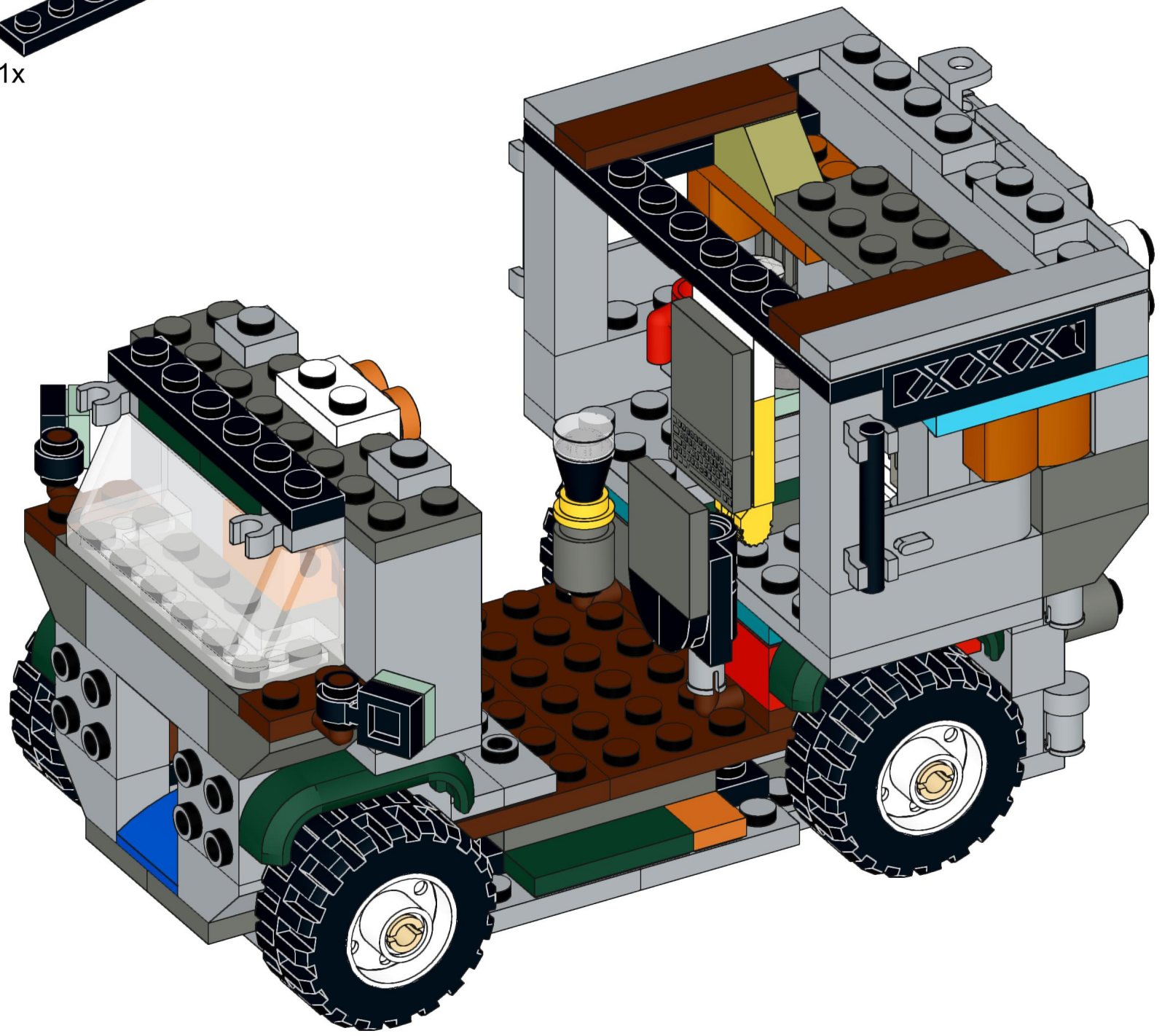

- 2x
- 2x
- 1x
- 1x

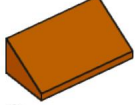

- 4x 
- 2x 
- 2x 

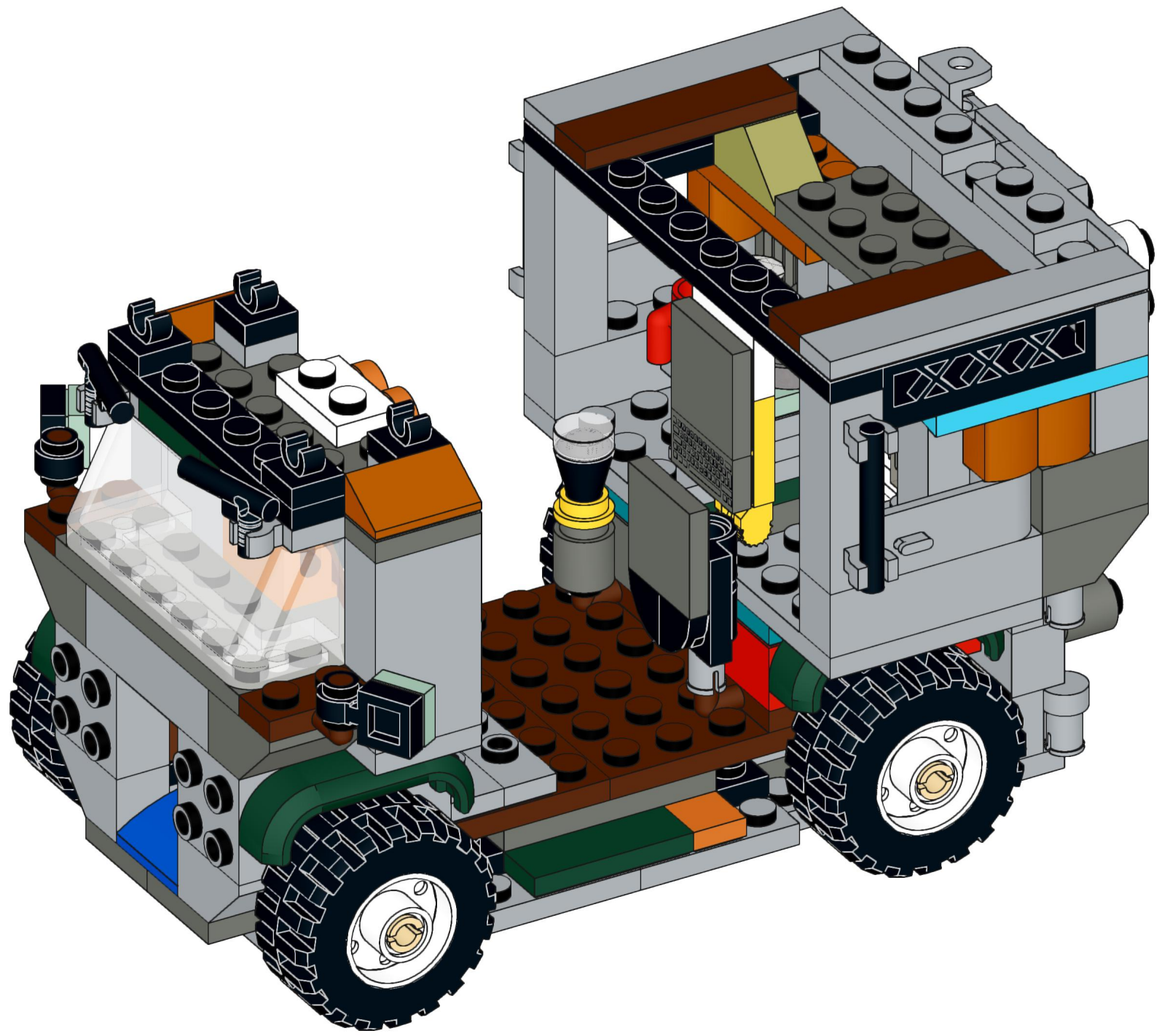

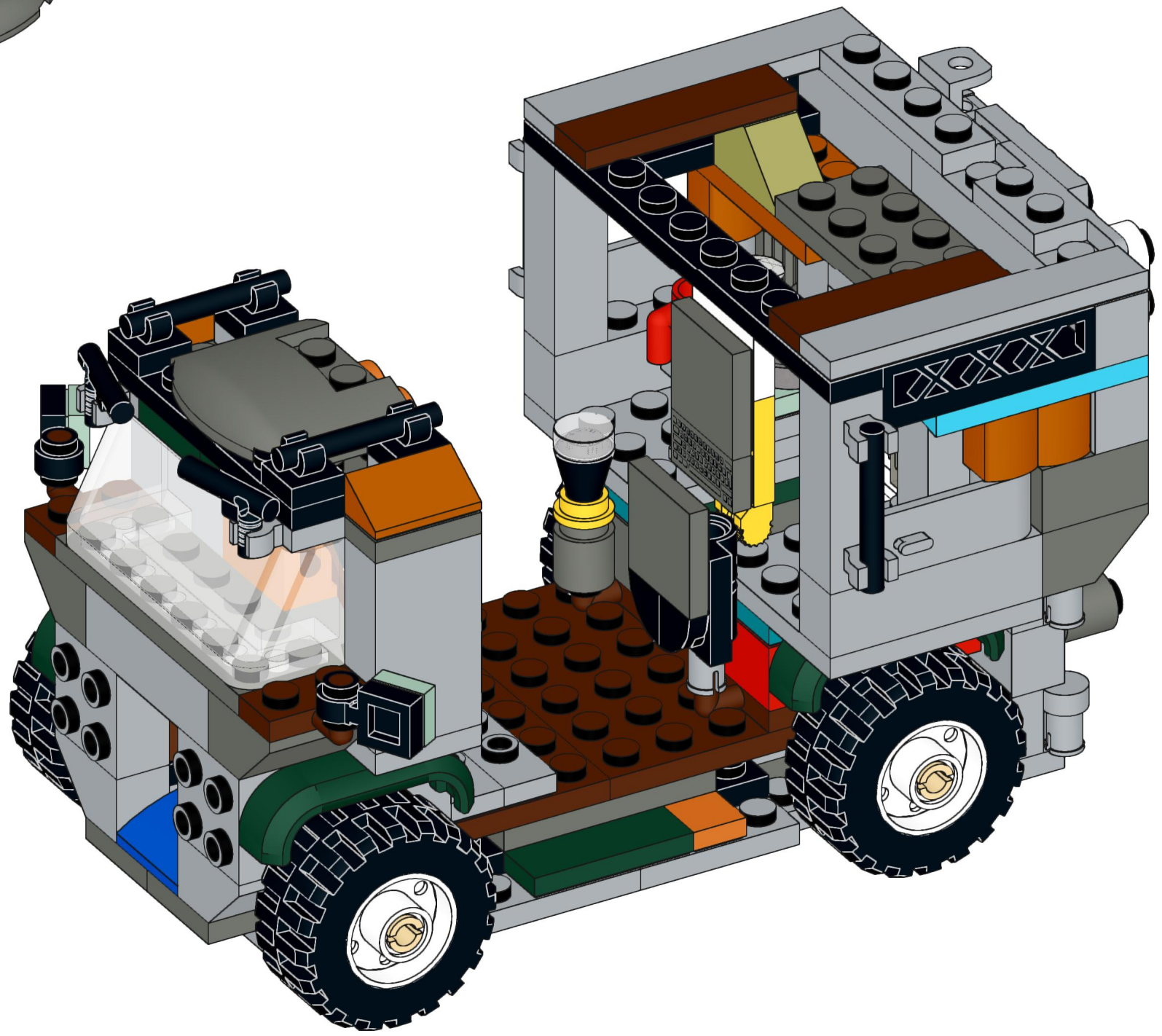
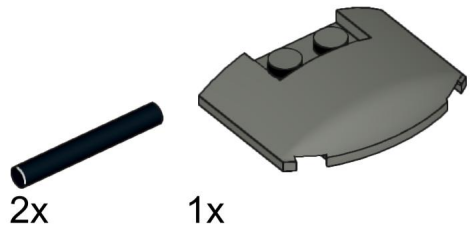

42

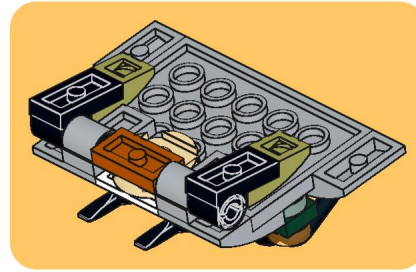
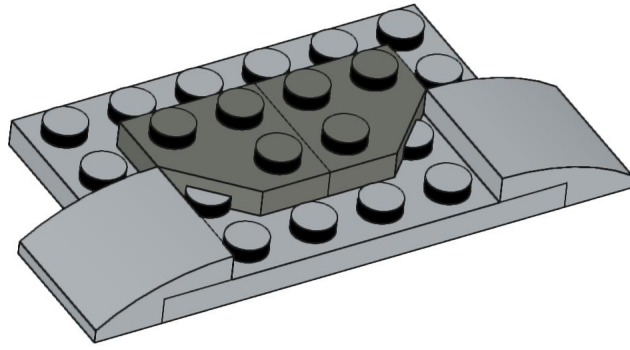
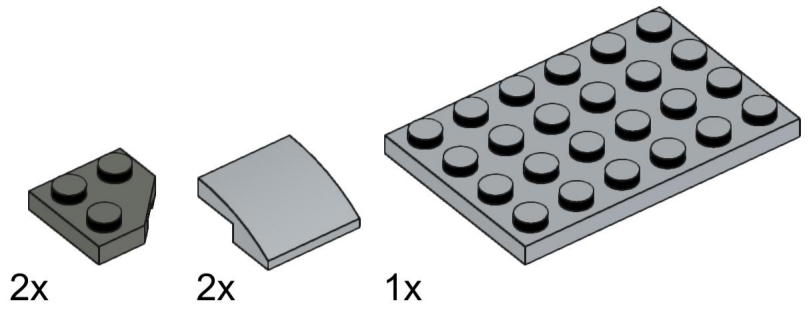

43

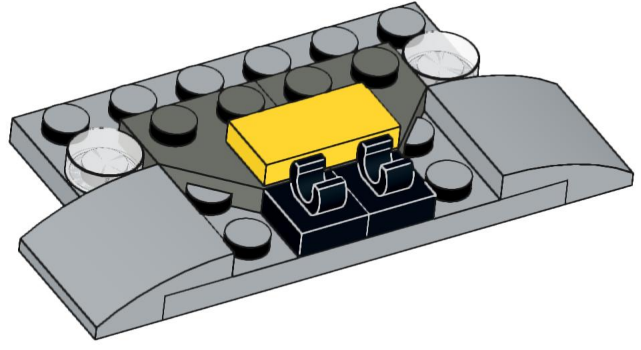
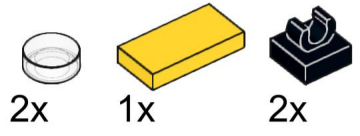

44

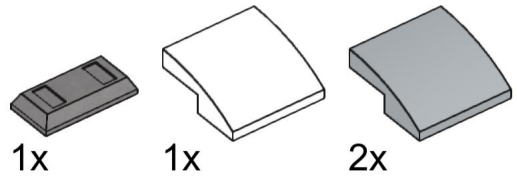

1x

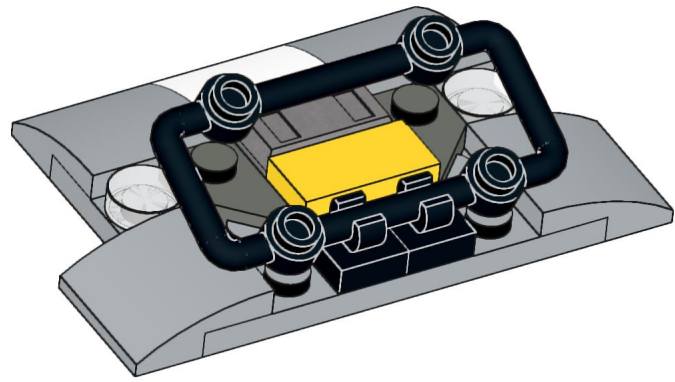

45

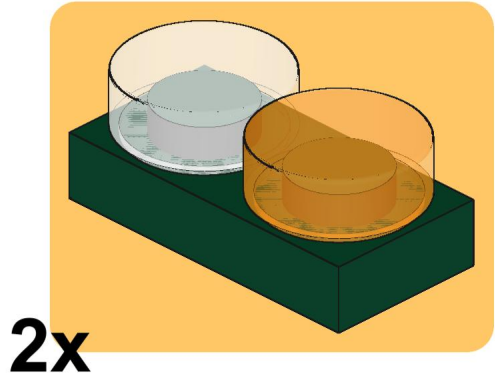
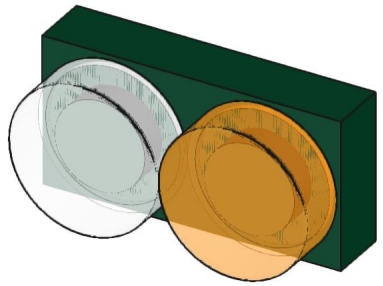
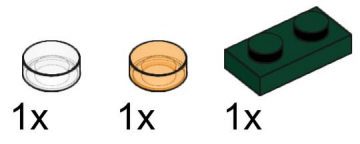

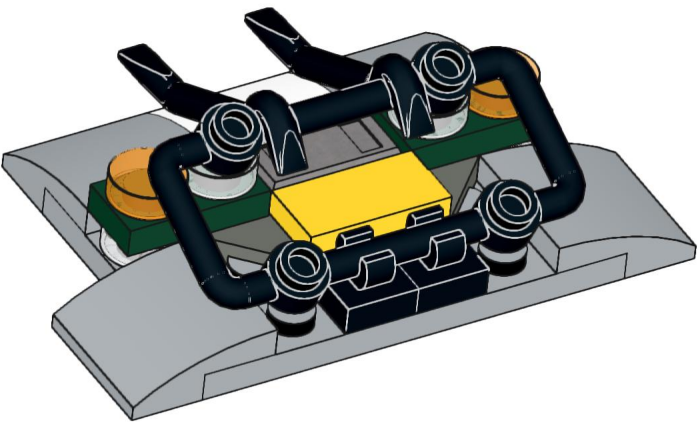

2x

46

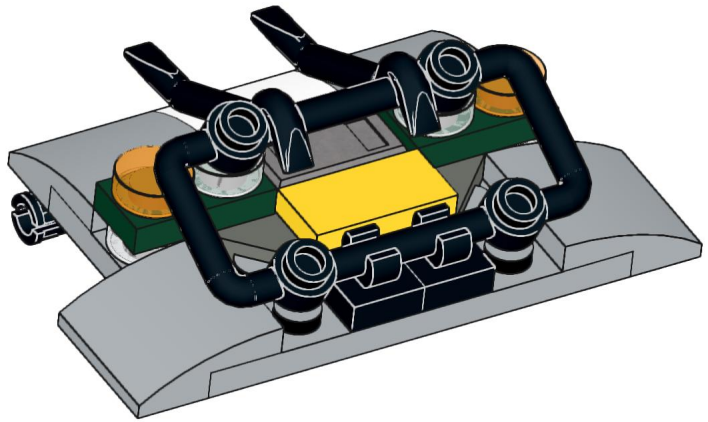
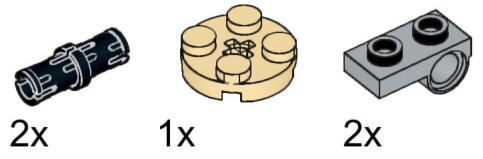

47

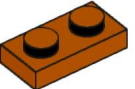

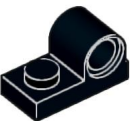
- 1x 
- 2x 
- 2x 

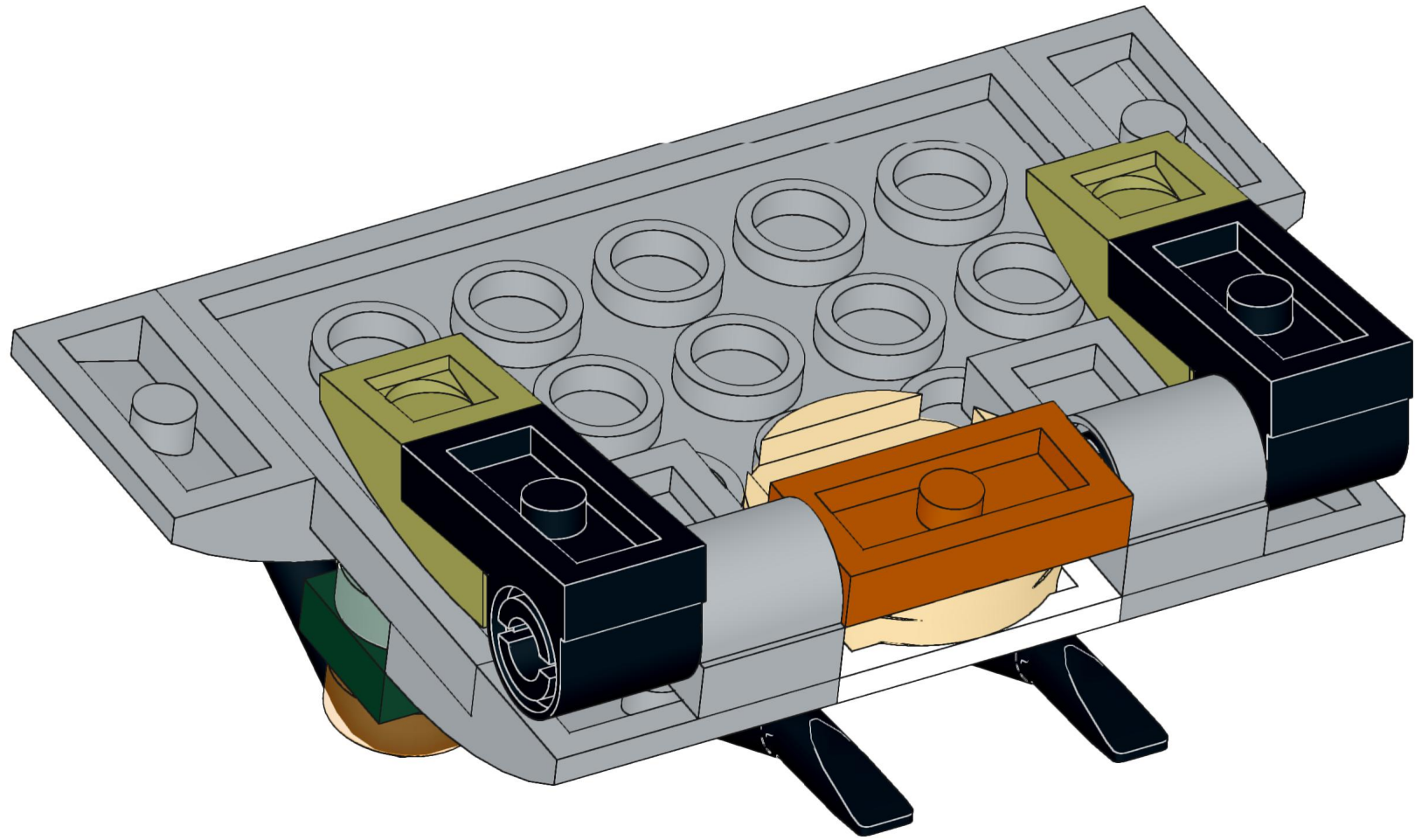

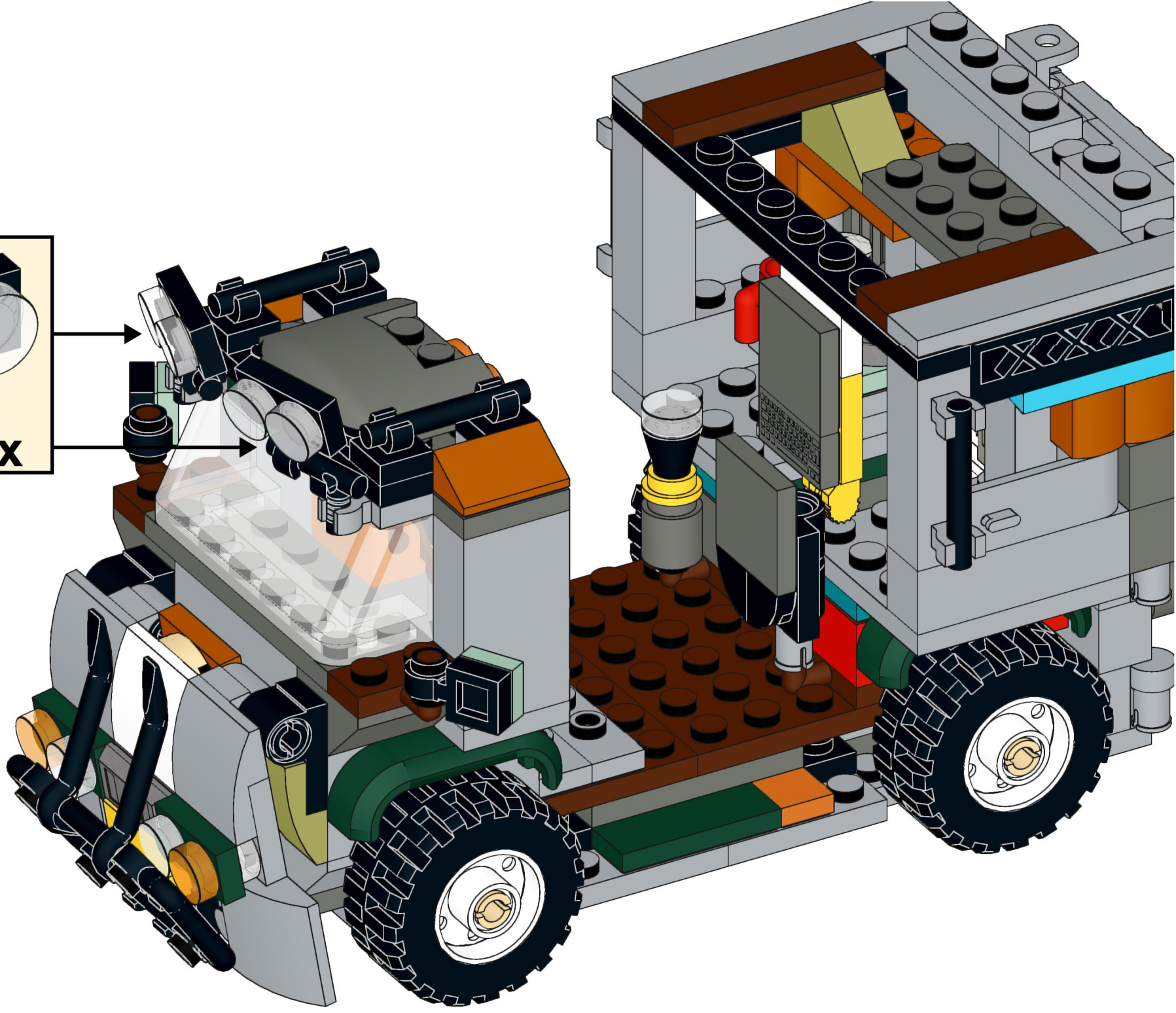
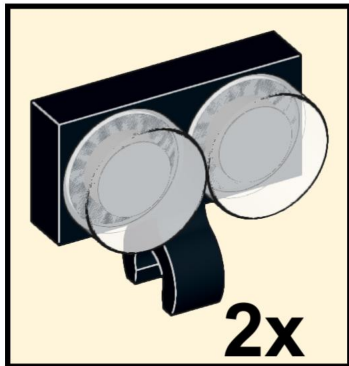
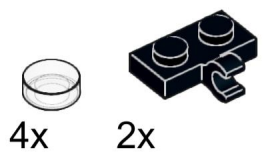

50

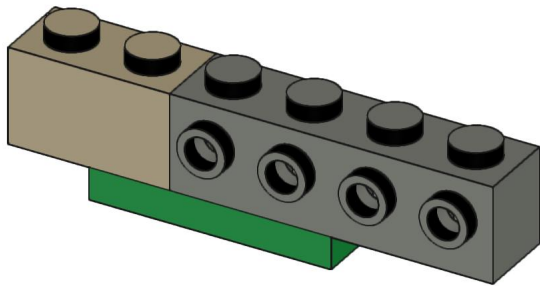
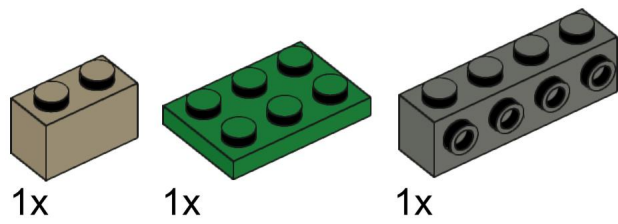

51

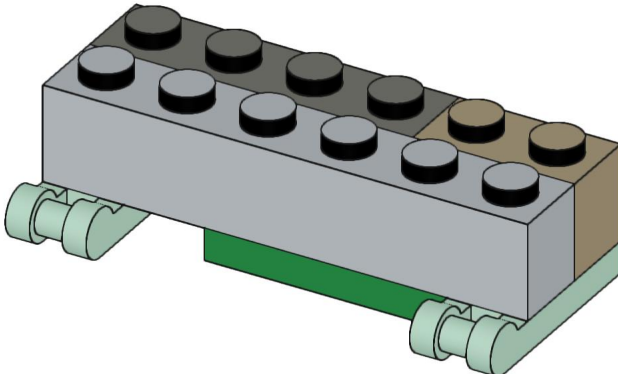
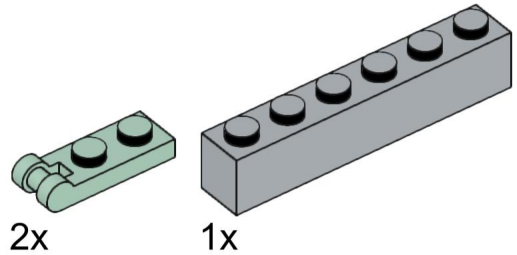

52

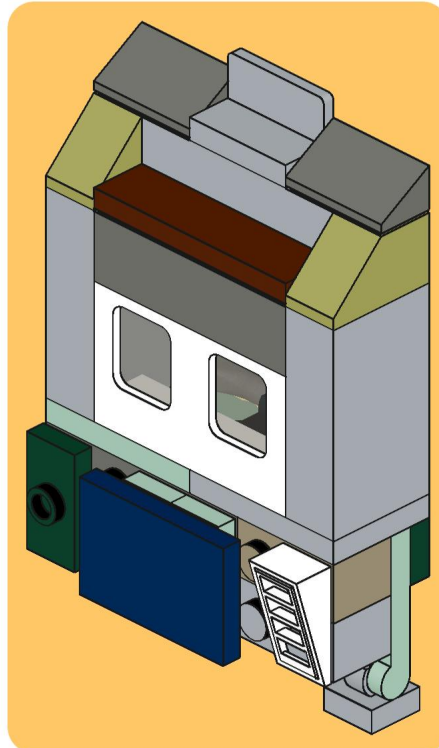
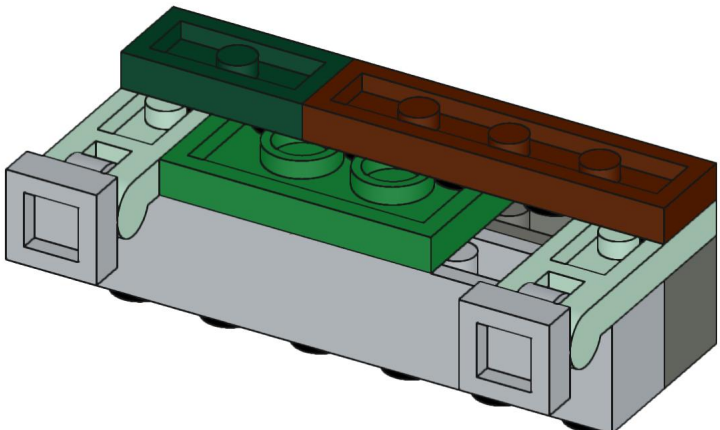
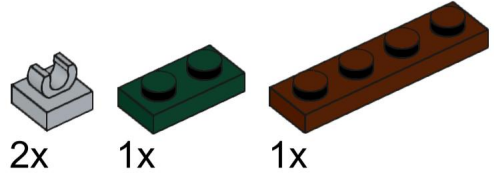

53

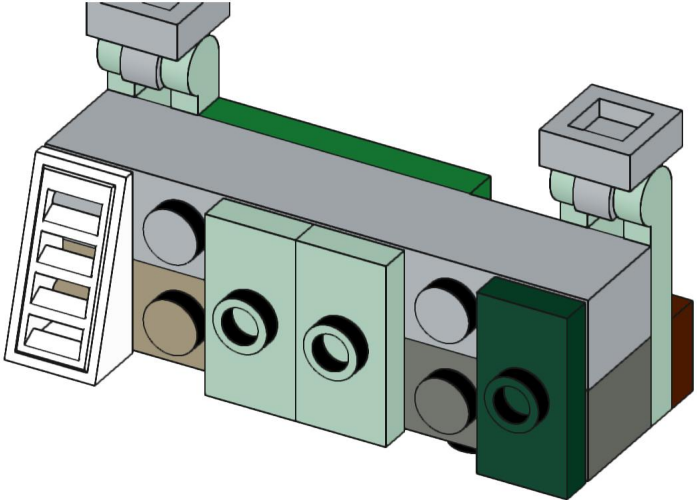
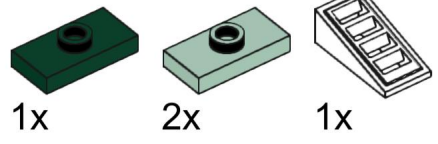

54

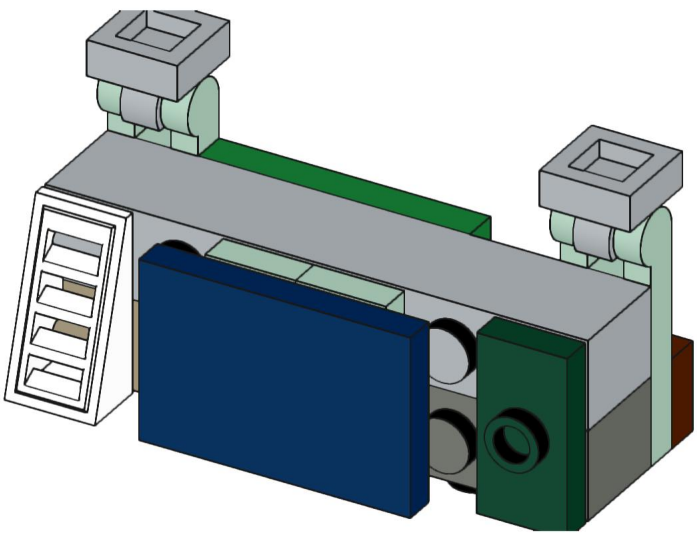
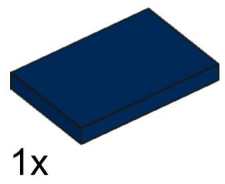

55

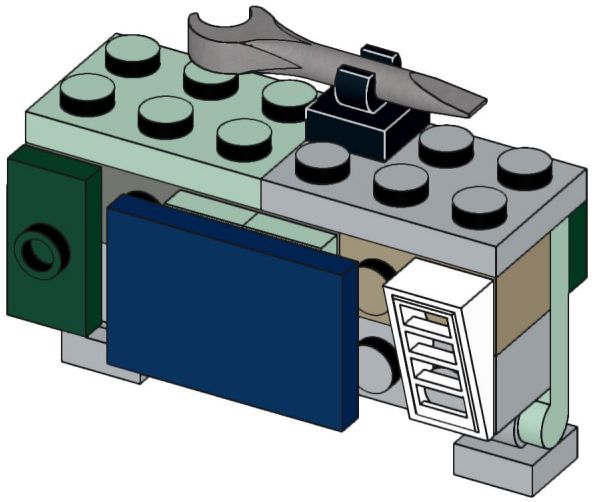
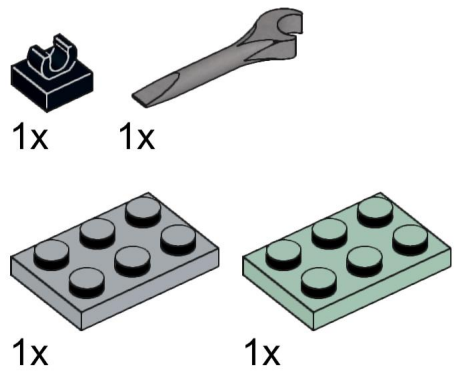

56

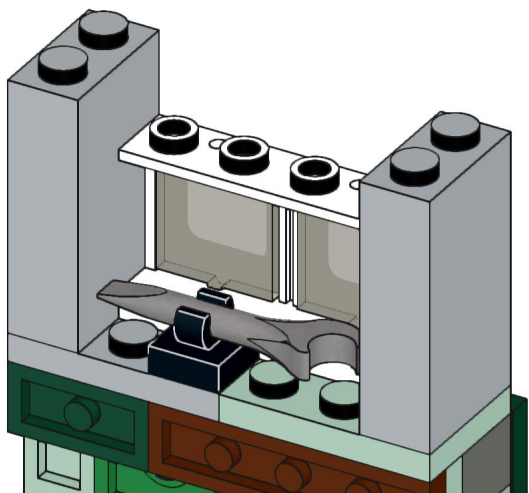
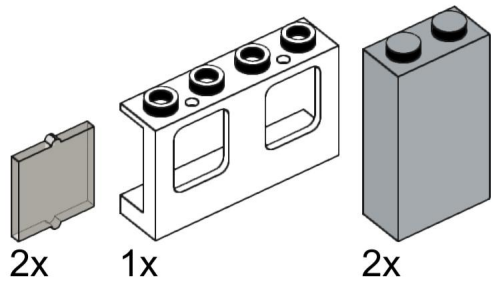

57

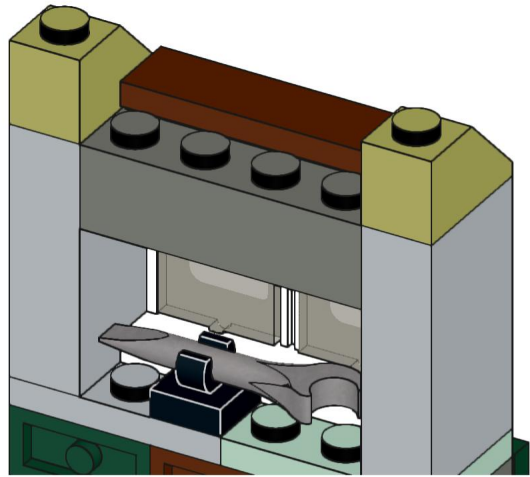
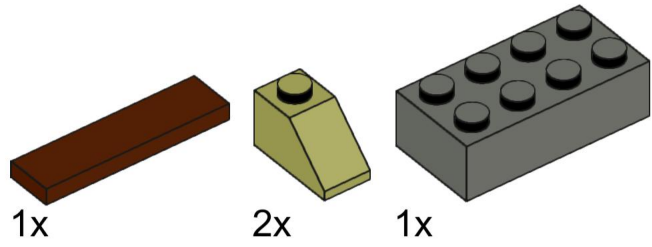

58

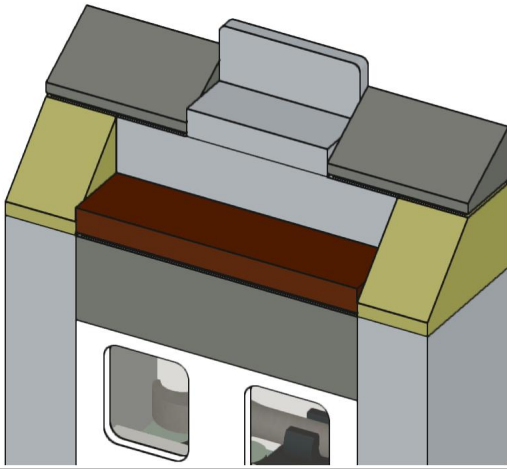
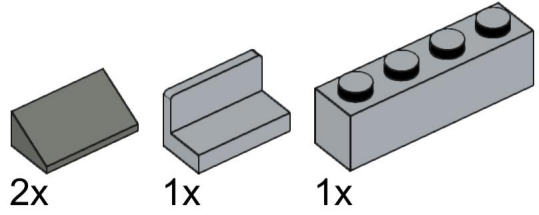

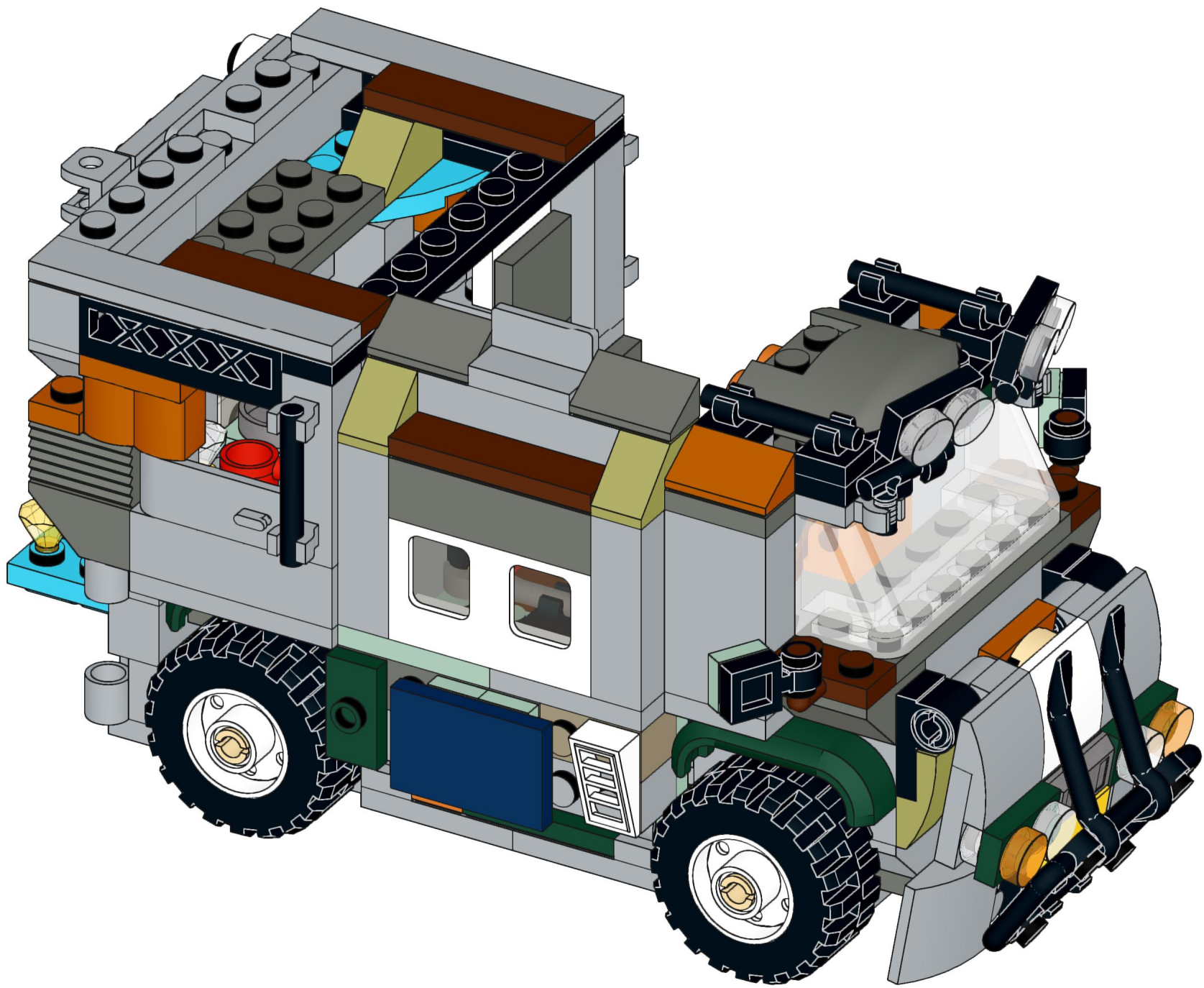

60

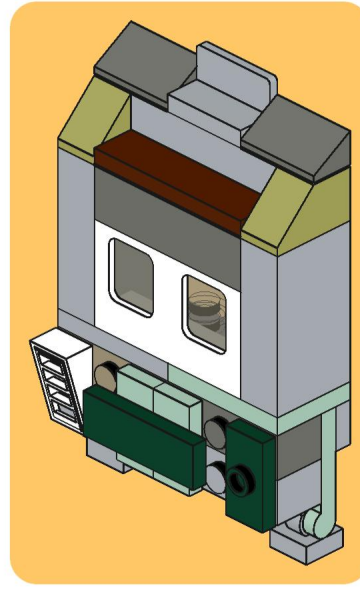
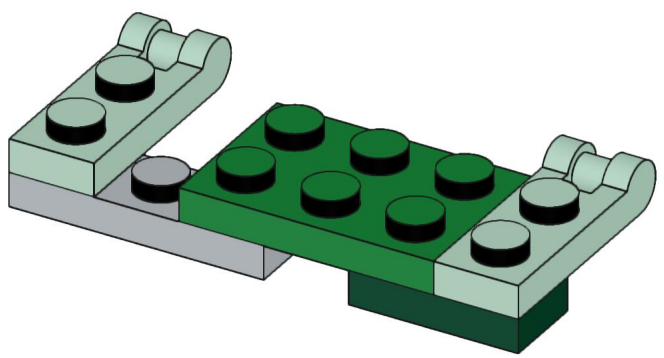
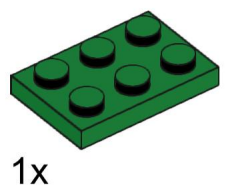
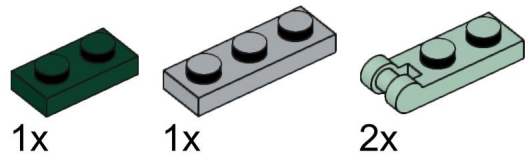

61

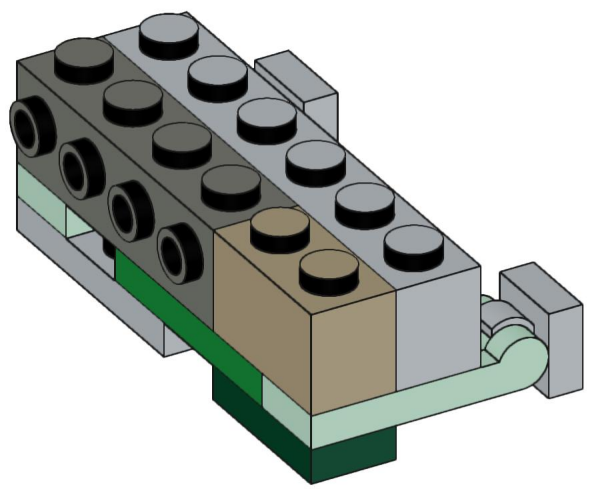
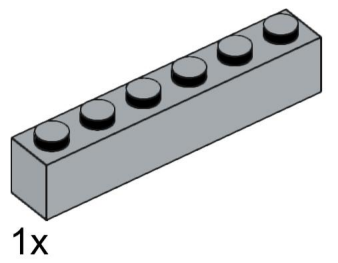
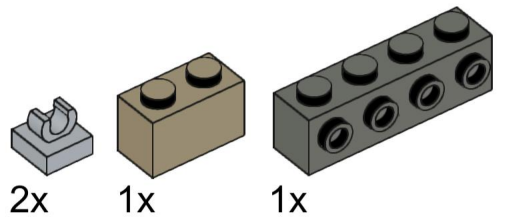

62

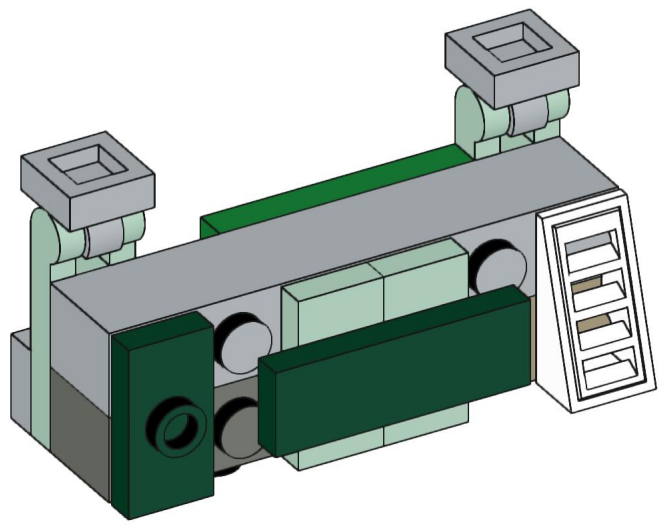
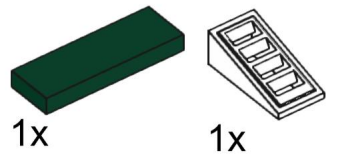
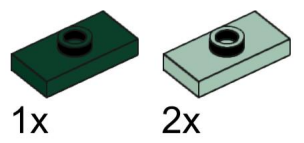

63

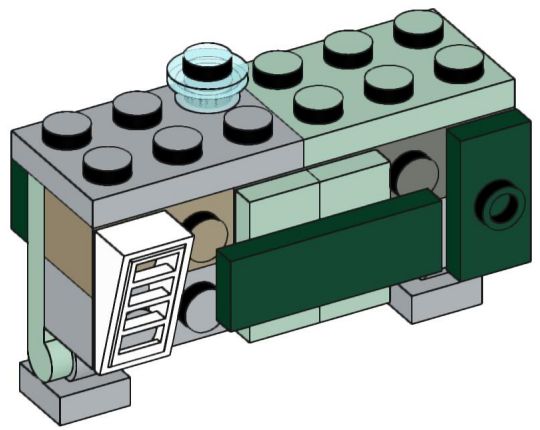
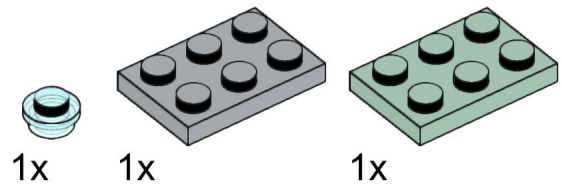

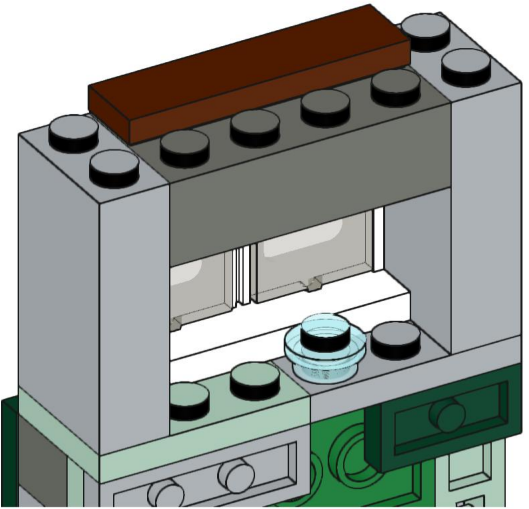
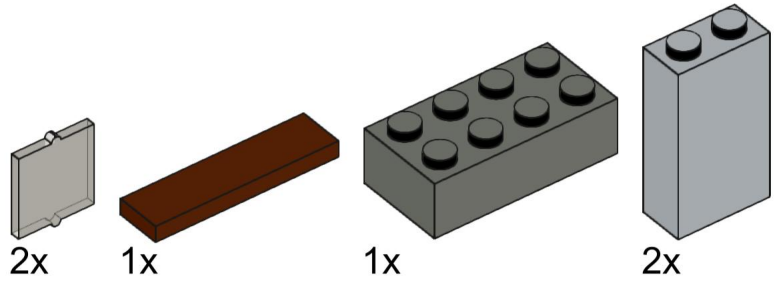

64

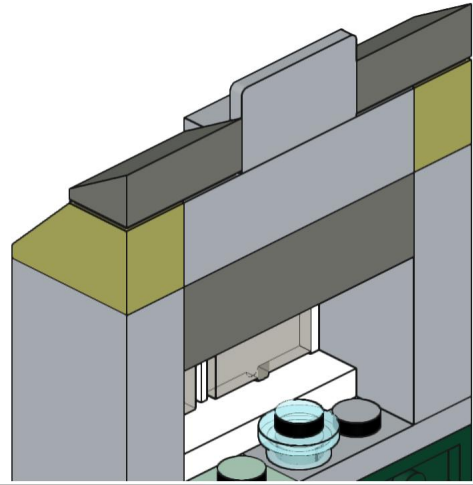
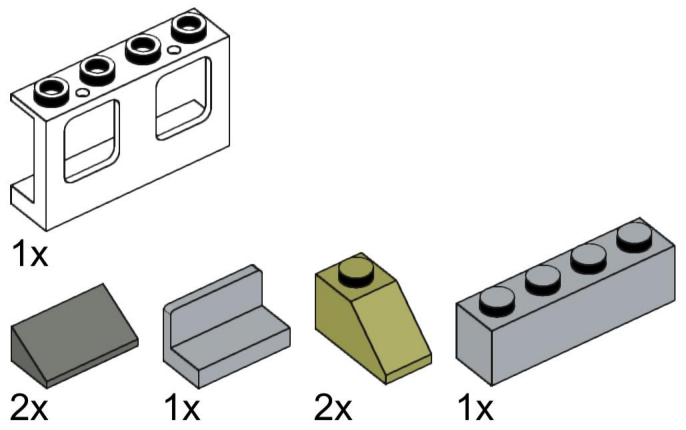

65

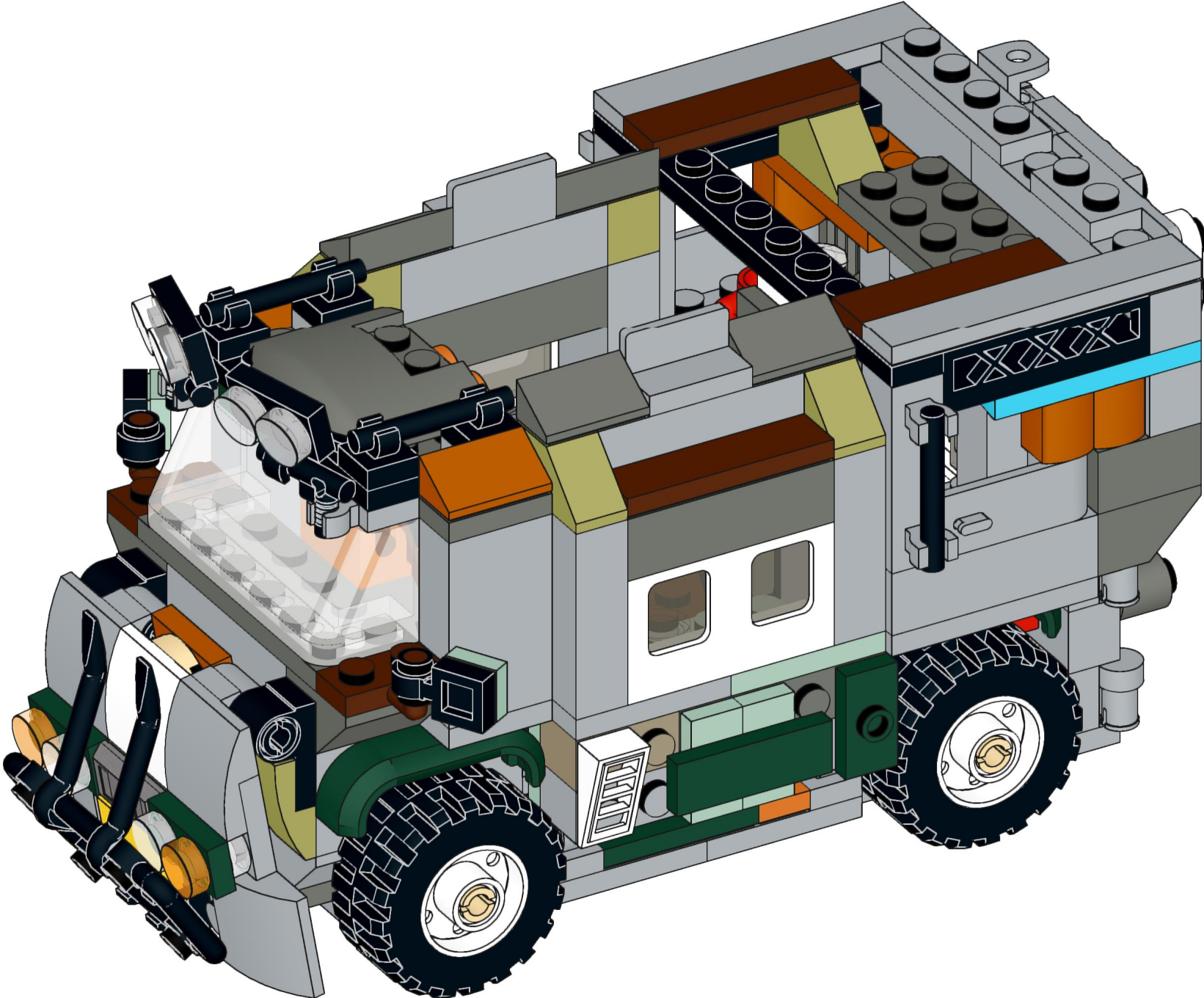

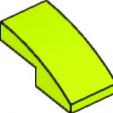
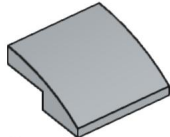

- 2x 
- 2x 
- 1x 

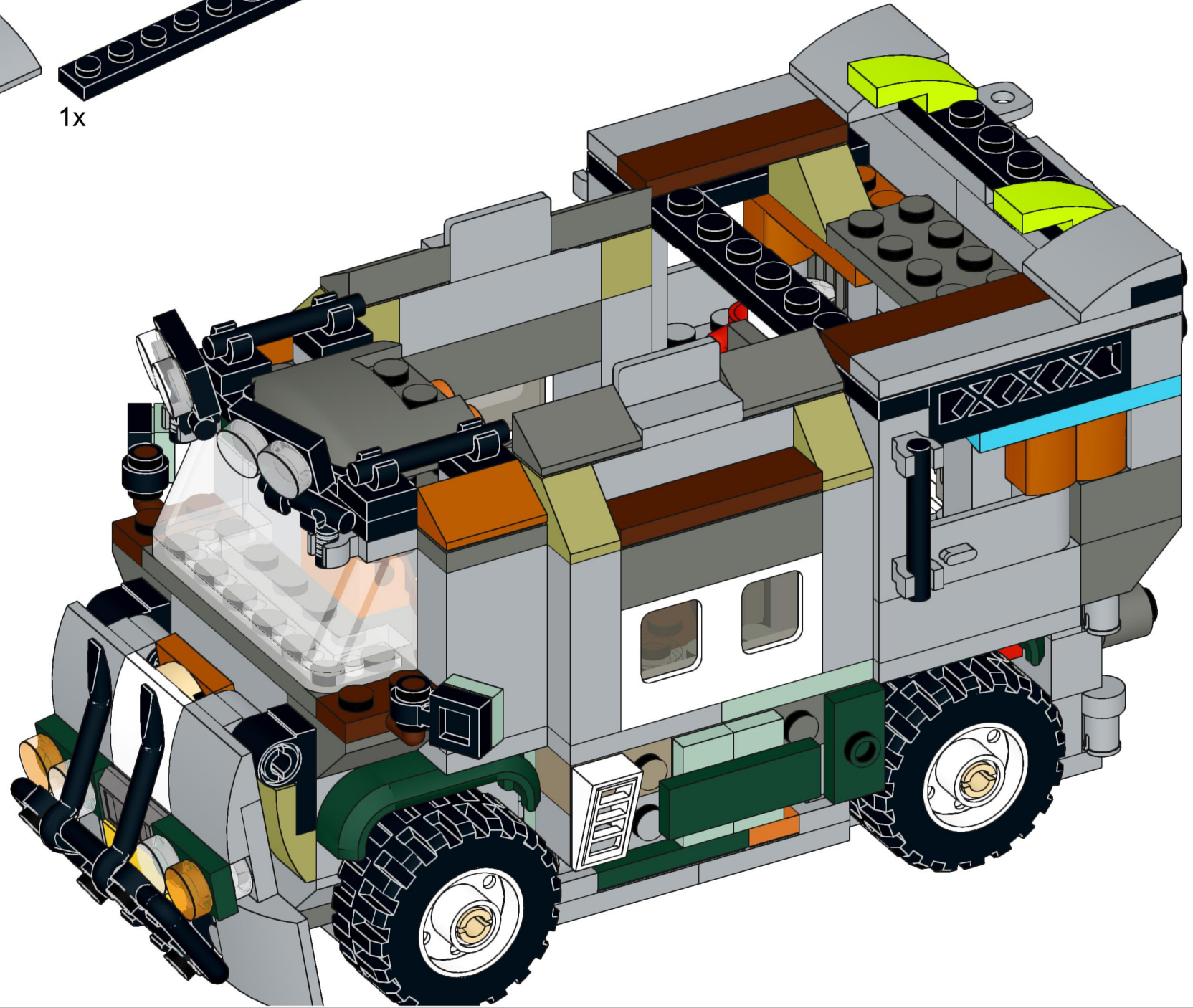

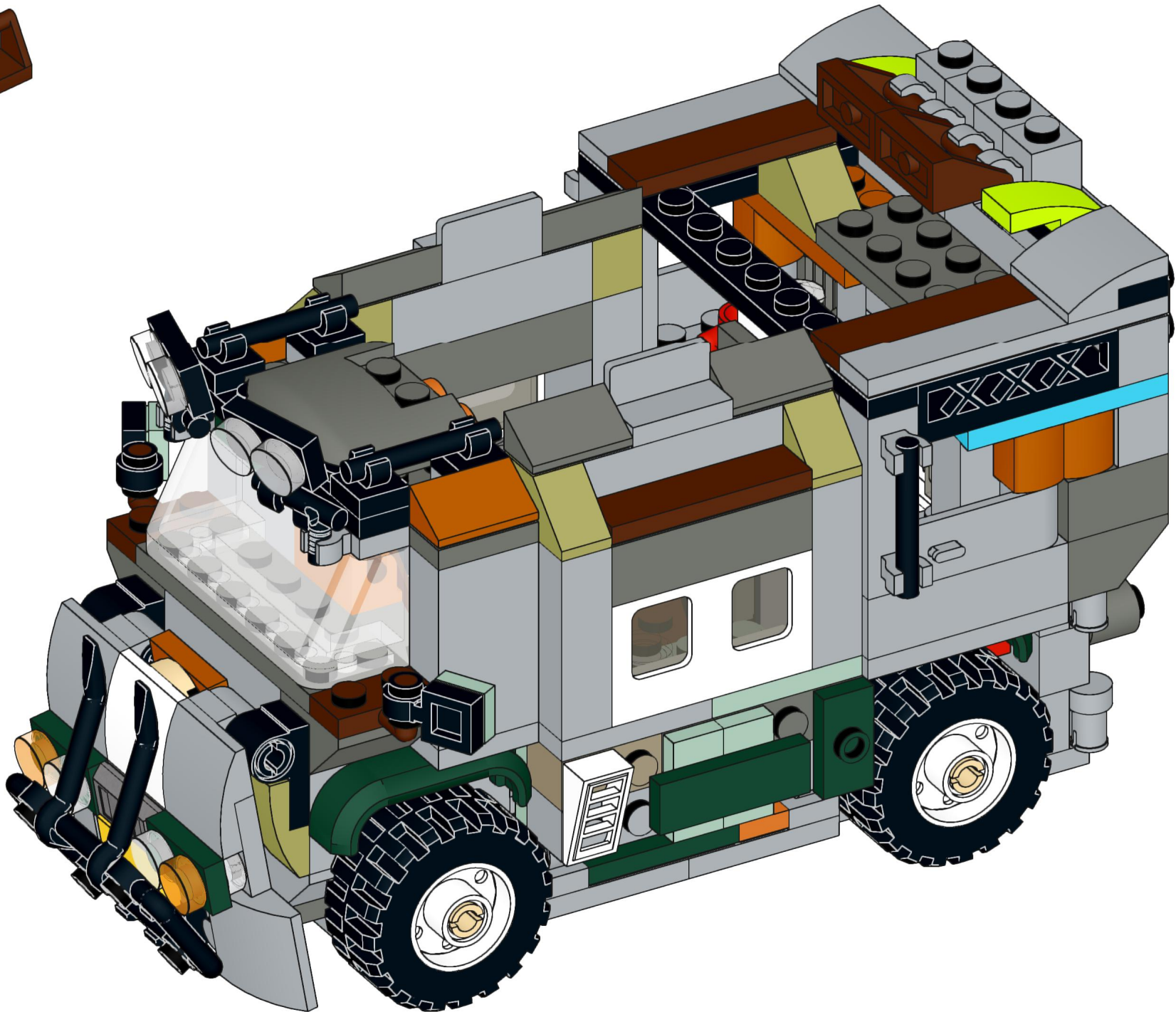
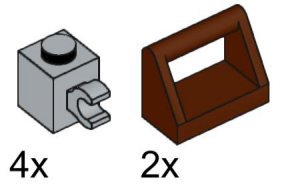

69

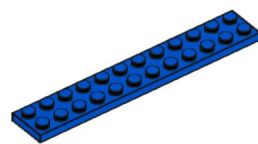

1x

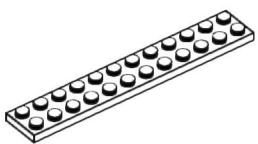

2x



1x

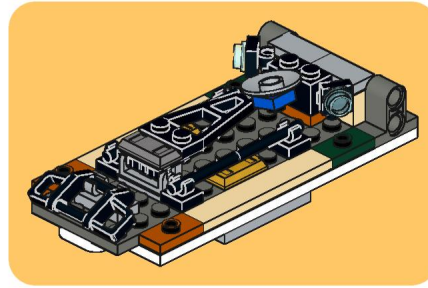
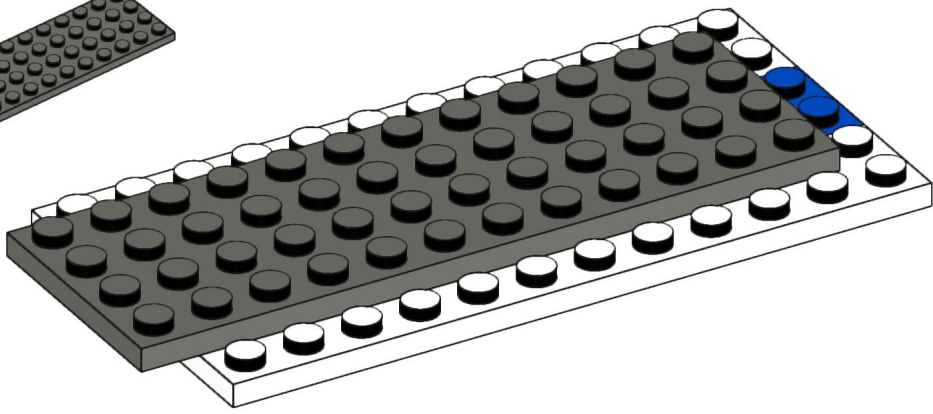

70



1x

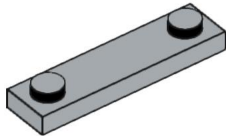

2x

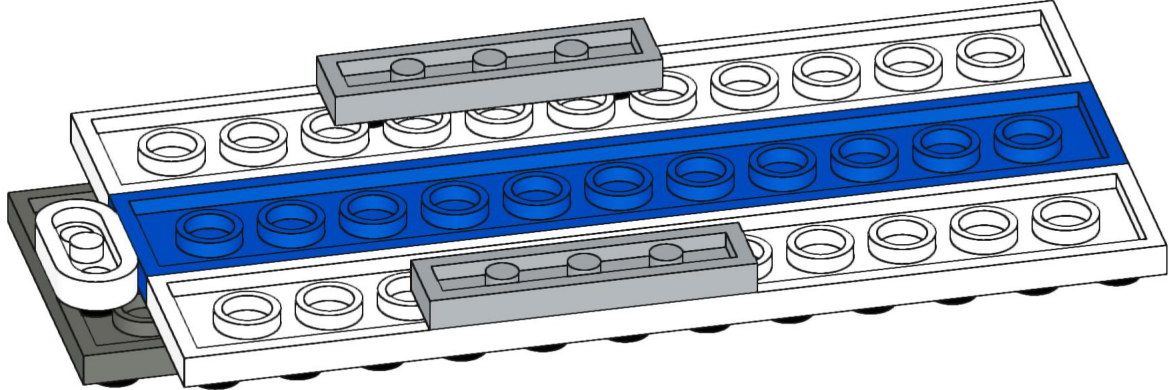

71



4x



2x



2x

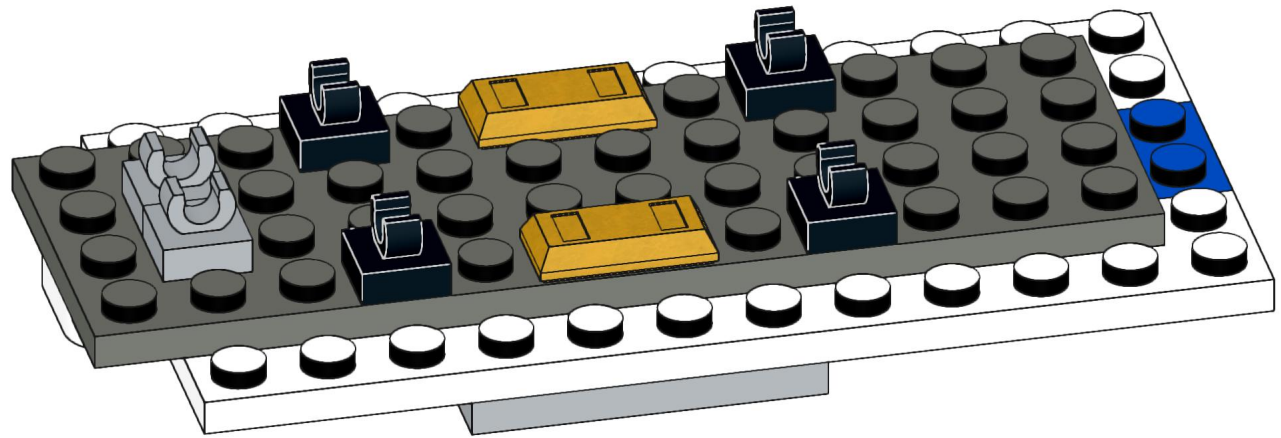

72

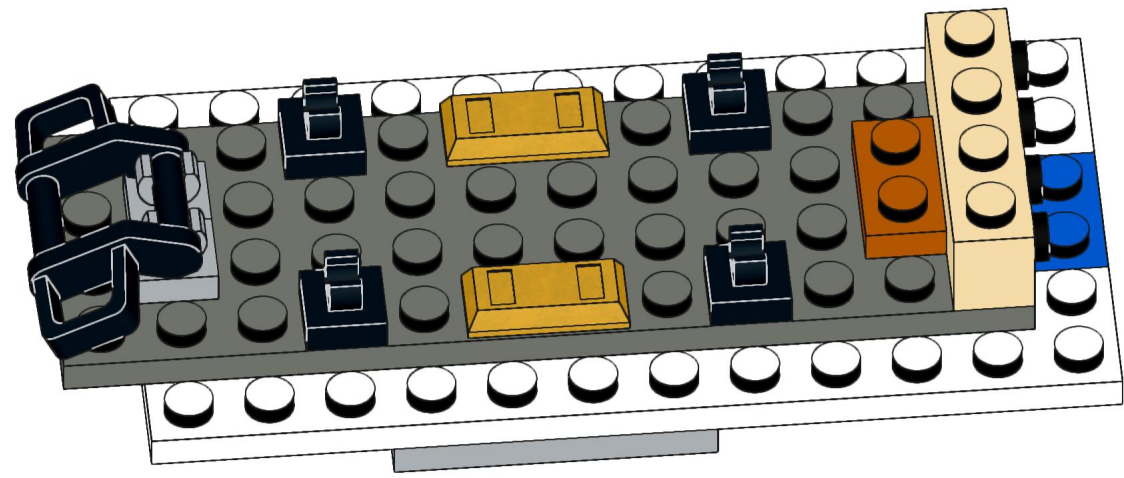
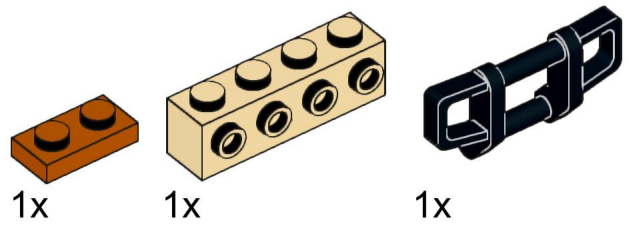

73

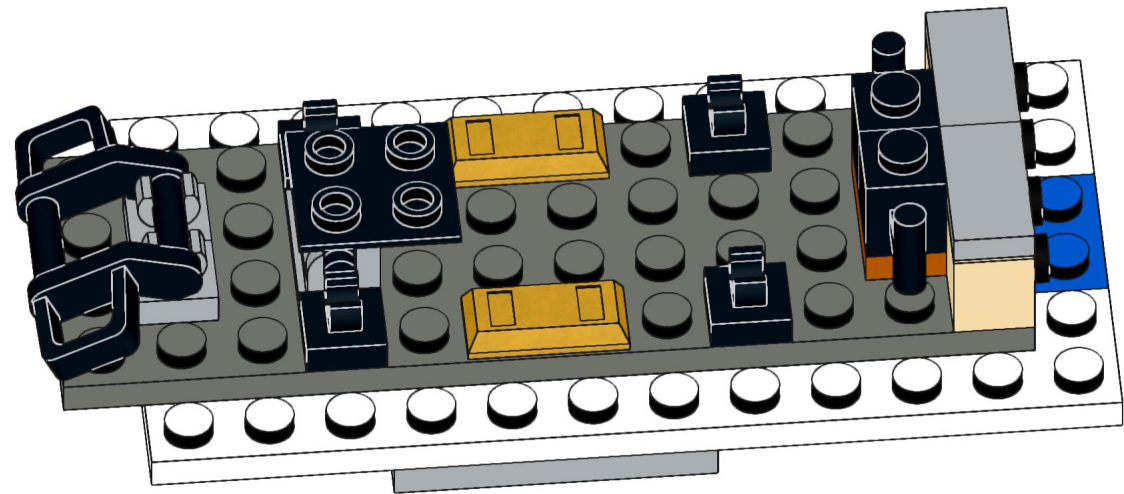
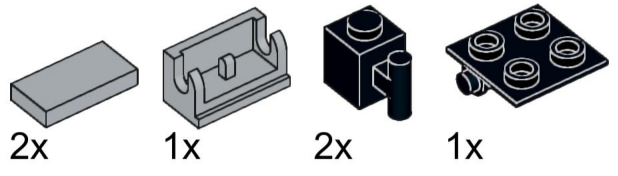

74

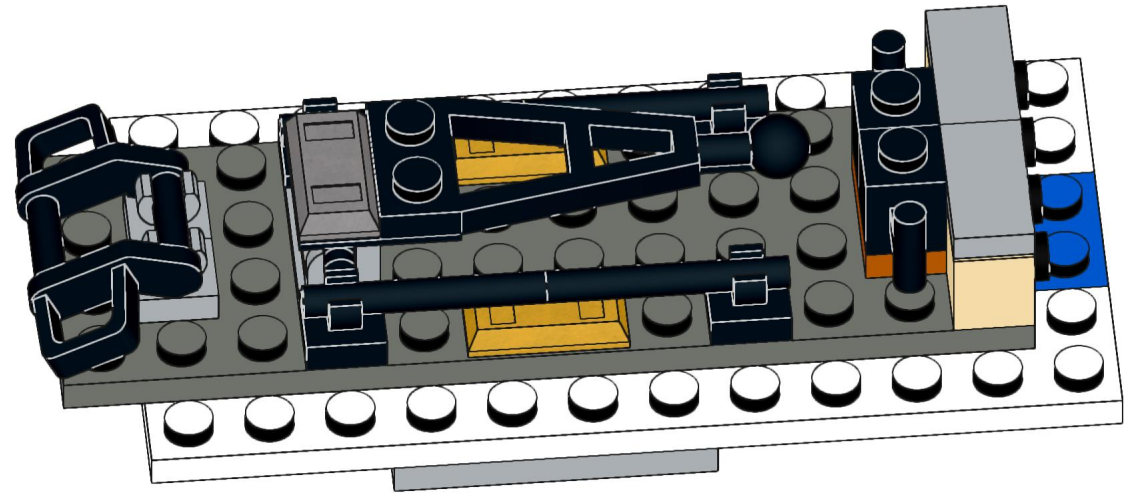
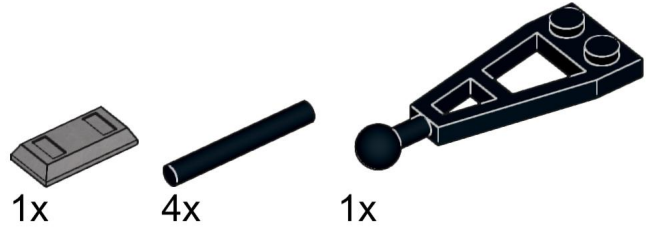

75

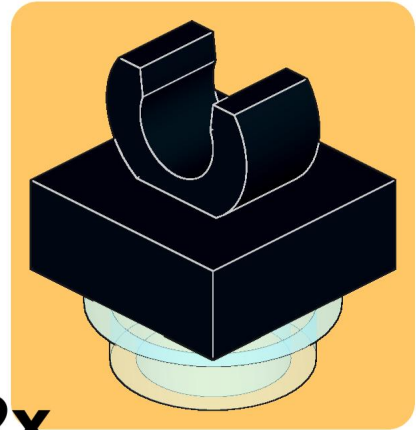
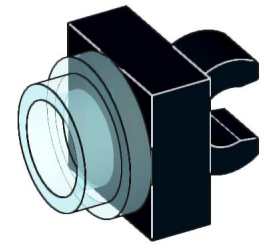
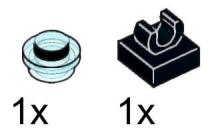

2x

76

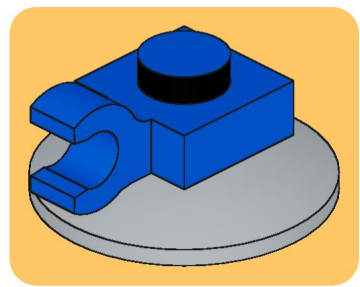
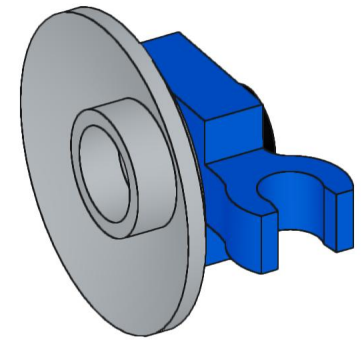
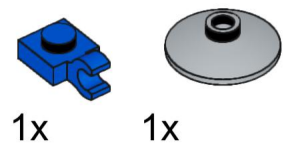

77

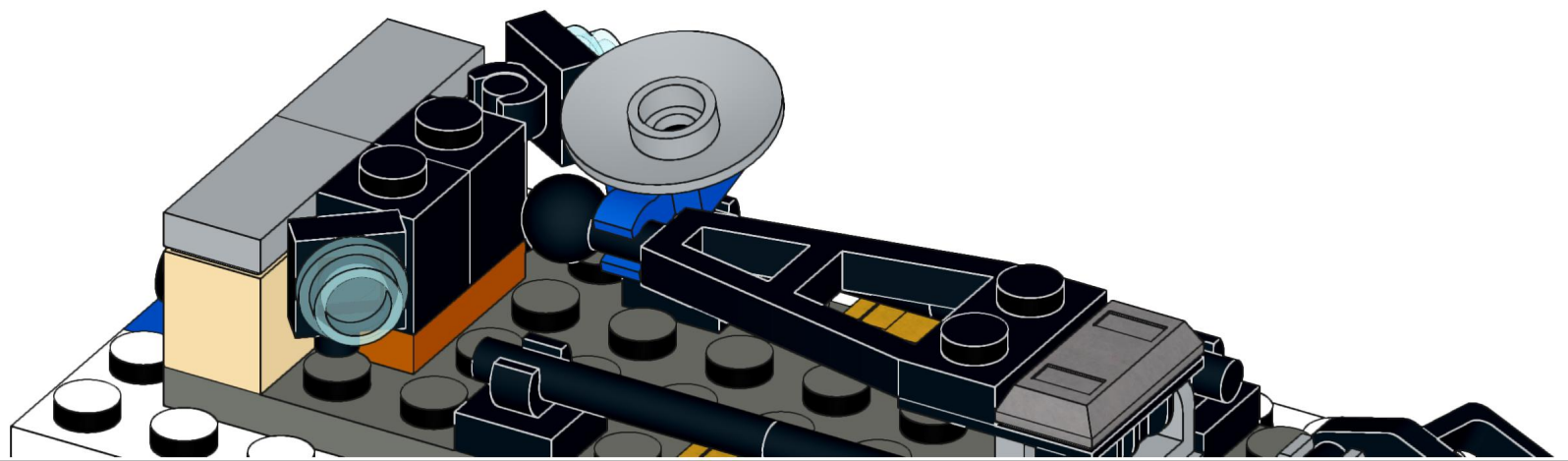

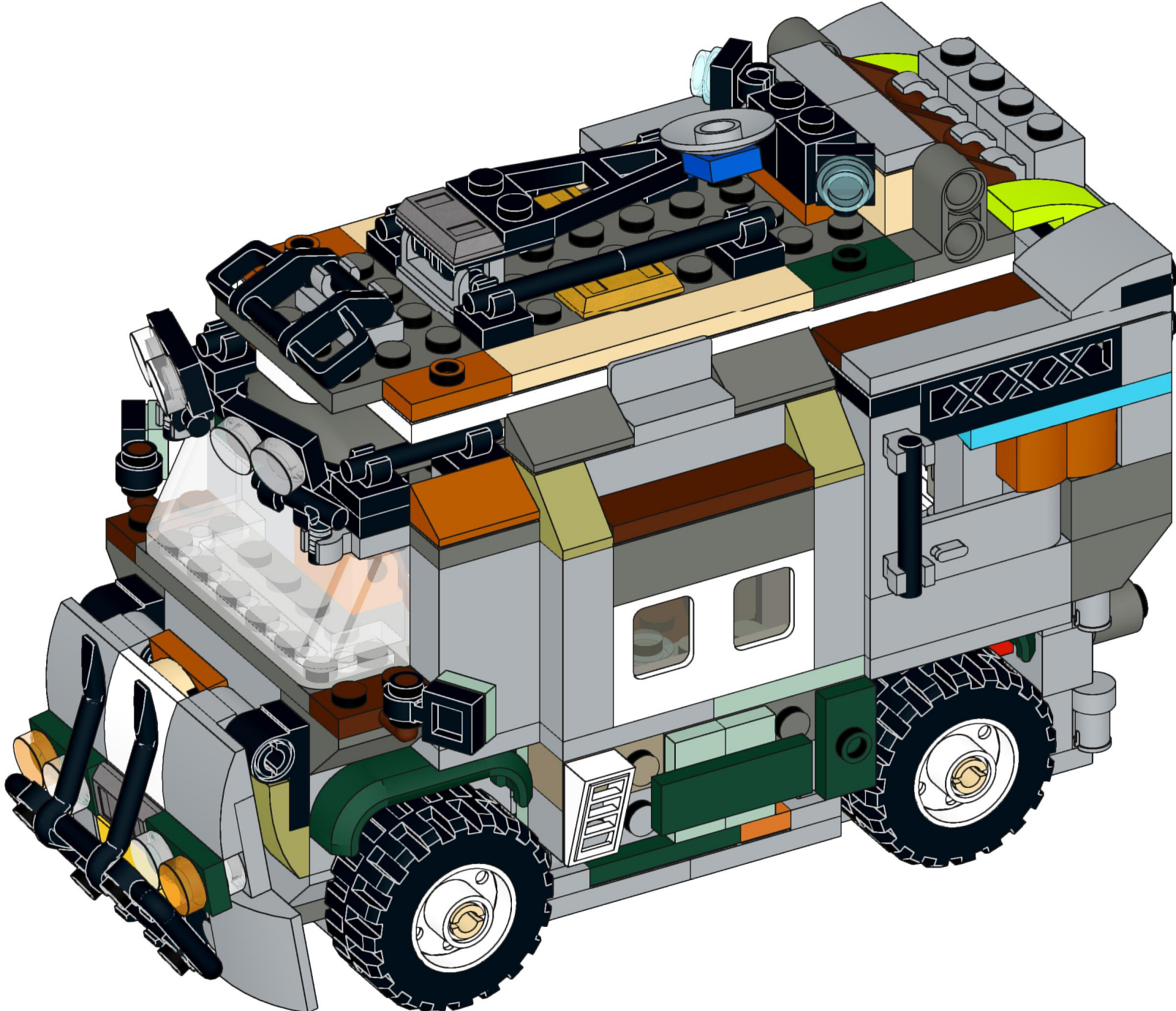

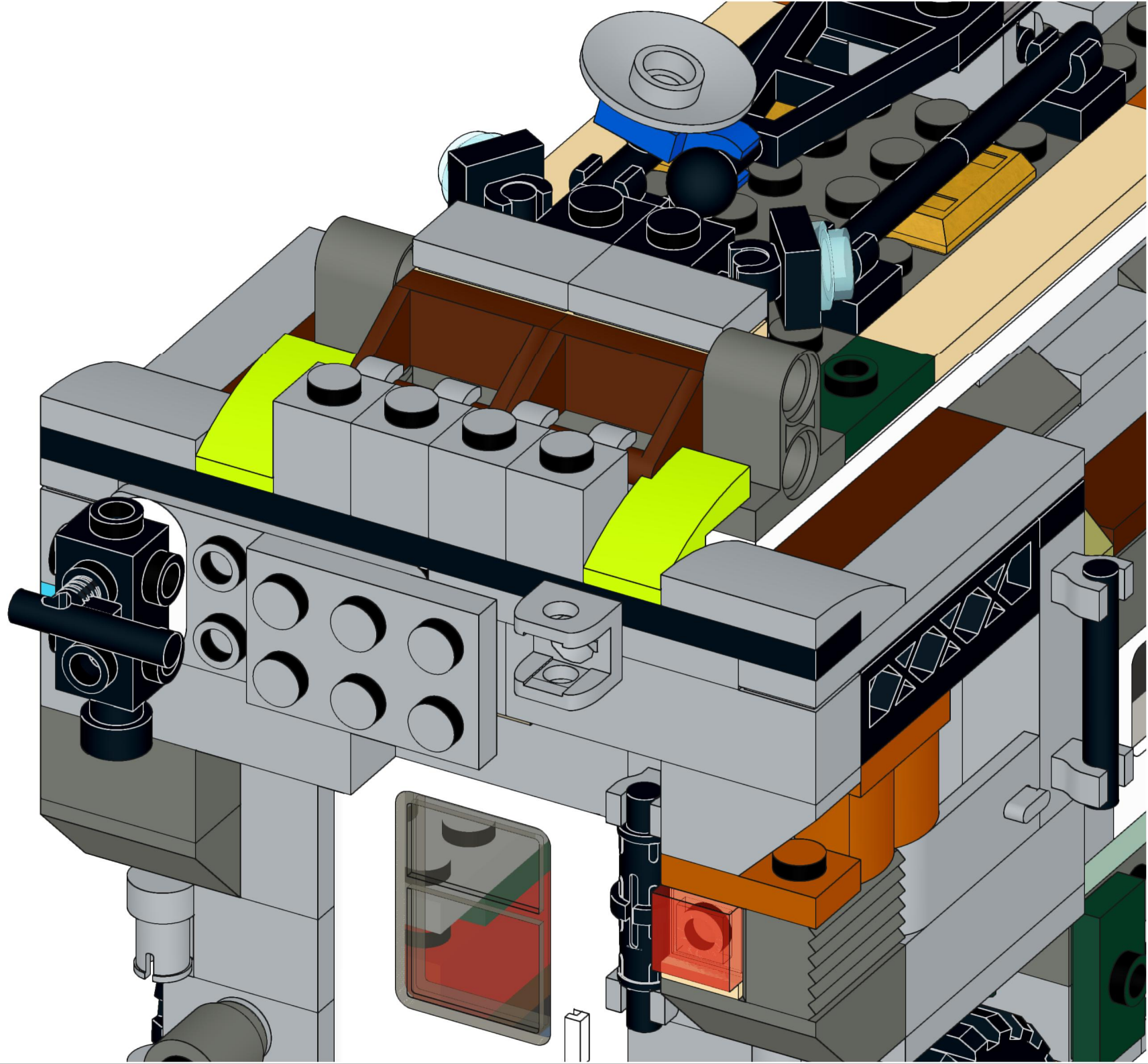
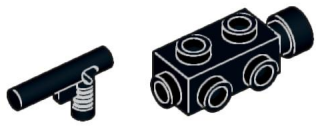

82

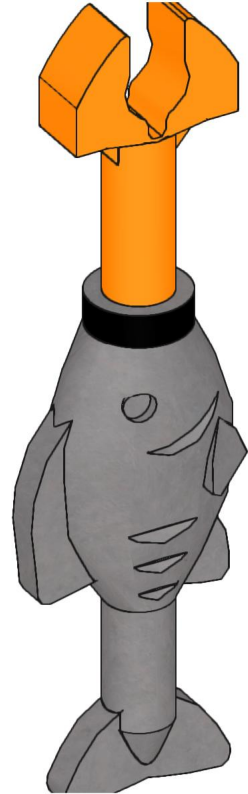
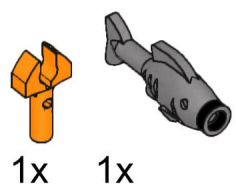

2x

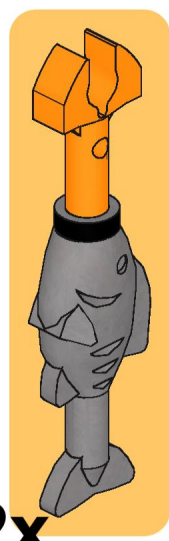

84

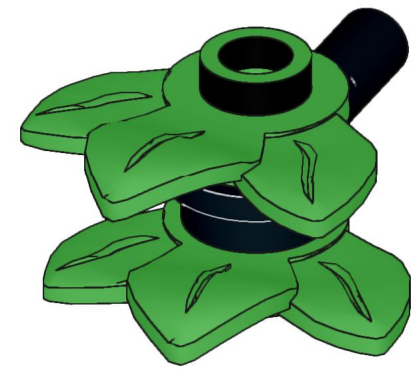
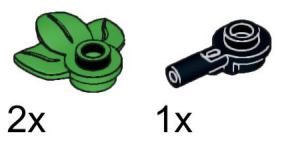

83

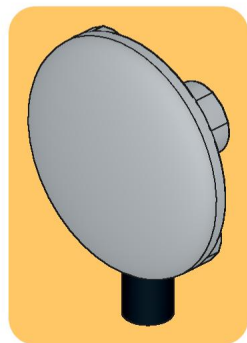
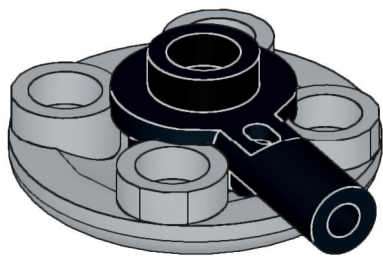
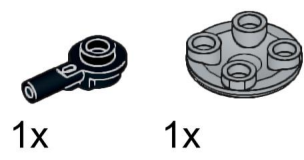

85

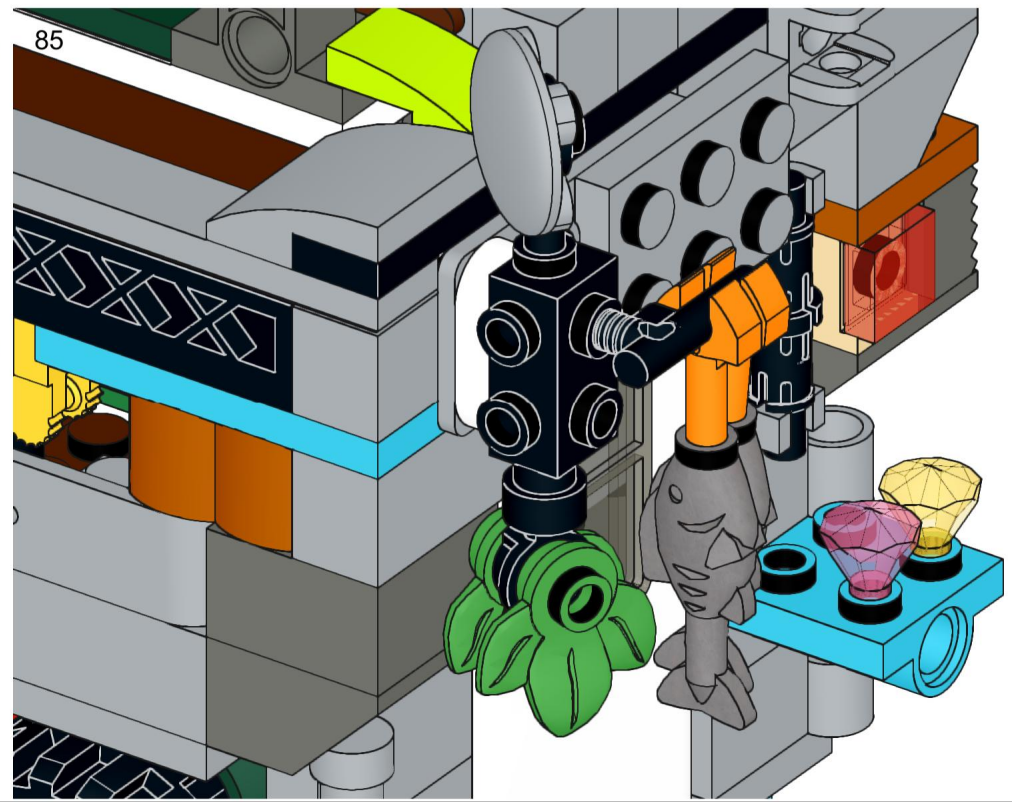

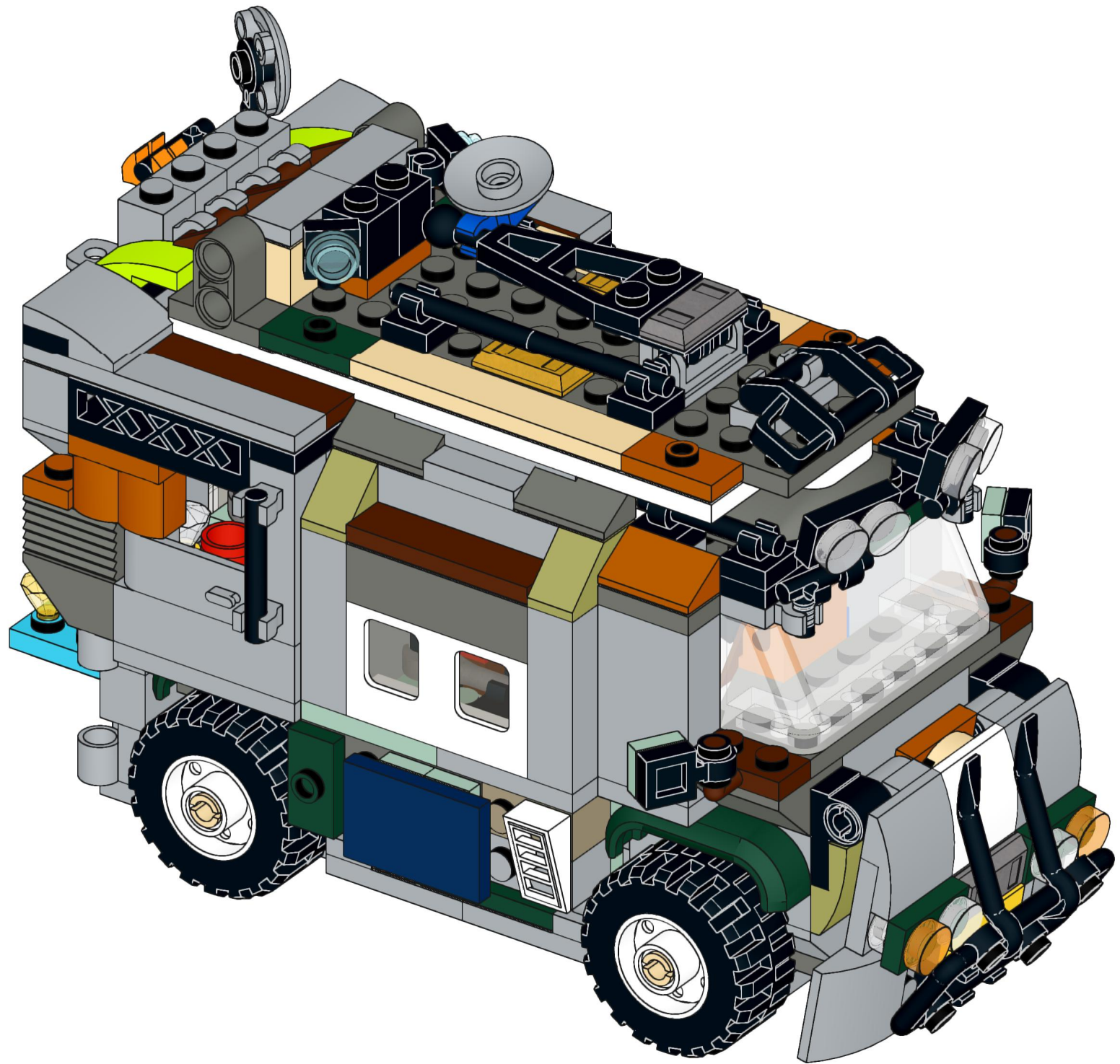



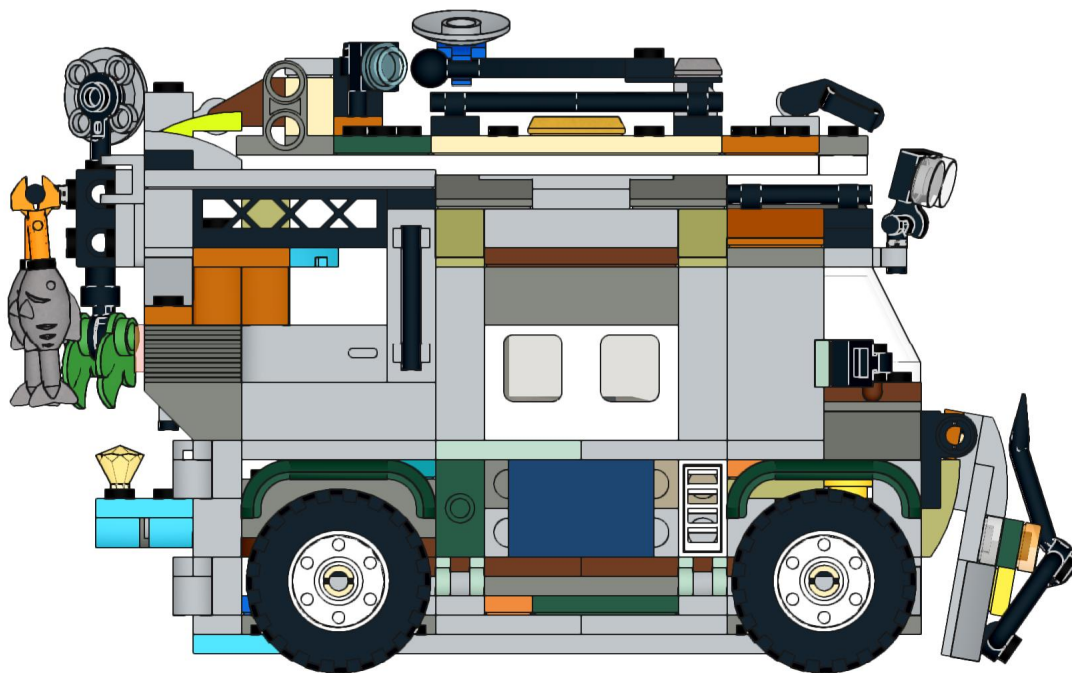
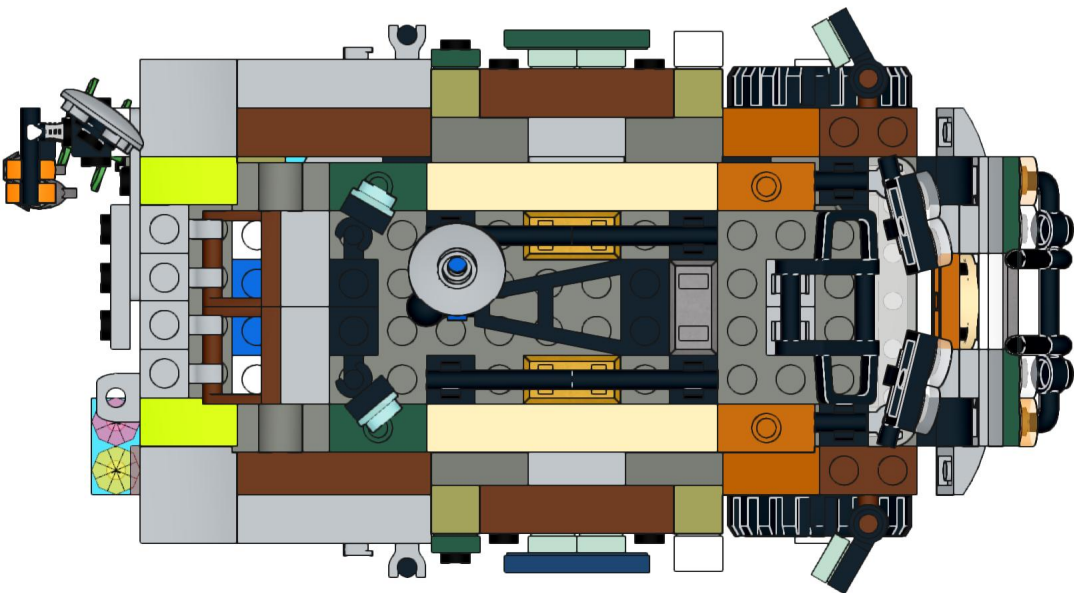
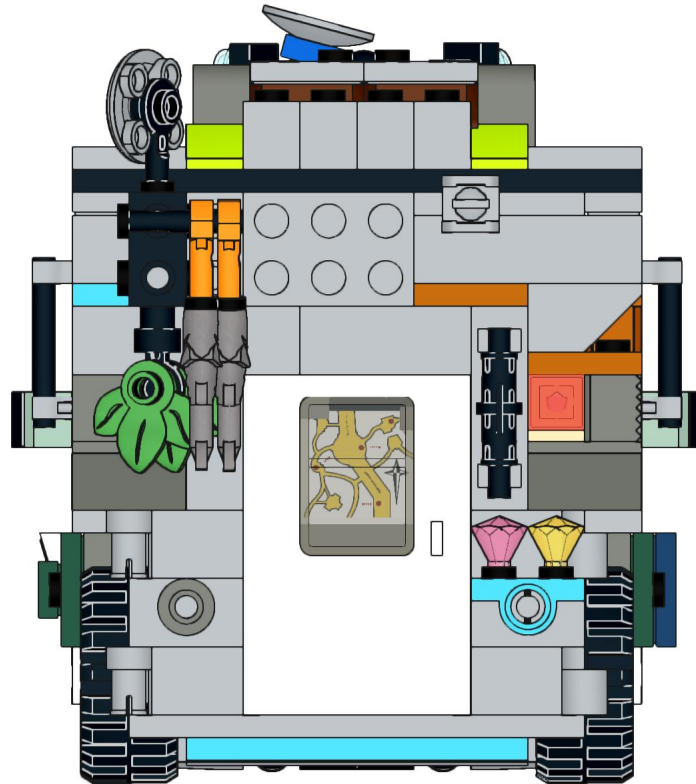
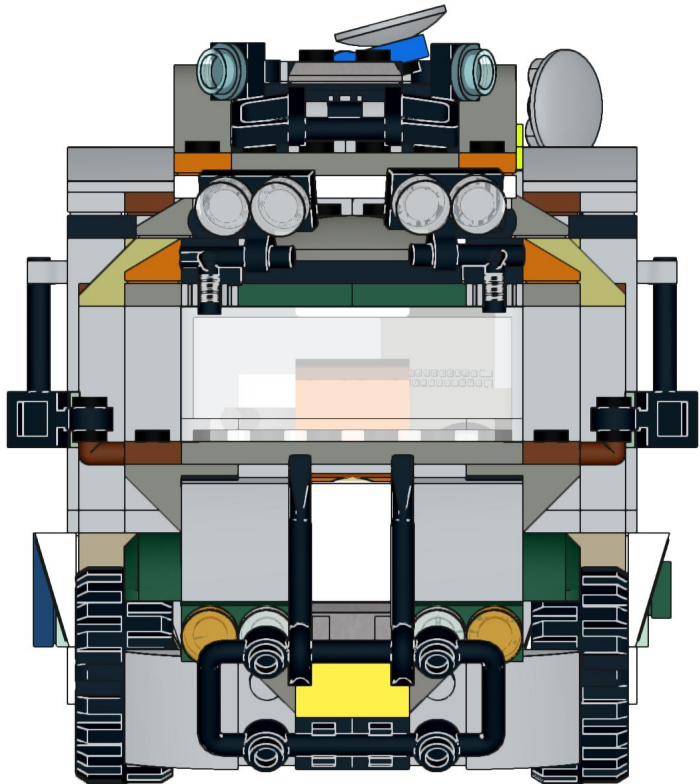

92

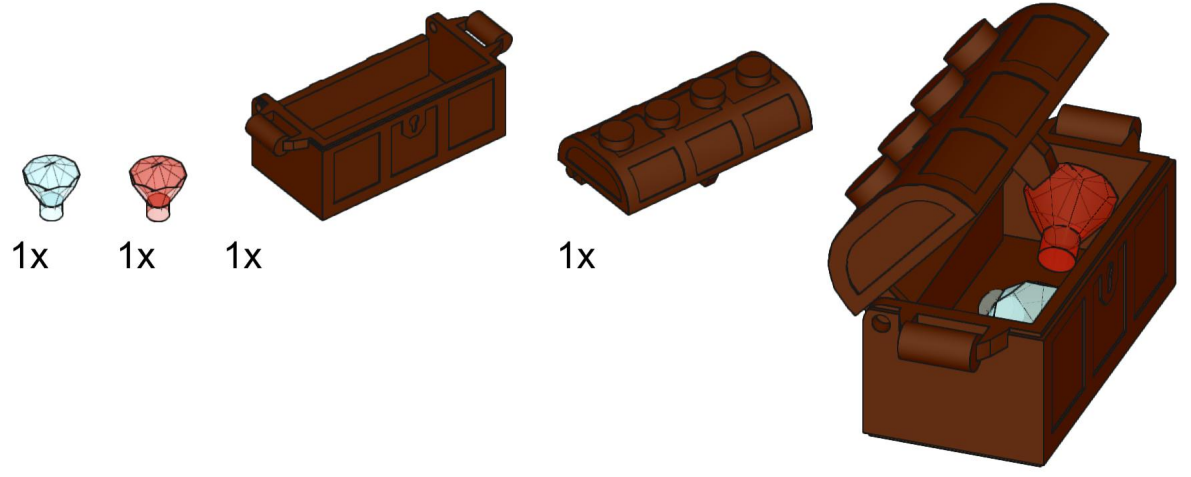

93

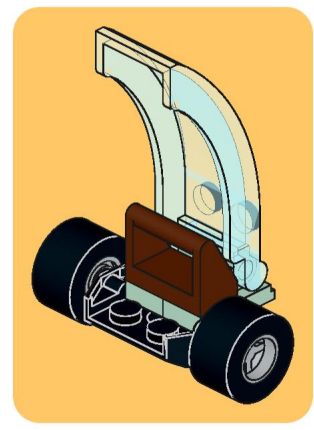

94

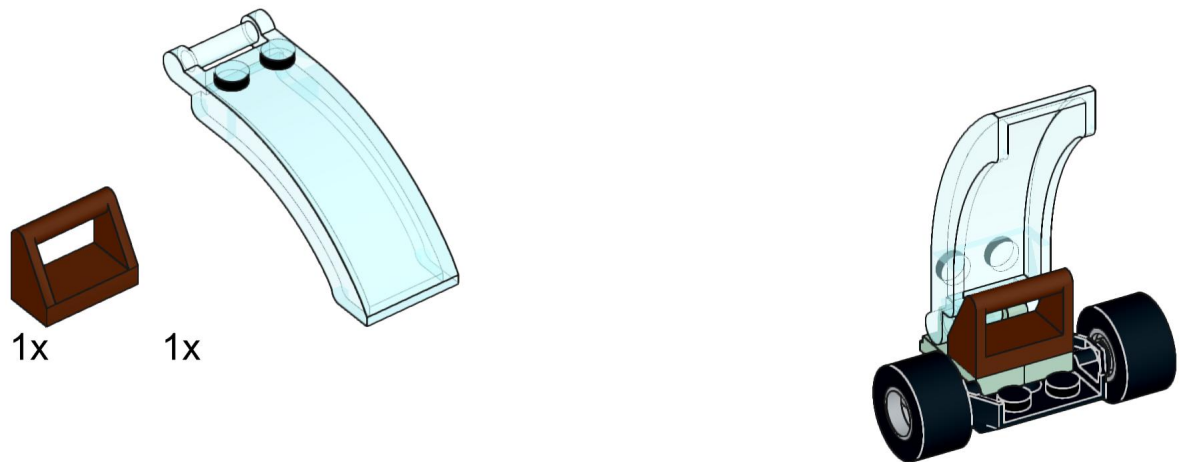



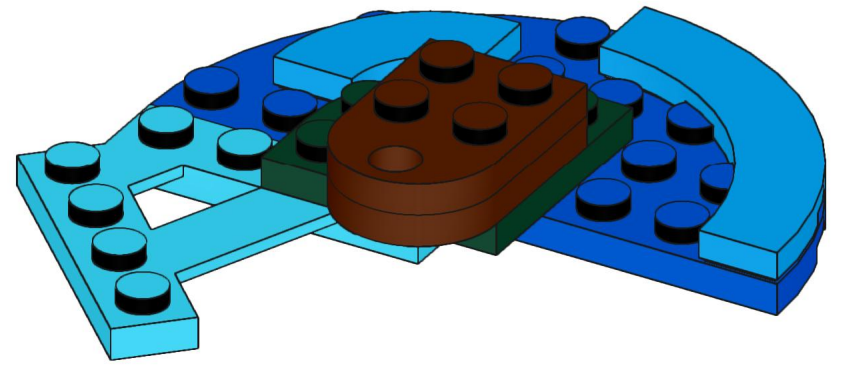
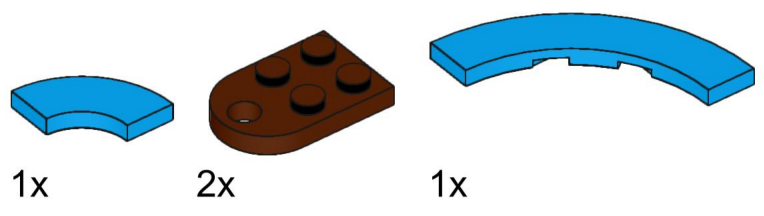
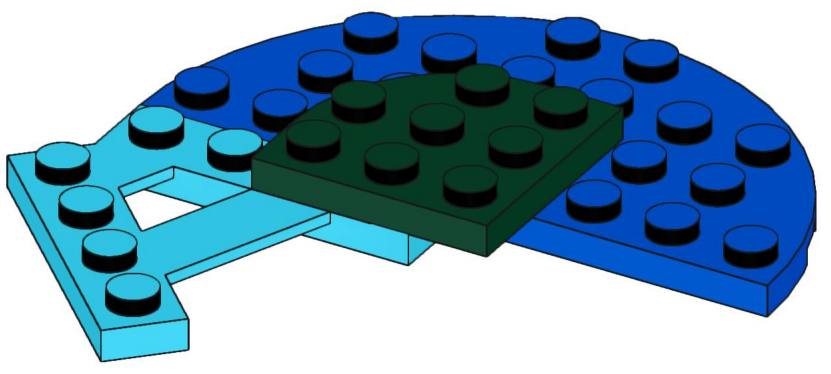
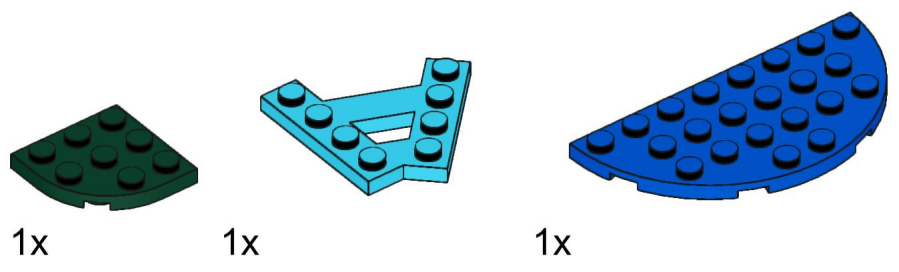

98

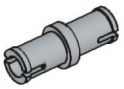

1x

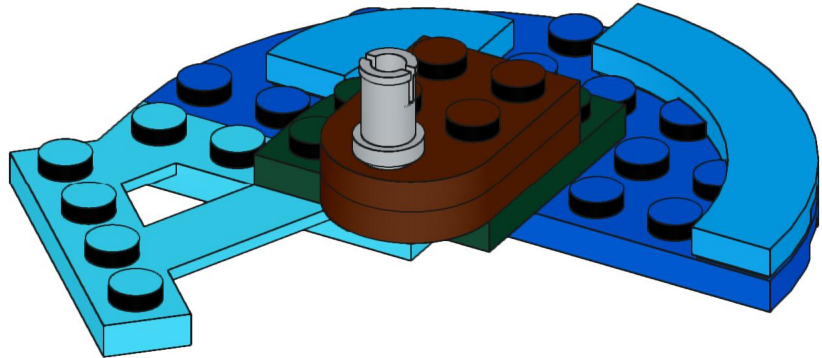

99



1x

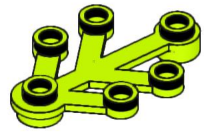

2x

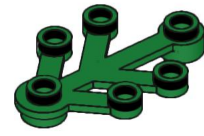

1x

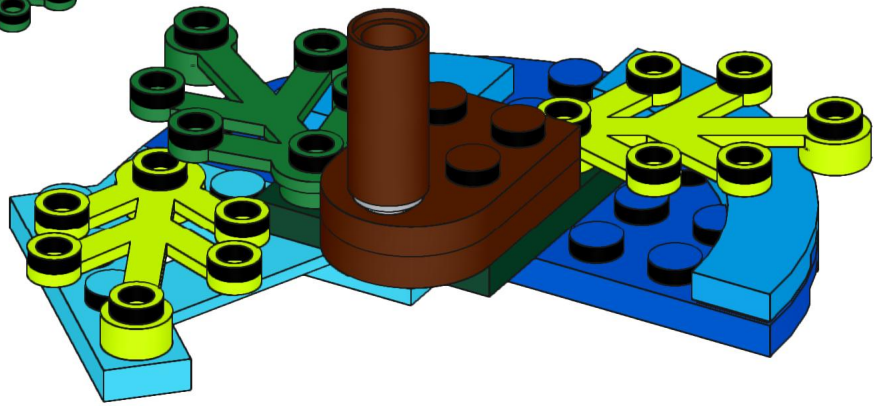

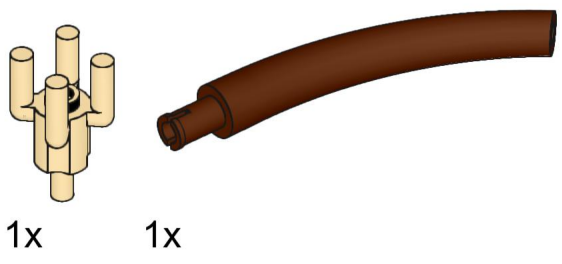
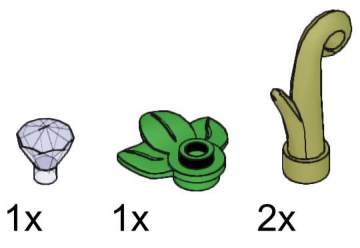

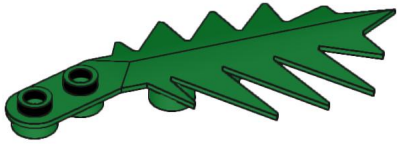

4x



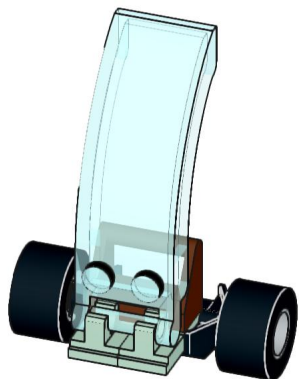







2x
64648, 95

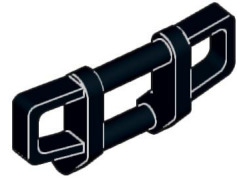

1x
35654, 11

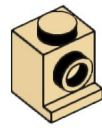

1x
4070, 2

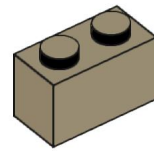

2x
3004, 69

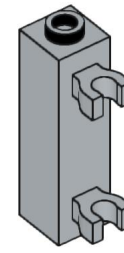

3x
60583b, 86

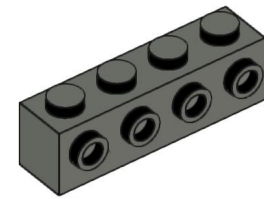

2x
30414, 85

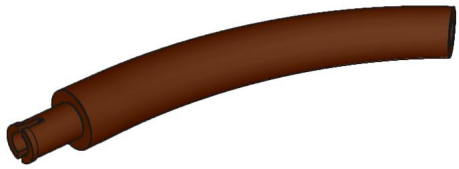

1x
23444, 11

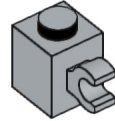

4x
60476, 86

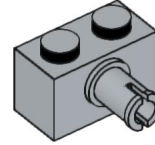

2x
2458, 86



2x
2921, 11

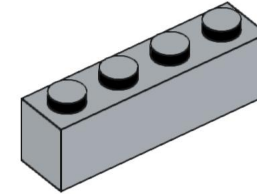
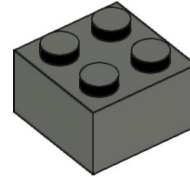

9x
3010, 86

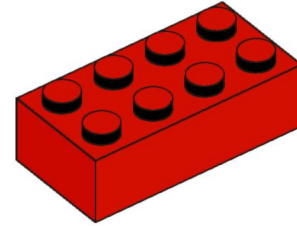

1x
3001, 5

1x
40378, 88

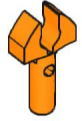

2x
48729b, 4

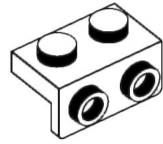

2x
99781, 1

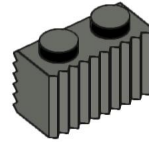

1x
2877, 85

1x
3003, 85

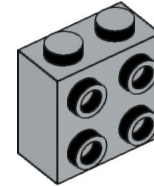

2x
22885, 86

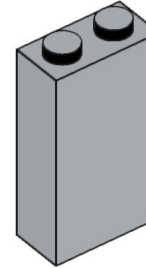

7x
22886, 86

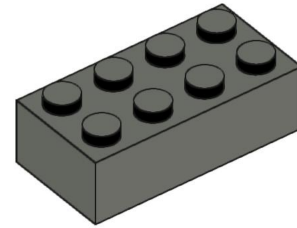

3x
3001, 85



2x
32828, 11

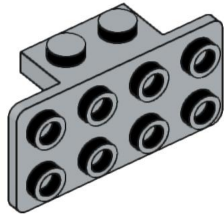

1x
93274, 86

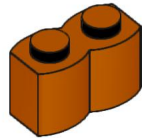

2x
30136, 68

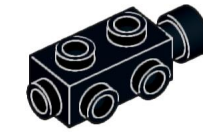

1x
4595, 11

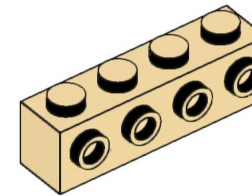

1x
30414, 2

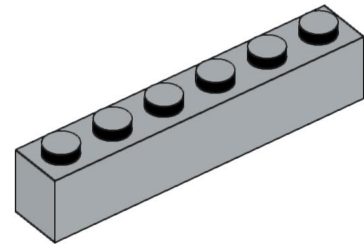

4x
3009, 86



9x
87994, 11



2x
3062b, 85

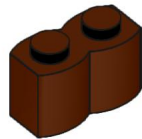

4x
30136, 88

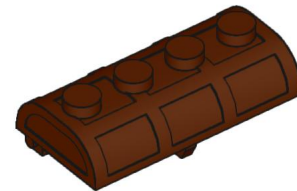

1x
4739a, 88

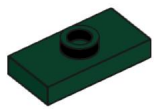

4x
15573, 80

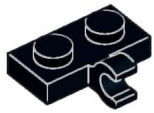

2x
11476, 11

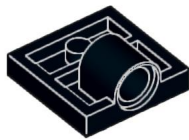

4x
10247, 11

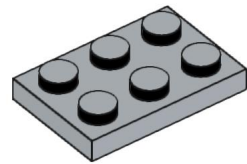

8x
3021, 86

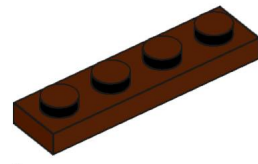

1x
3710, 88



1x
6157, 11



3x
3666, 11

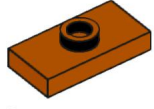

2x
15573, 68

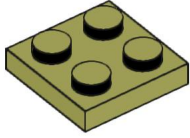

2x
3022, 155

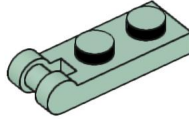

4x
60478, 48

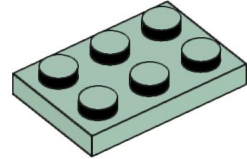

2x
3021, 48

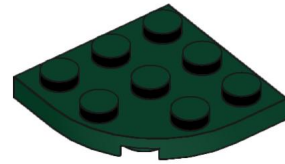

1x
30357, 80

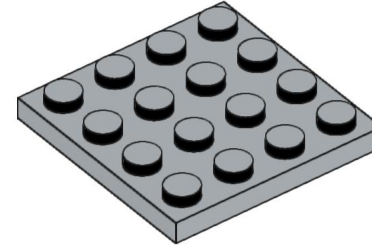

2x
3031, 86

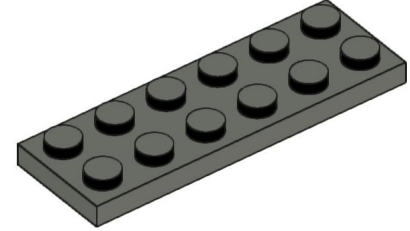

1x
3795, 85



2x
35480, 1

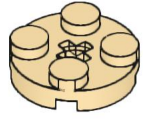

1x
4032, 2

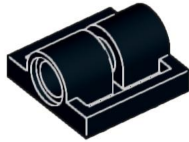

1x
2817, 11

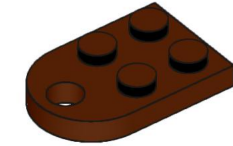

4x
3176, 88

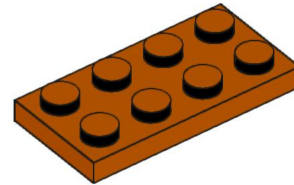

1x
3020, 68

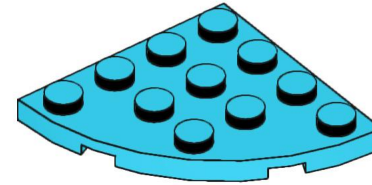

1x
30565, 156

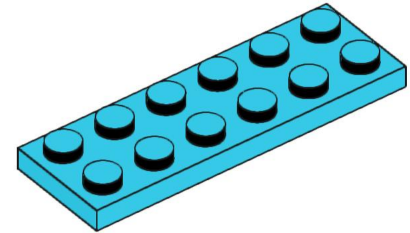

1x
3795, 156

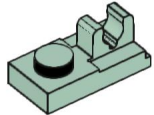

2x
92280, 48

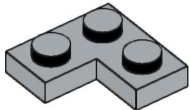

2x
2420, 86

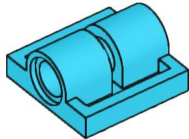

1x
2817, 156

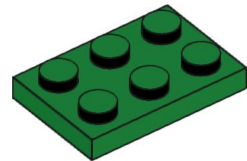

3x
3021, 6

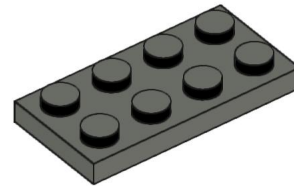

3x
3020, 85

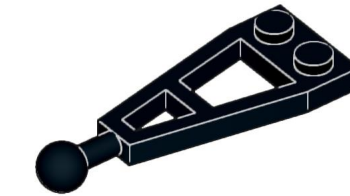

1x
2508, 11

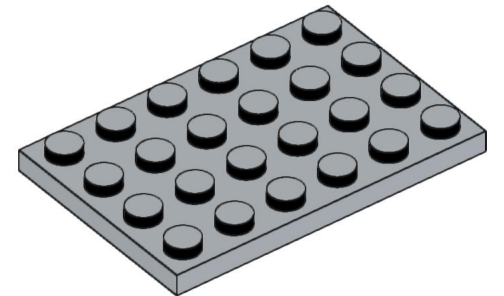

1x
3032, 86

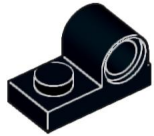

2x
11458, 11

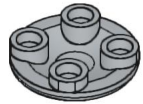

1x
2654, 86

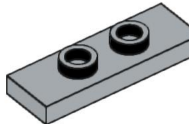

4x
34103, 86

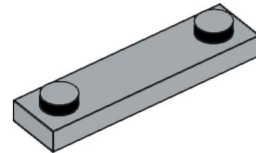

2x
92593, 86

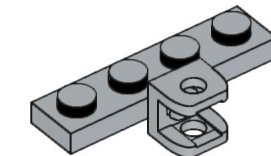

1x
98263, 86

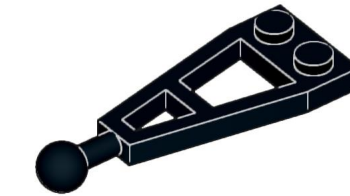

1x
2508, 11

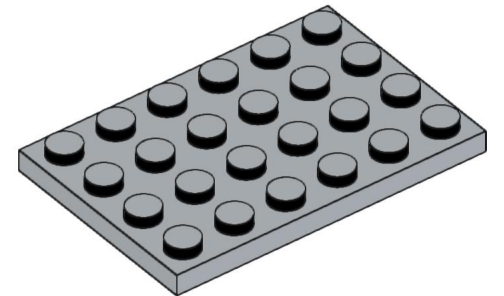

1x
3032, 86

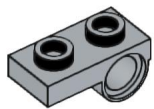

2x
18677, 86

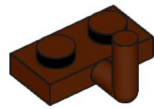

4x
4623, 88

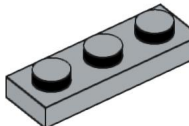

2x
3623, 86

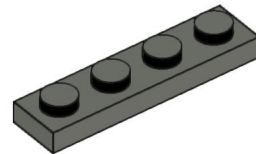

2x
3710, 85

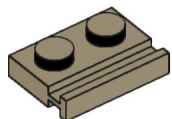

1x
32028, 69

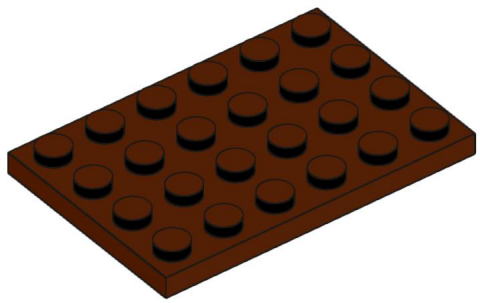

2x
3032, 88

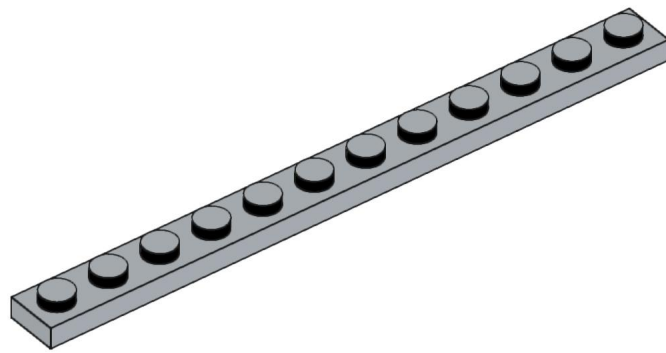

4x
60479, 86

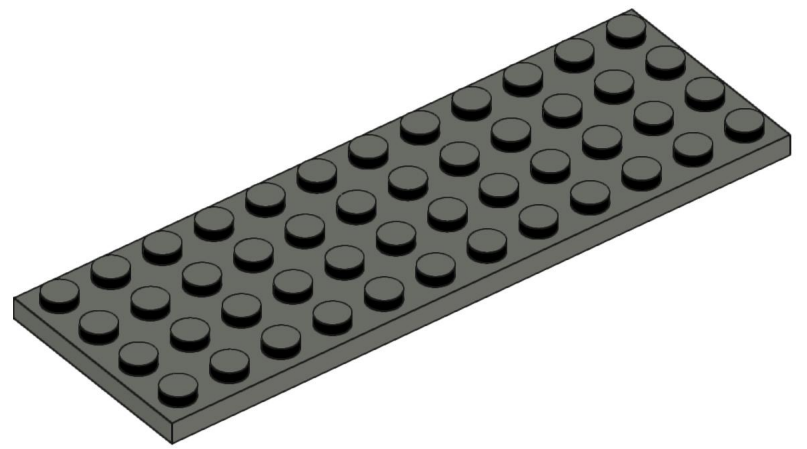

1x
3029, 85

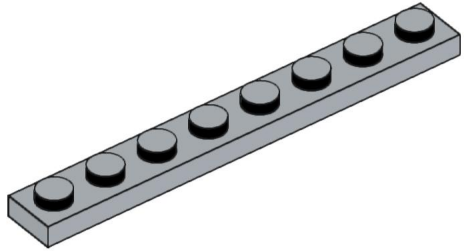

1x
3460, 86

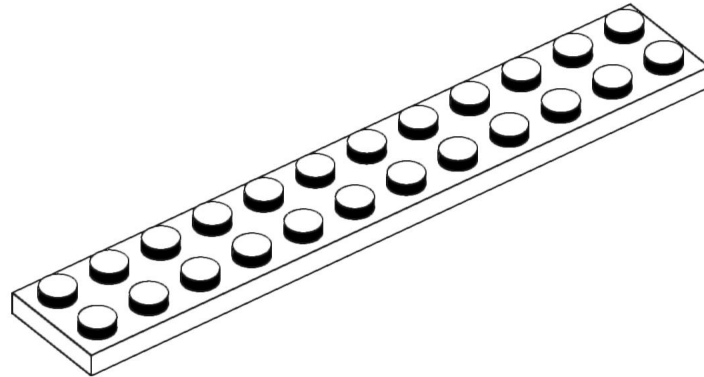

2x
2445, 1

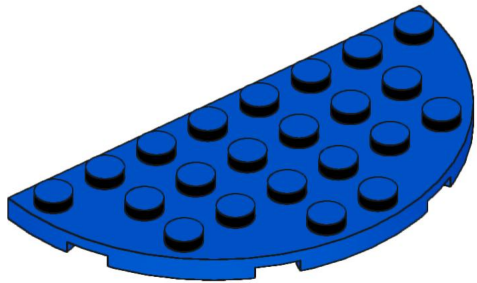

1x
22888, 7

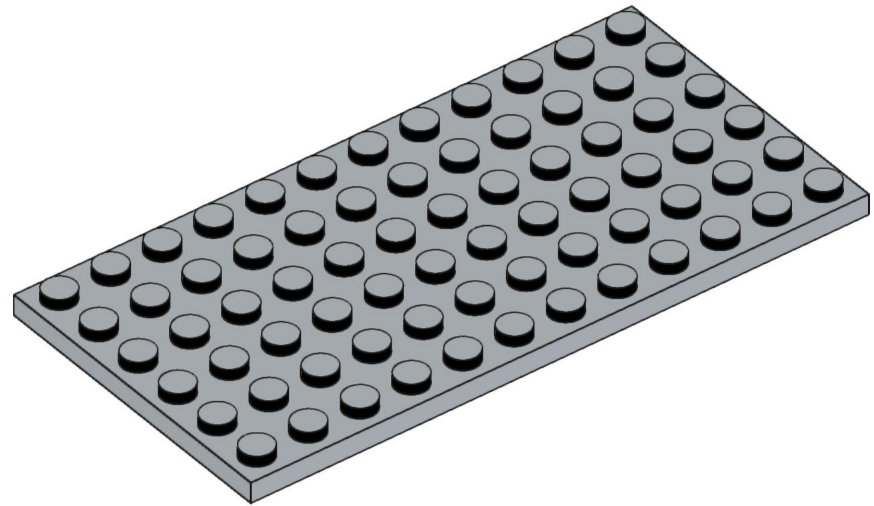

1x
3028, 86



2x
4477, 11

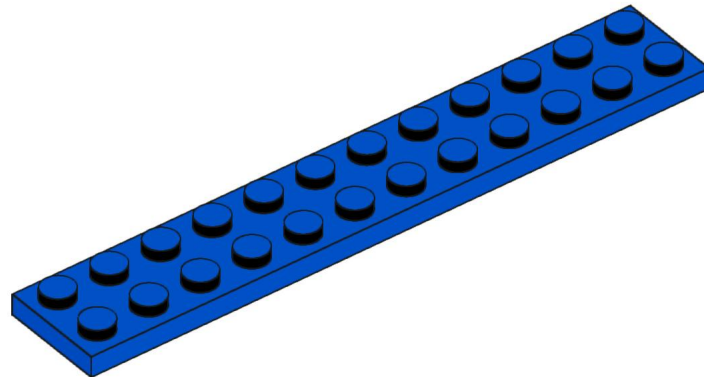

1x
2445, 7

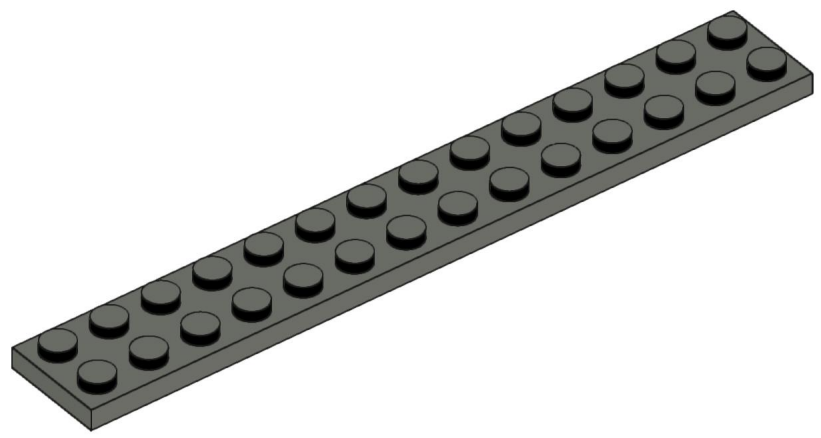

2x
91988, 85



1x
30153, 17



1x
30153, 15



1x
30153, 19



1x
30153, 51



1x
30153, 12



1x
30153, 50

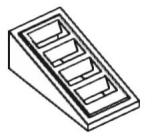

2x
61409, 1

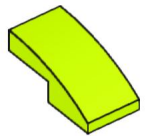

2x
11477, 34

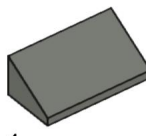

4x
85984, 85

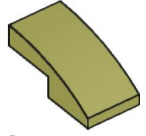

2x
11477, 155

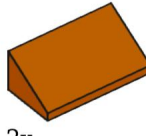

2x
85984, 68

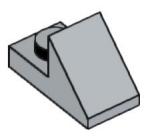

1x
92946, 86

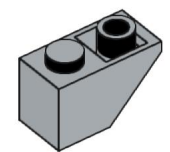

3x
3665, 86

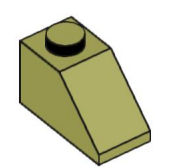

6x
3040, 155

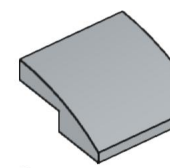

6x
15068, 86

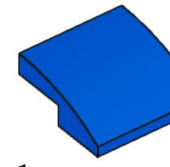

1x
15068, 7

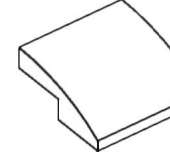

1x
15068, 1

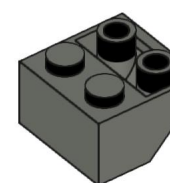

4x
3660, 85

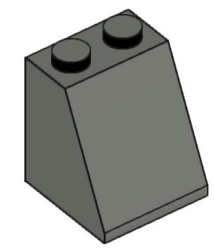

1x
3678b, 85

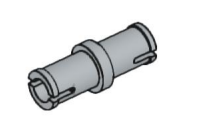

2x
3673, 86



3x
2780, 11

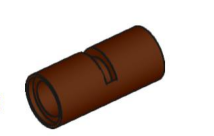

1x
62462, 88

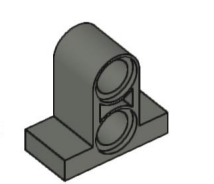

2x
32530, 85

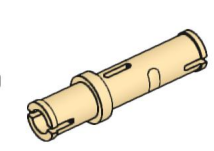

4x
32556, 2



2x
25269, 11

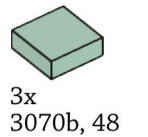

3x
3070b, 48

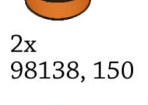

2x
98138, 150

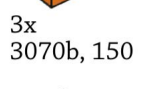

3x
3070b, 150

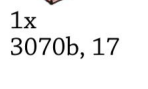

1x
3070b, 17

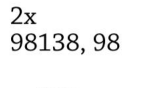

2x
98138, 98

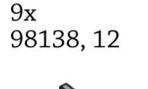

9x
98138, 12



6x
15712, 86



13x
15712, 11

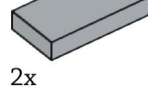

2x
3069b, 86

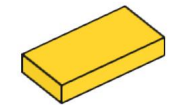

1x
3069b, 3

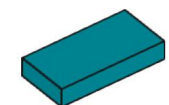

2x
3069b, 39

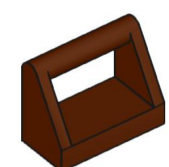

3x
2432, 88

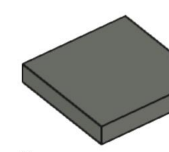

2x
3068b, 85

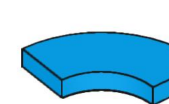

1x
27925, 153



2x
3068b, 7

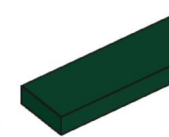

3x
63864, 80

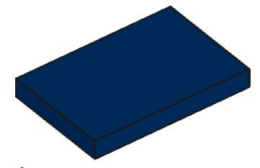

1x
26603, 63

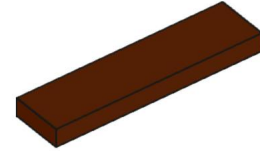

4x
2431, 88

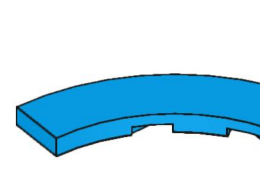

1x
27507, 153

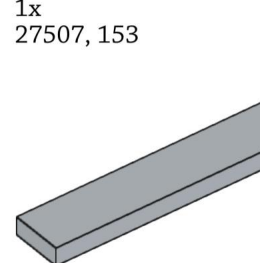

2x
6636, 86

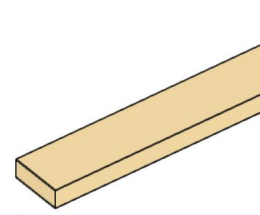

2x
6636, 2

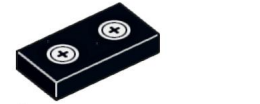

1x
3069bp02, 11



1x
3069bpb030, 85



4x
28326, 80

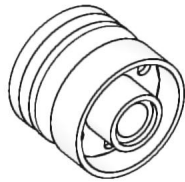

4x
55981, 1

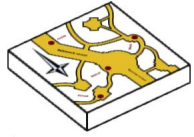

1x
3068bpb0059, 1

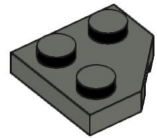

2x
26601, 85

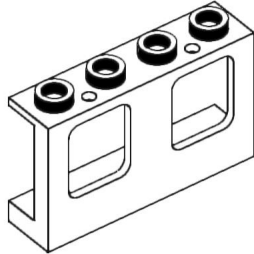

2x
61345, 1



2x
30028, 11

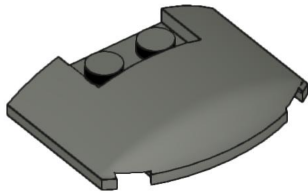

1x
93604, 85

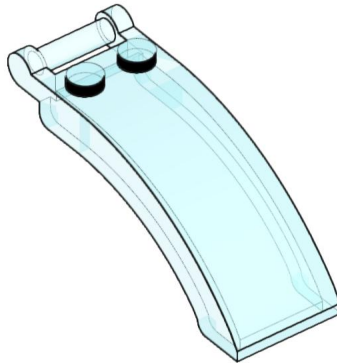

1x
92474, 15



4x
92402, 11

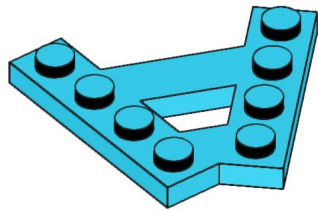

1x
3829c01, 7

1x
15706, 156



2x
74967, 86

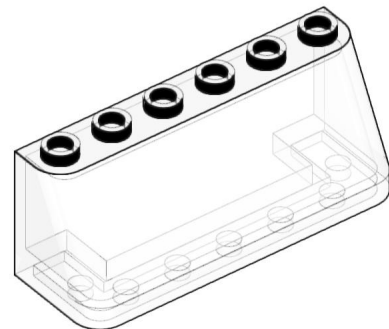

1x
4176, 12