

2

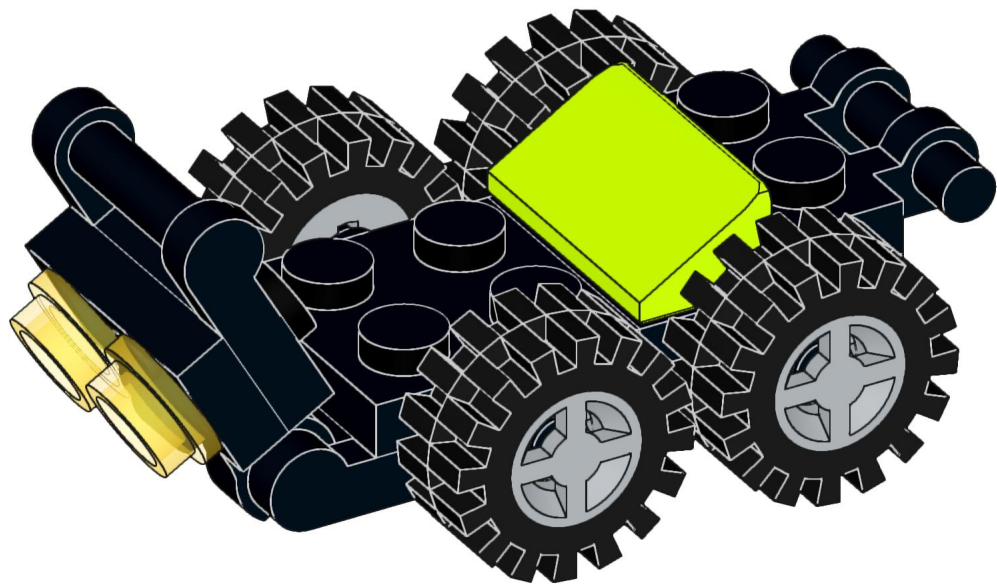

3

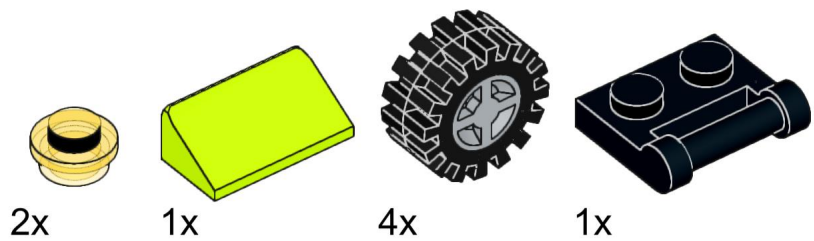

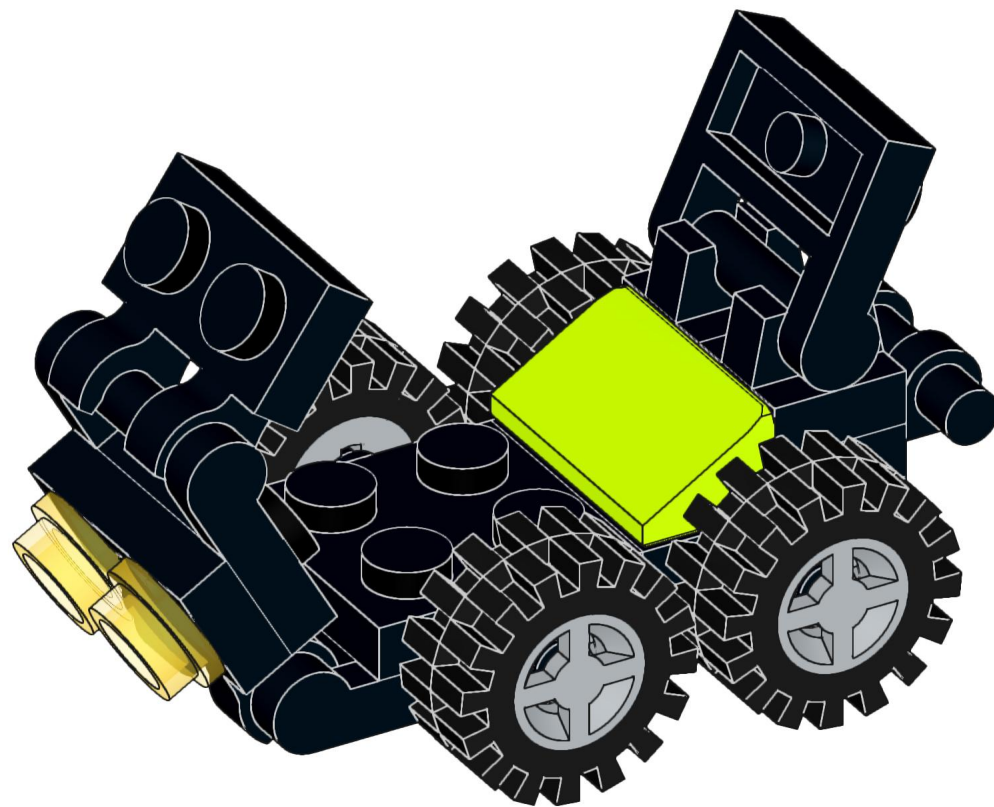
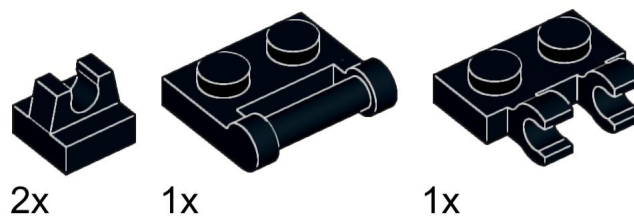
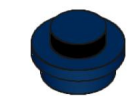

2x

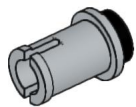

2x

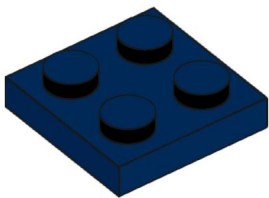

1x

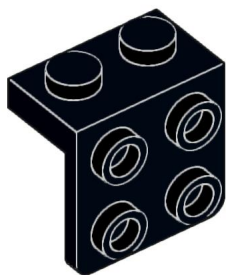

1x

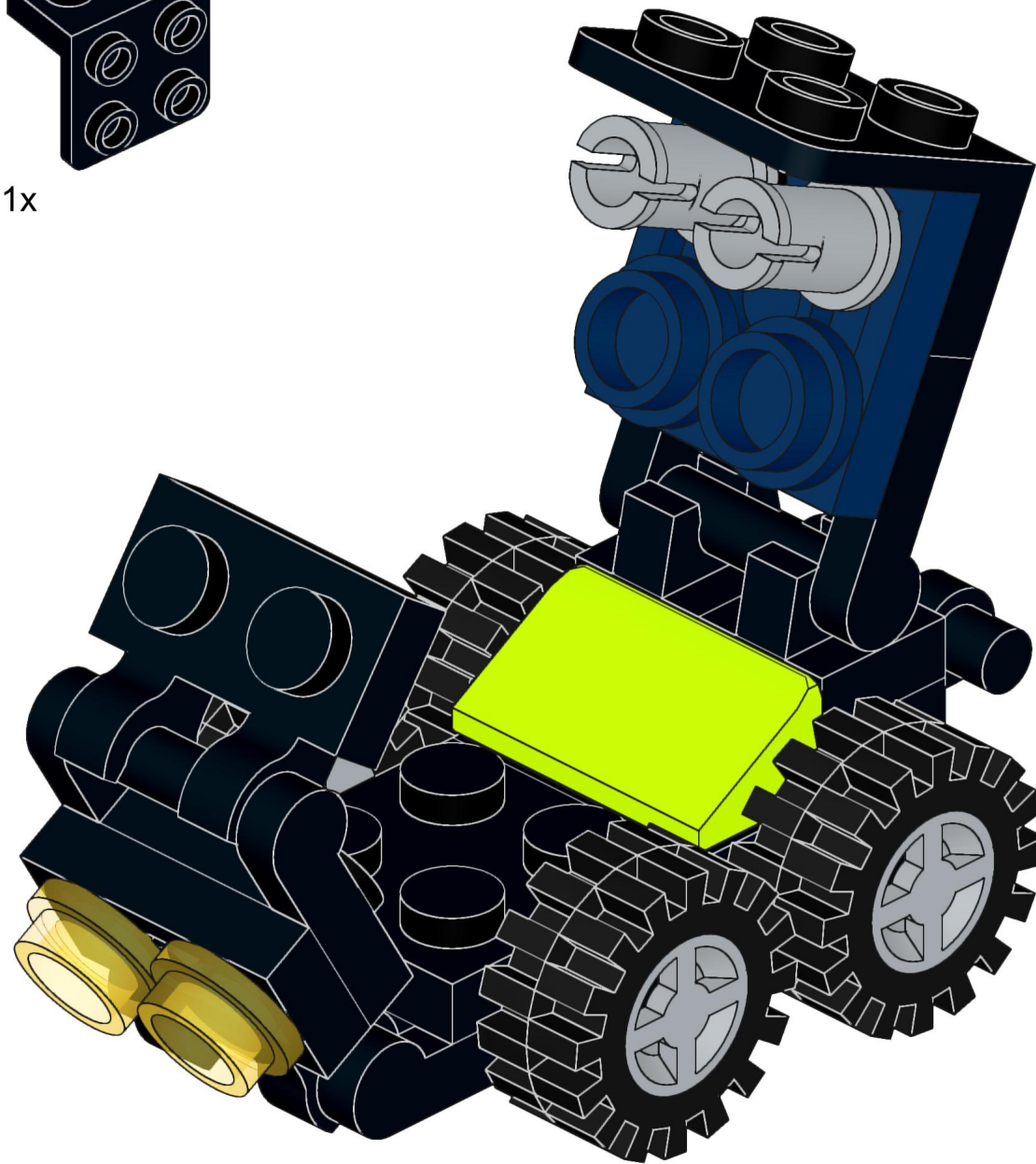

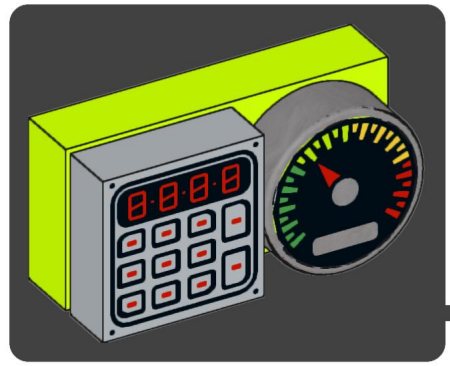
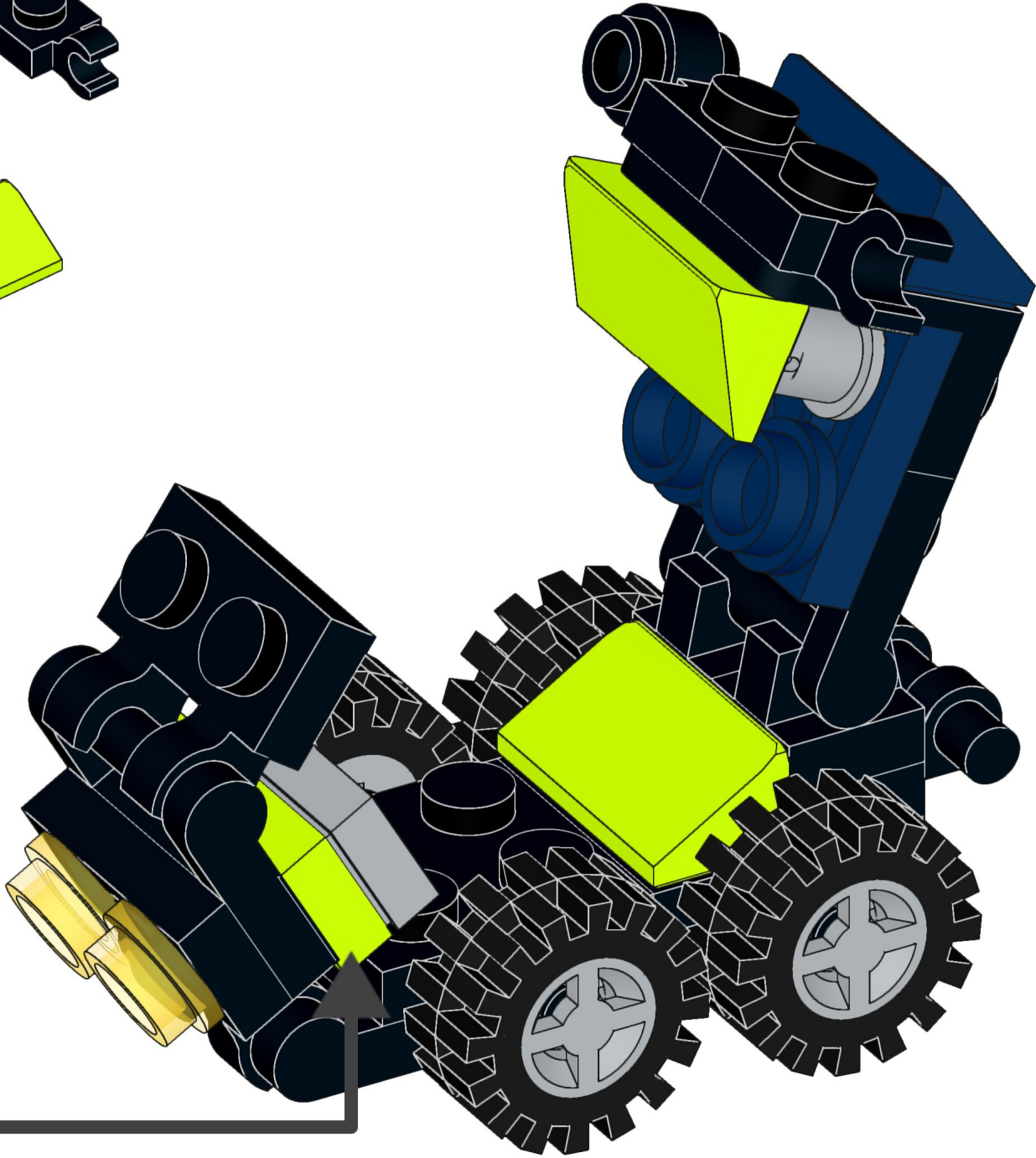
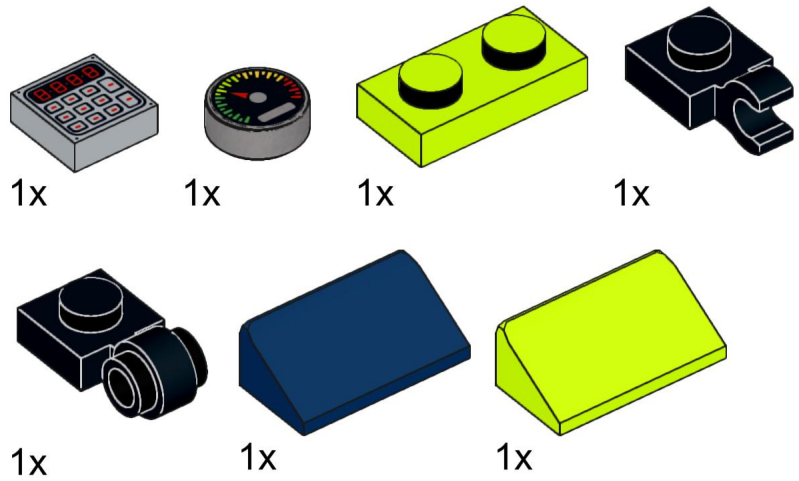

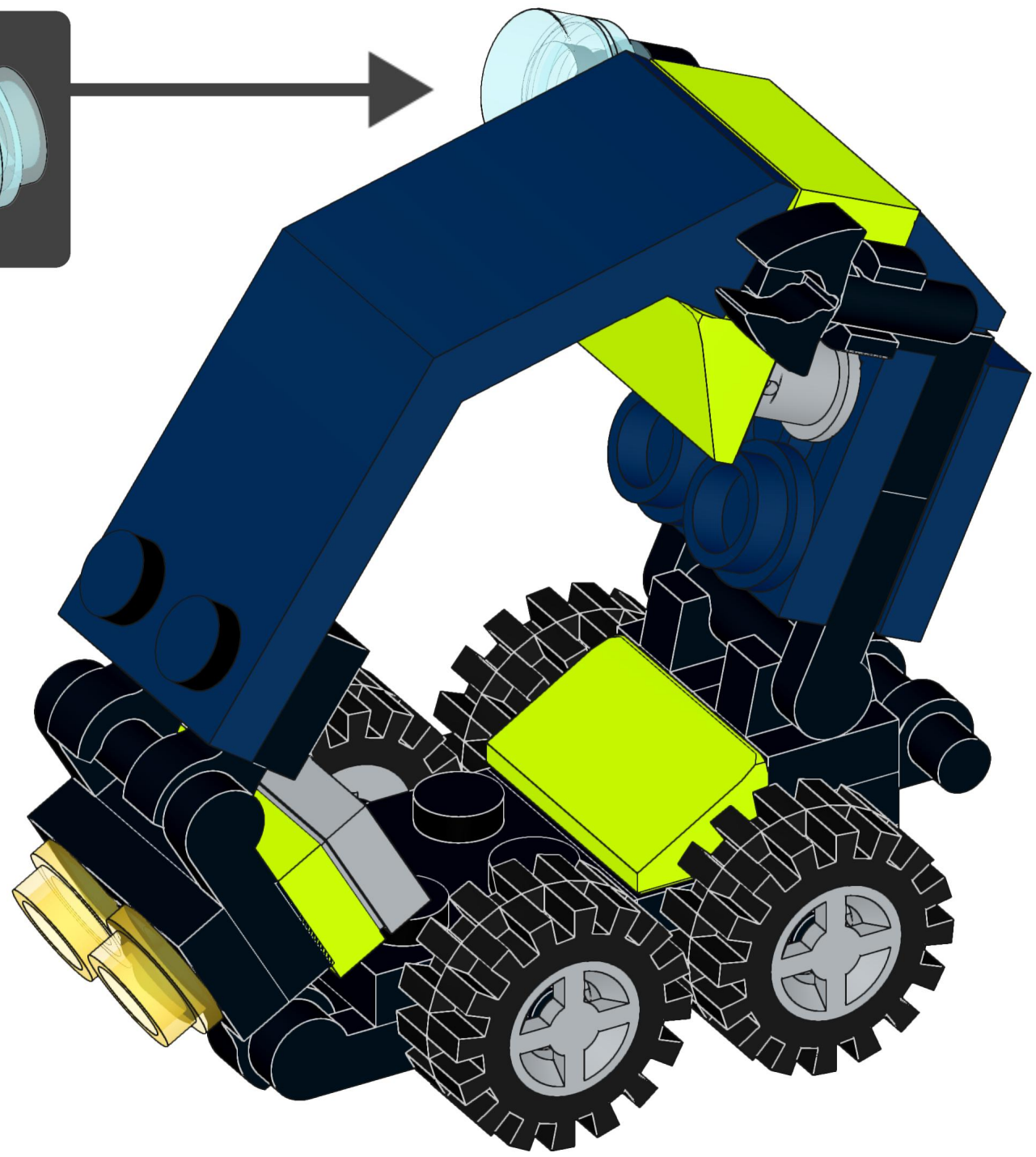
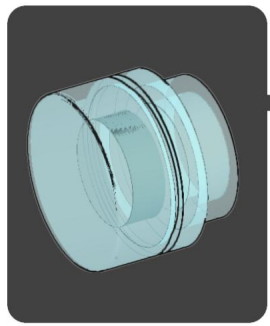
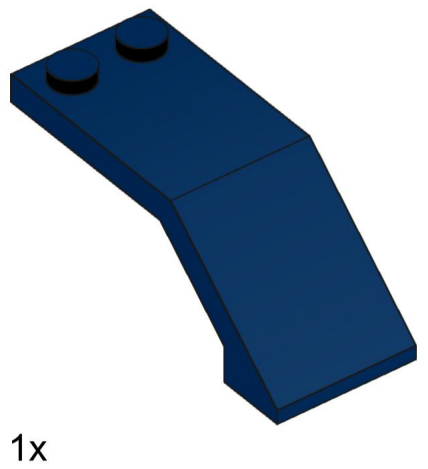
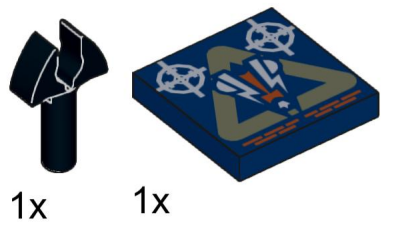
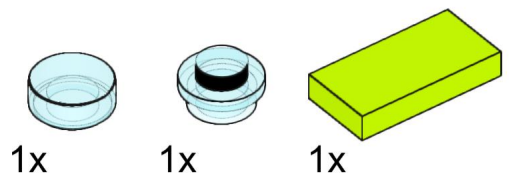

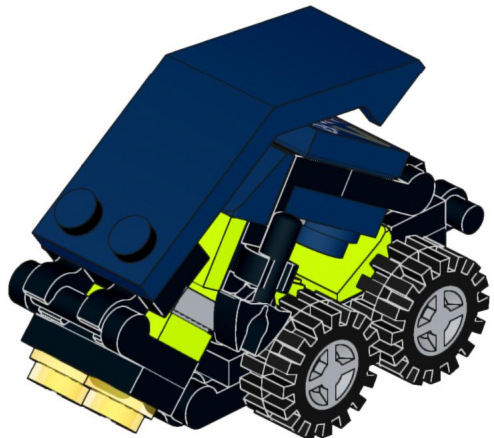
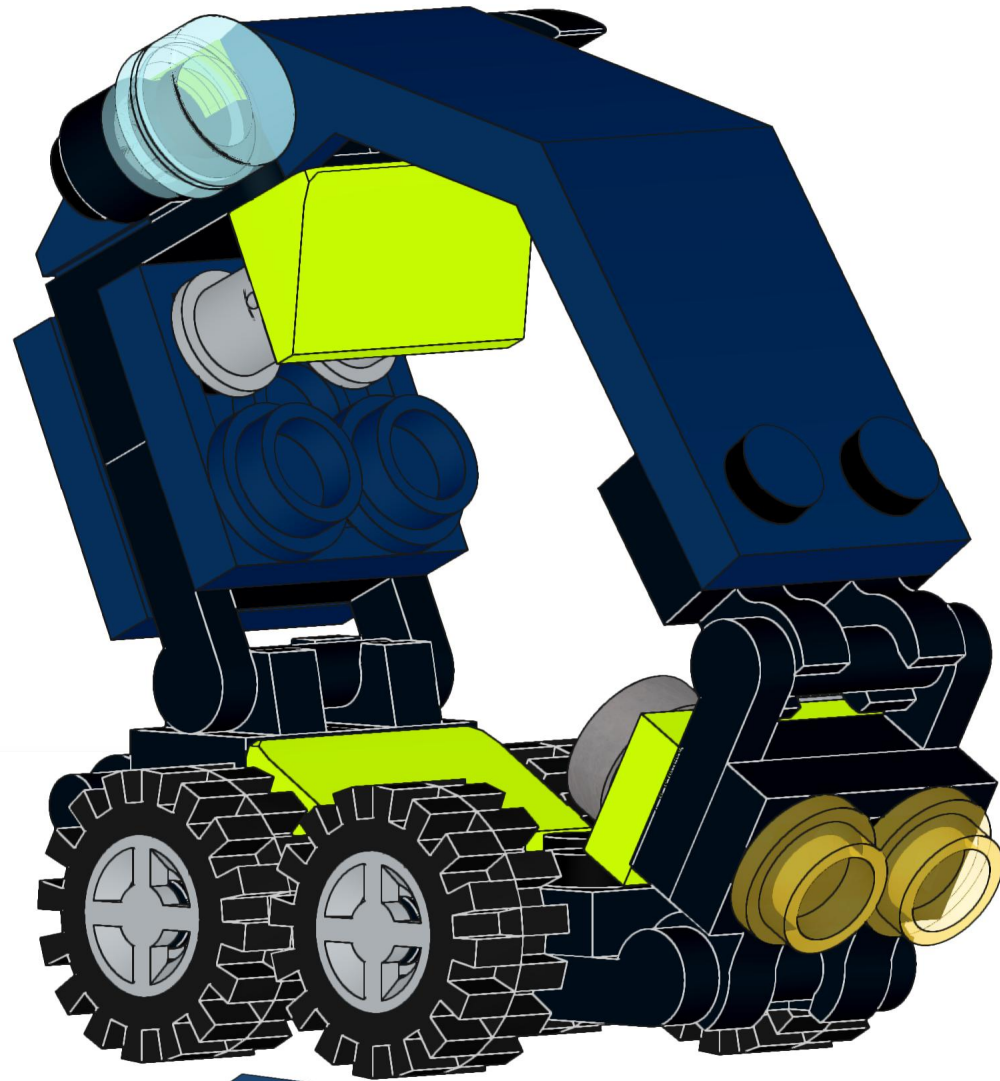
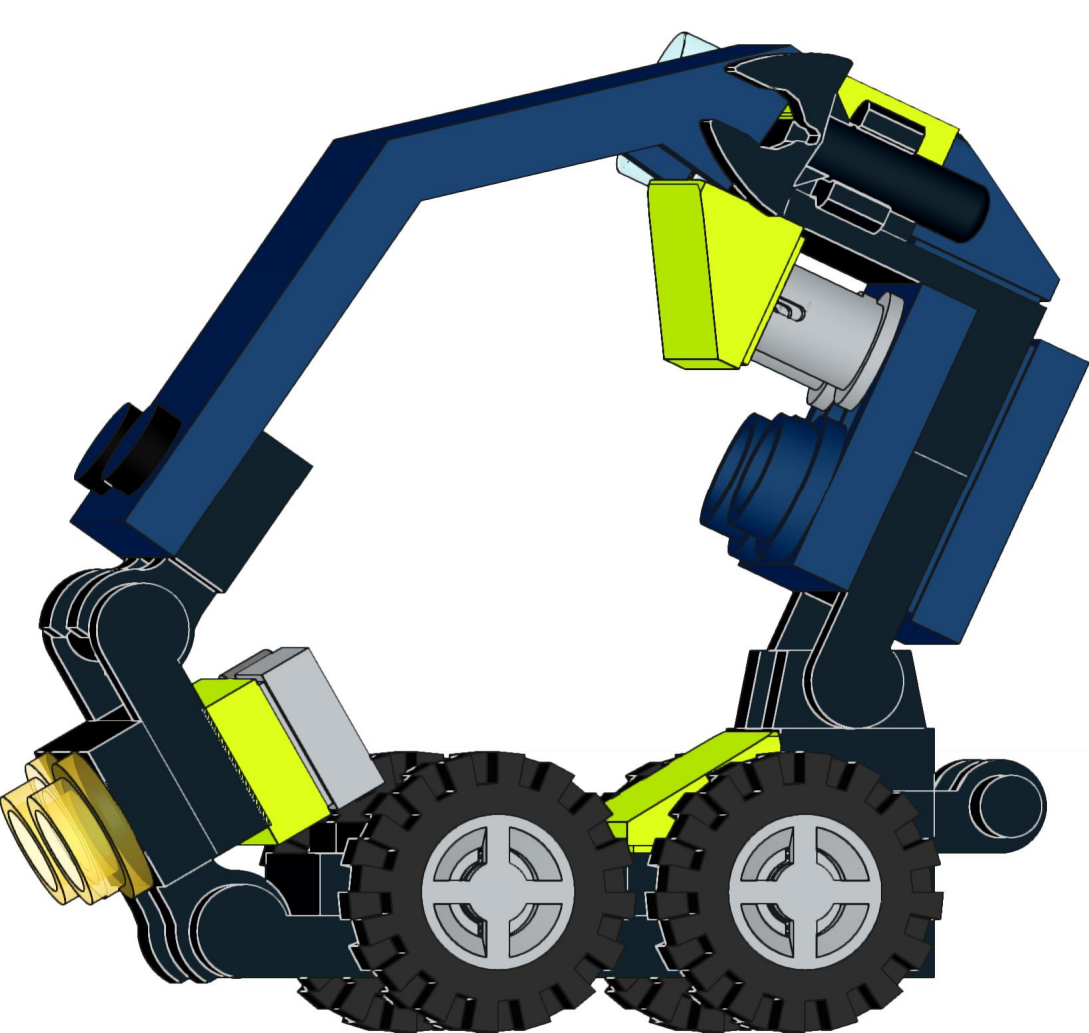







1x
48729, 11

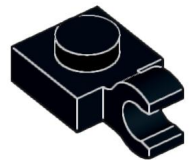

1x
61252, 11

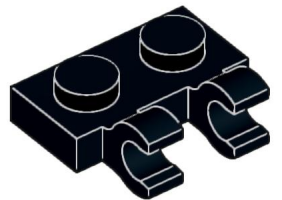

2x
60470b, 11

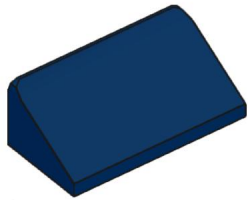

1x
85984, 63



1x
3070bpb089, 86

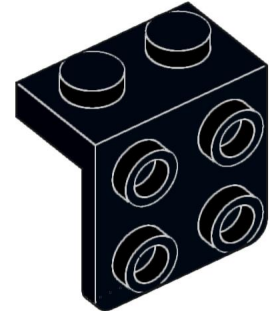

1x
44728, 11

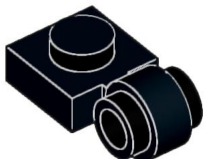

1x
4081b, 11

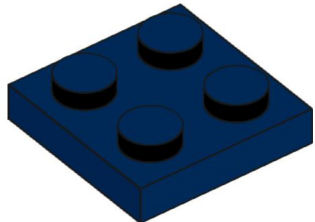

1x
3022, 63

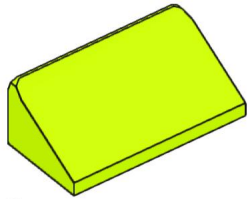

2x
85984, 34



1x
98138pb010, 95

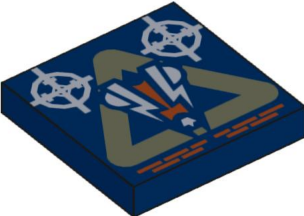

1x
6070, 63

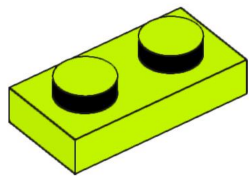

1x
3023, 34

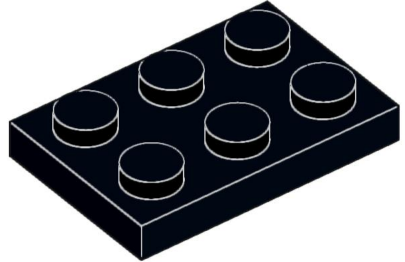

1x
3021, 11

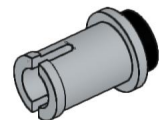

2x
4274, 86

1x
3068bpx7, 63

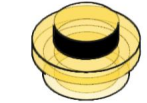

2x
4073, 19

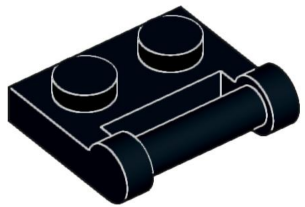

3x
48336, 11

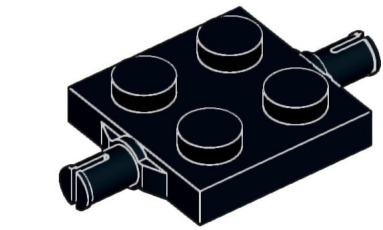

2x
4600, 11

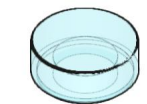

1x
98138, 15



4x
4624c02, 86

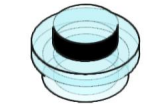

1x
4073, 15

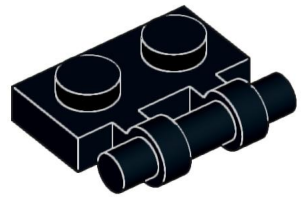

1x
2540, 11



2x
2555, 11

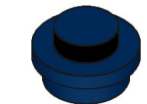

2x
4073, 63

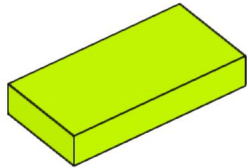

1x
3069b, 34

