

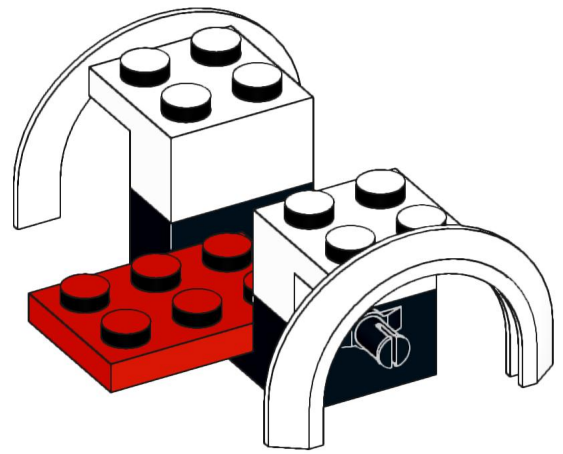

1

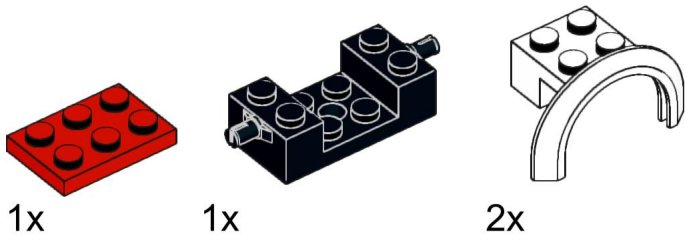

2

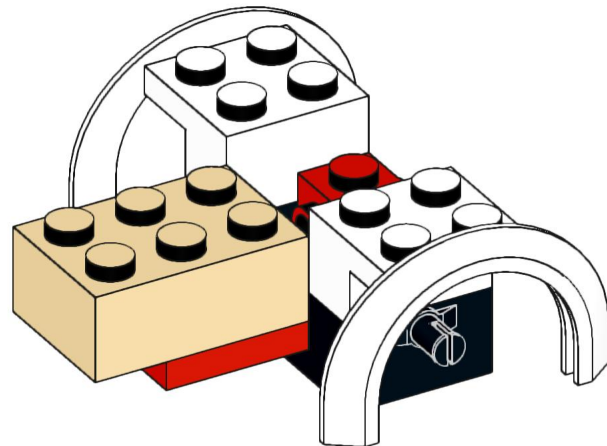
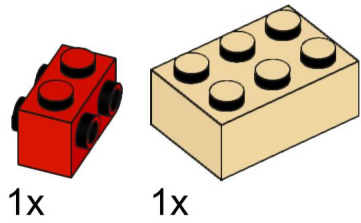

3

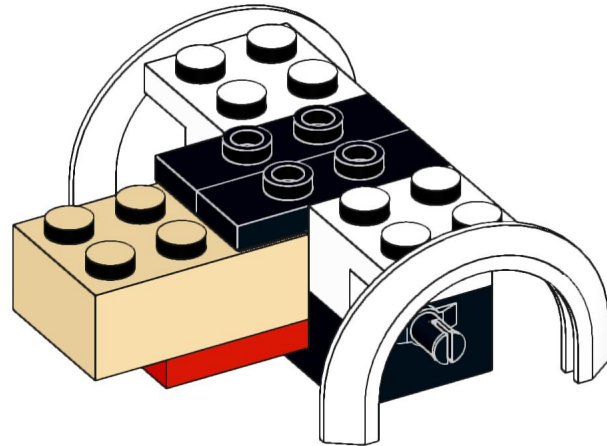
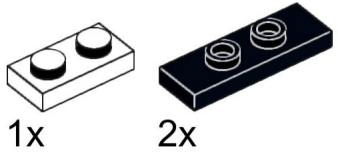

4

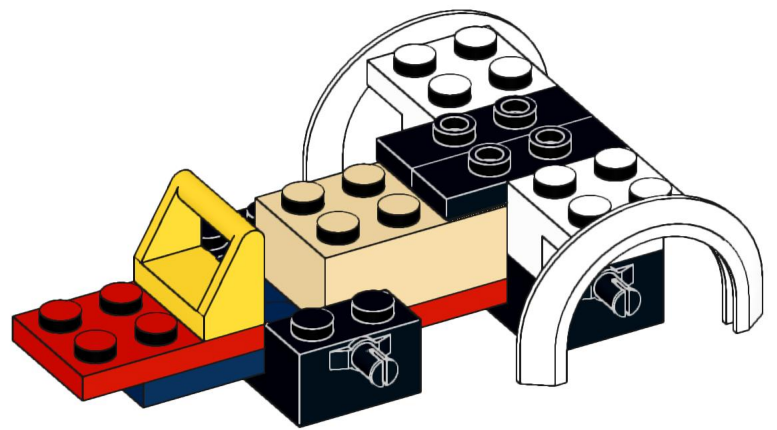
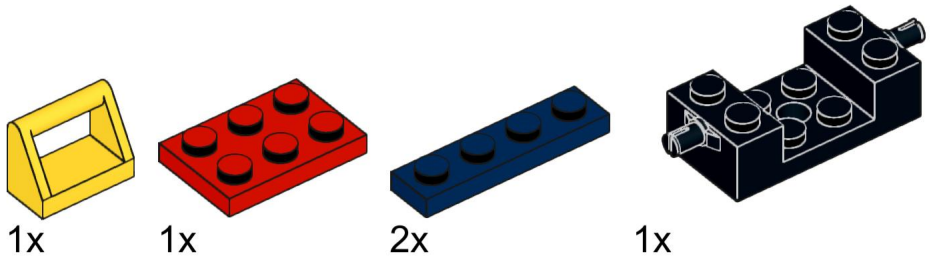

5

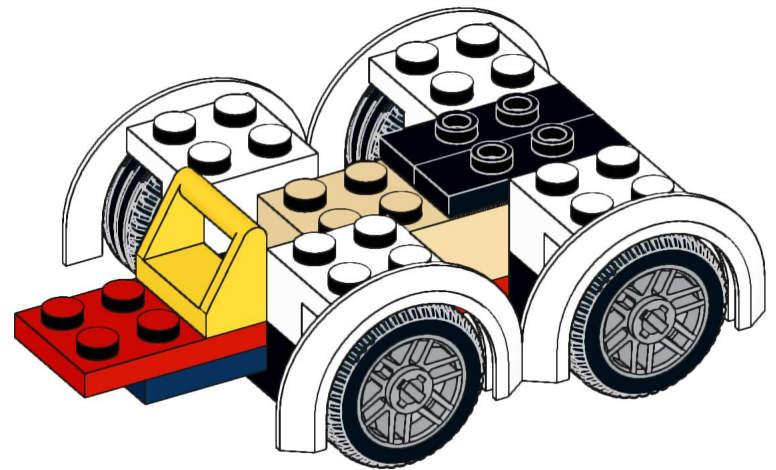
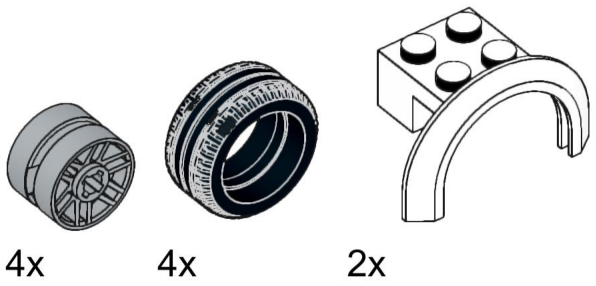

6

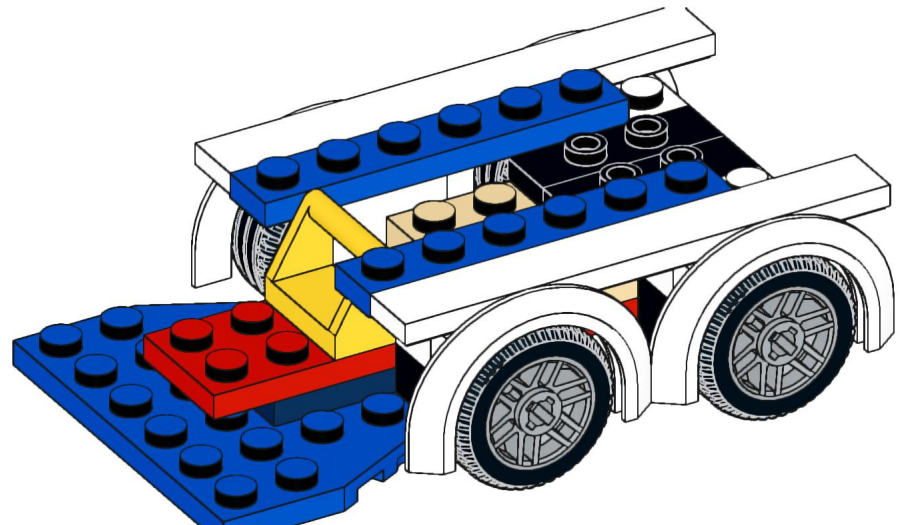
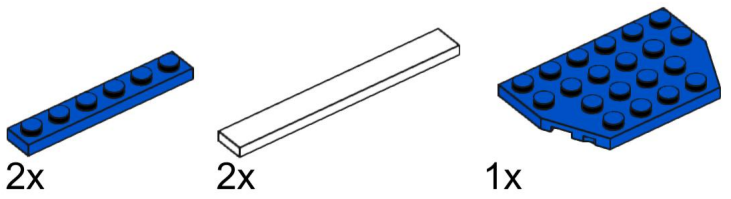

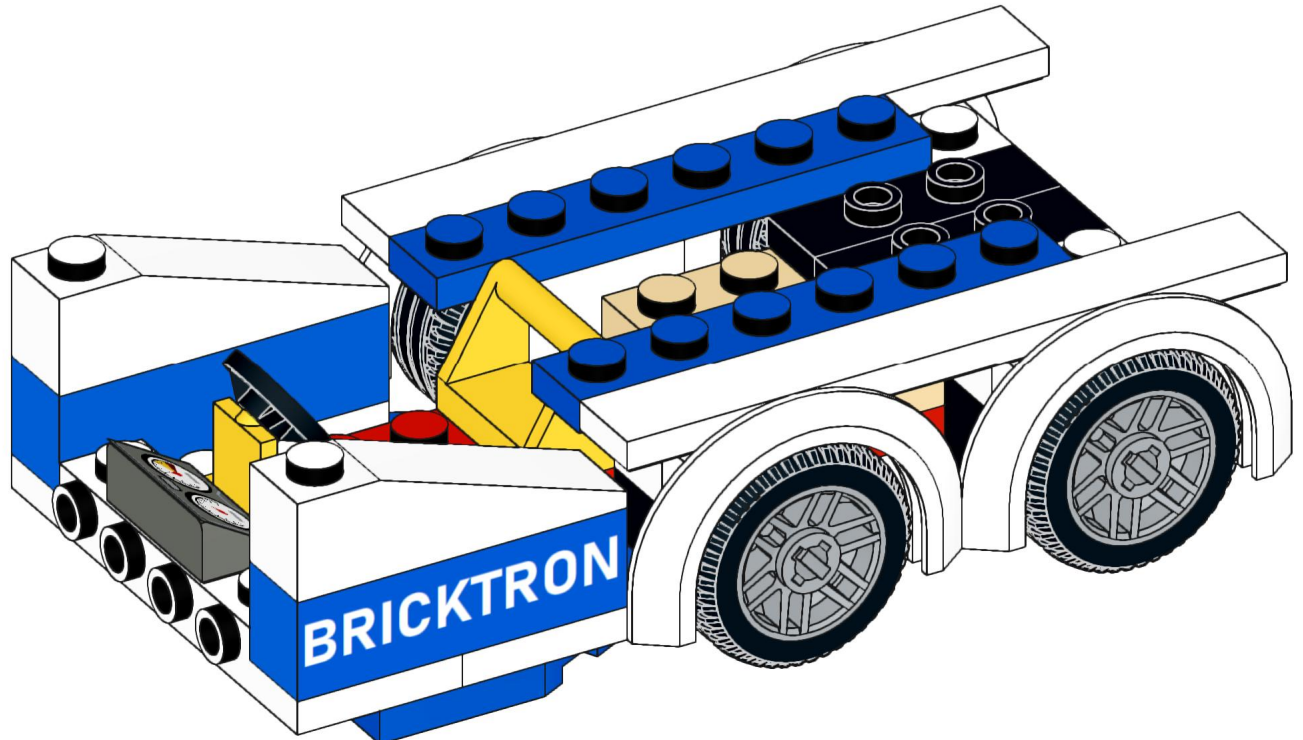
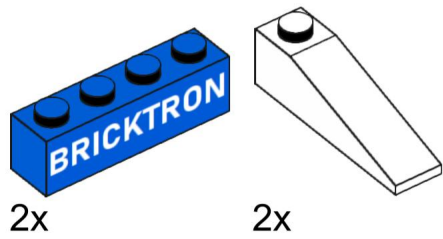
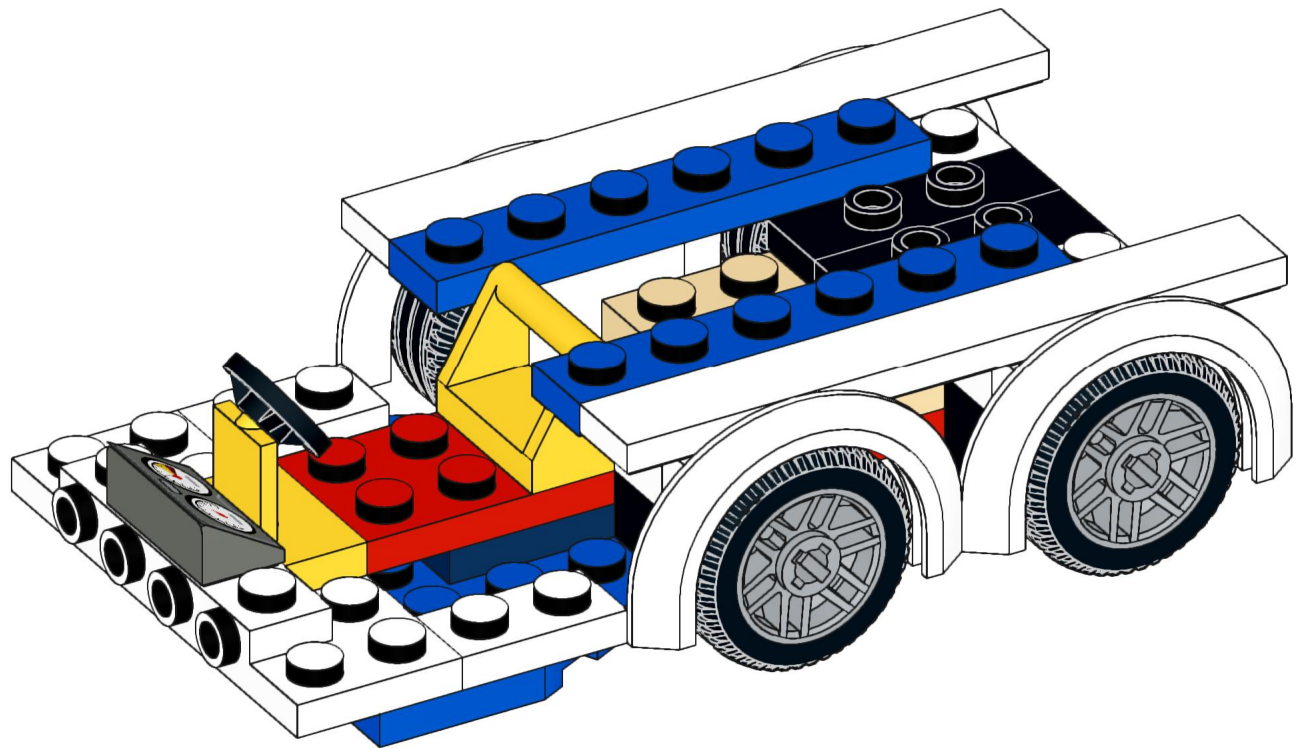
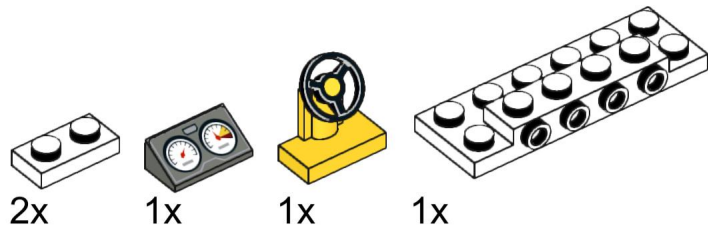

9

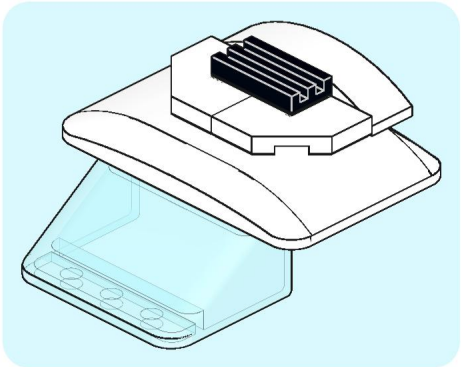
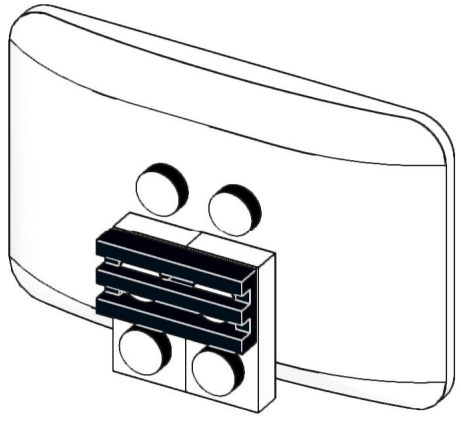
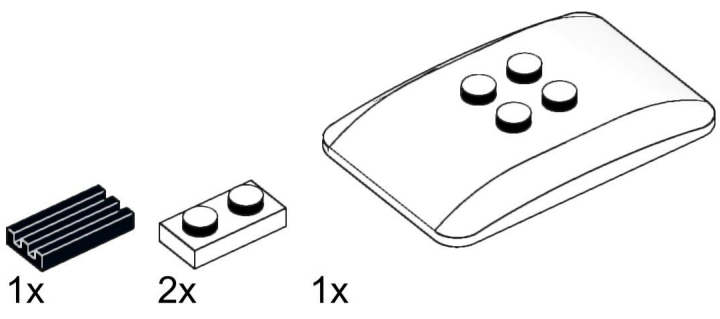

10

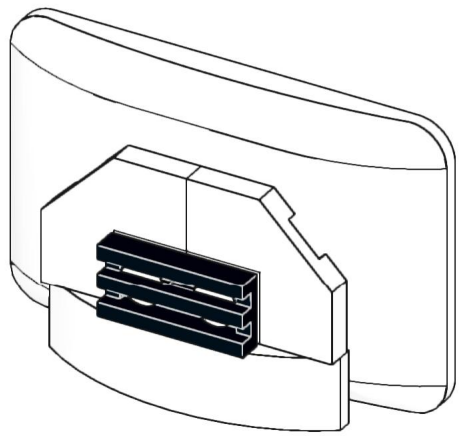
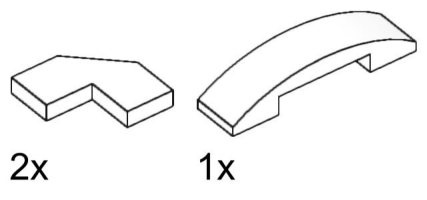

11

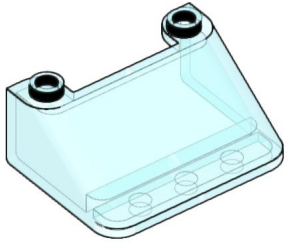

1x

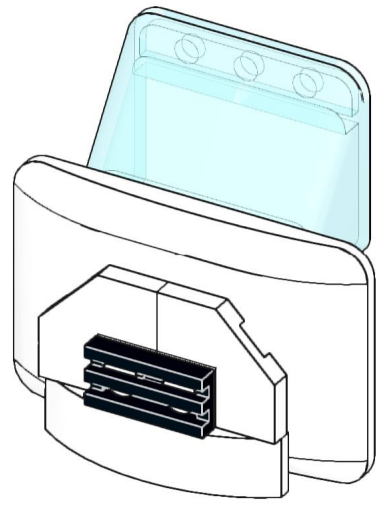

12

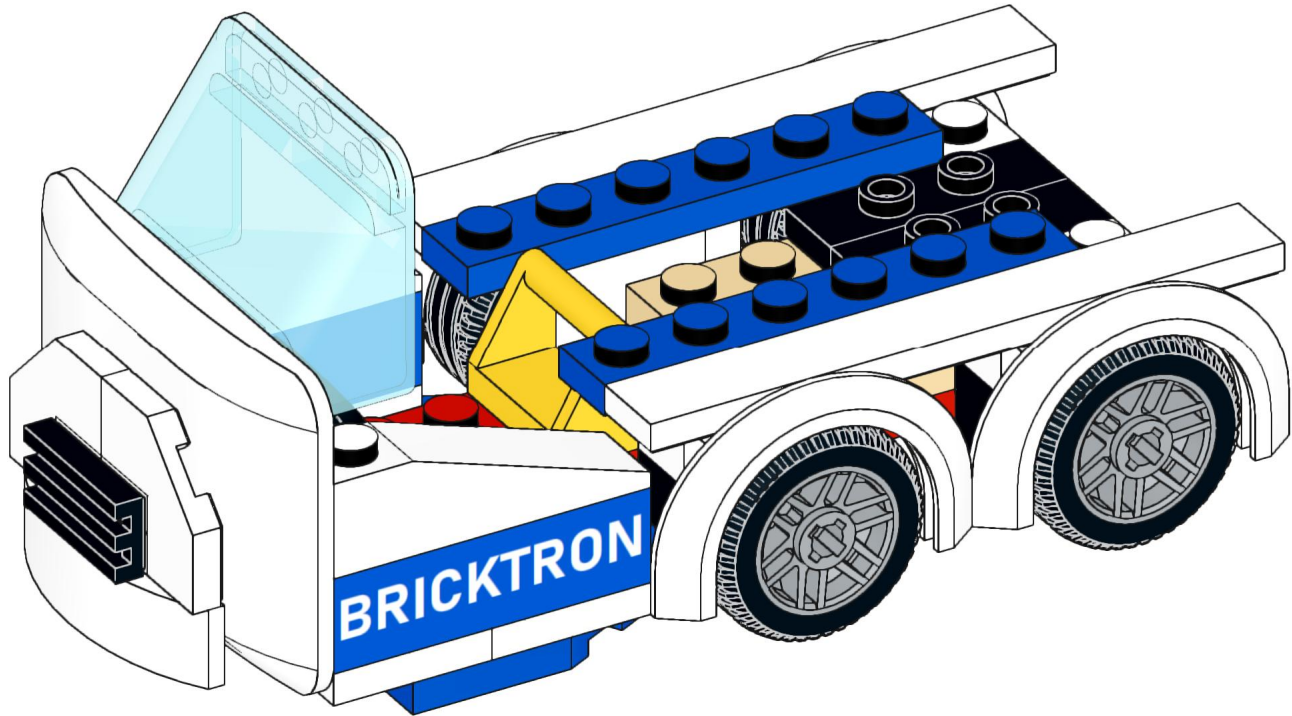

13

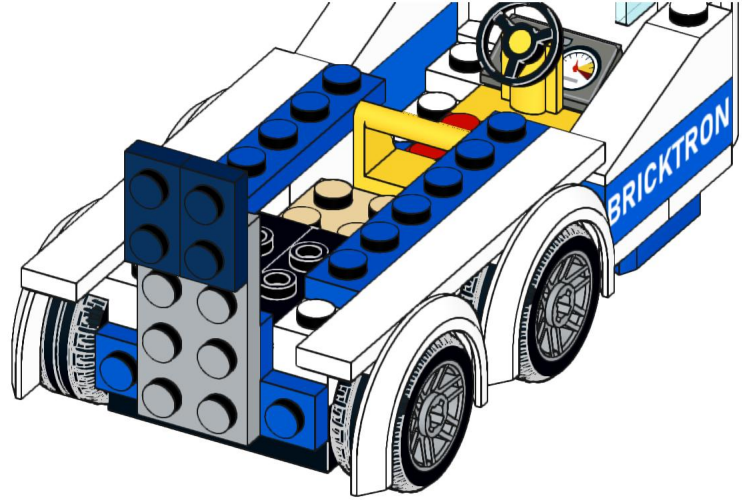
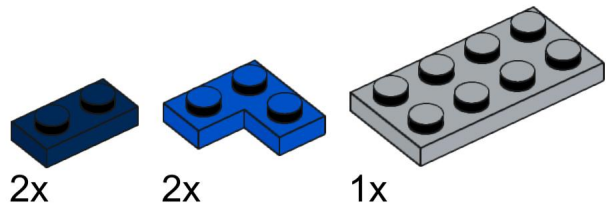

14

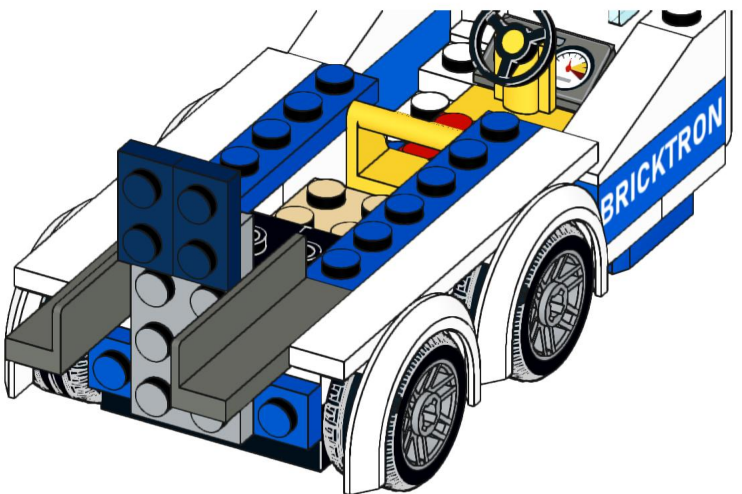
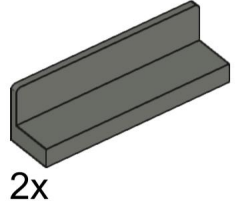

15

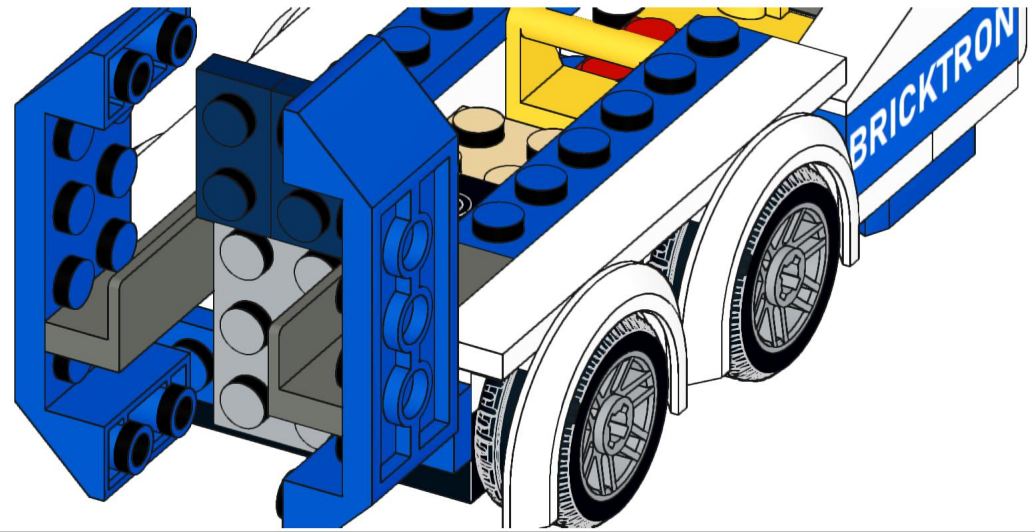
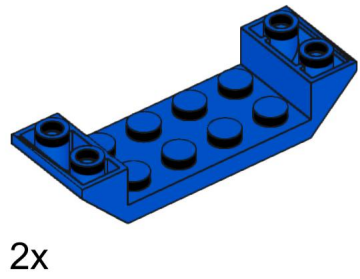

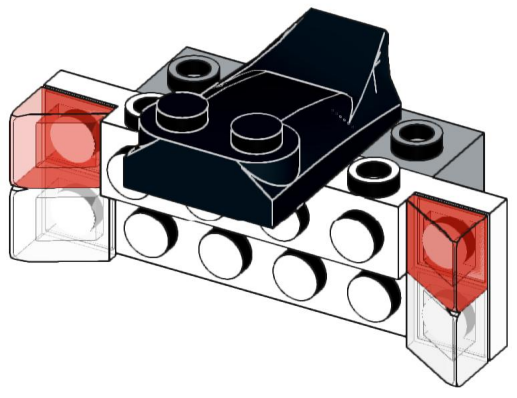
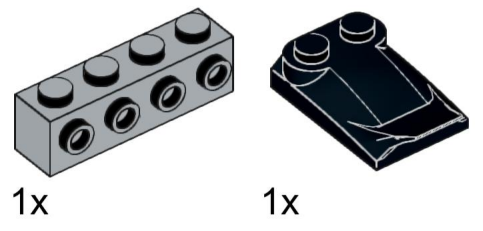
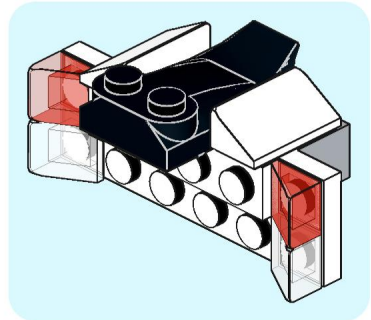
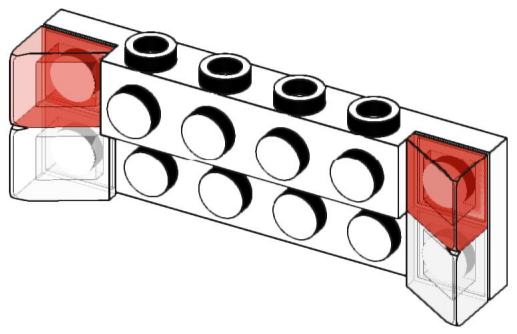
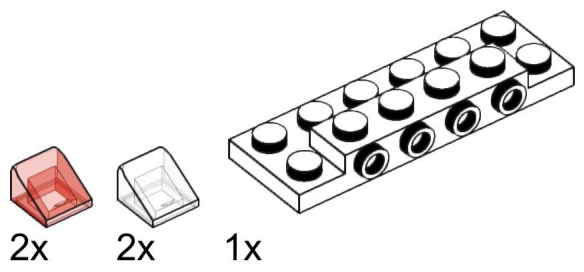

18



2x

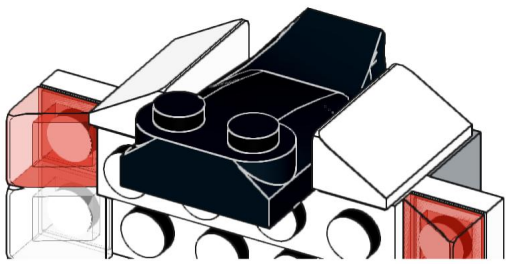

19

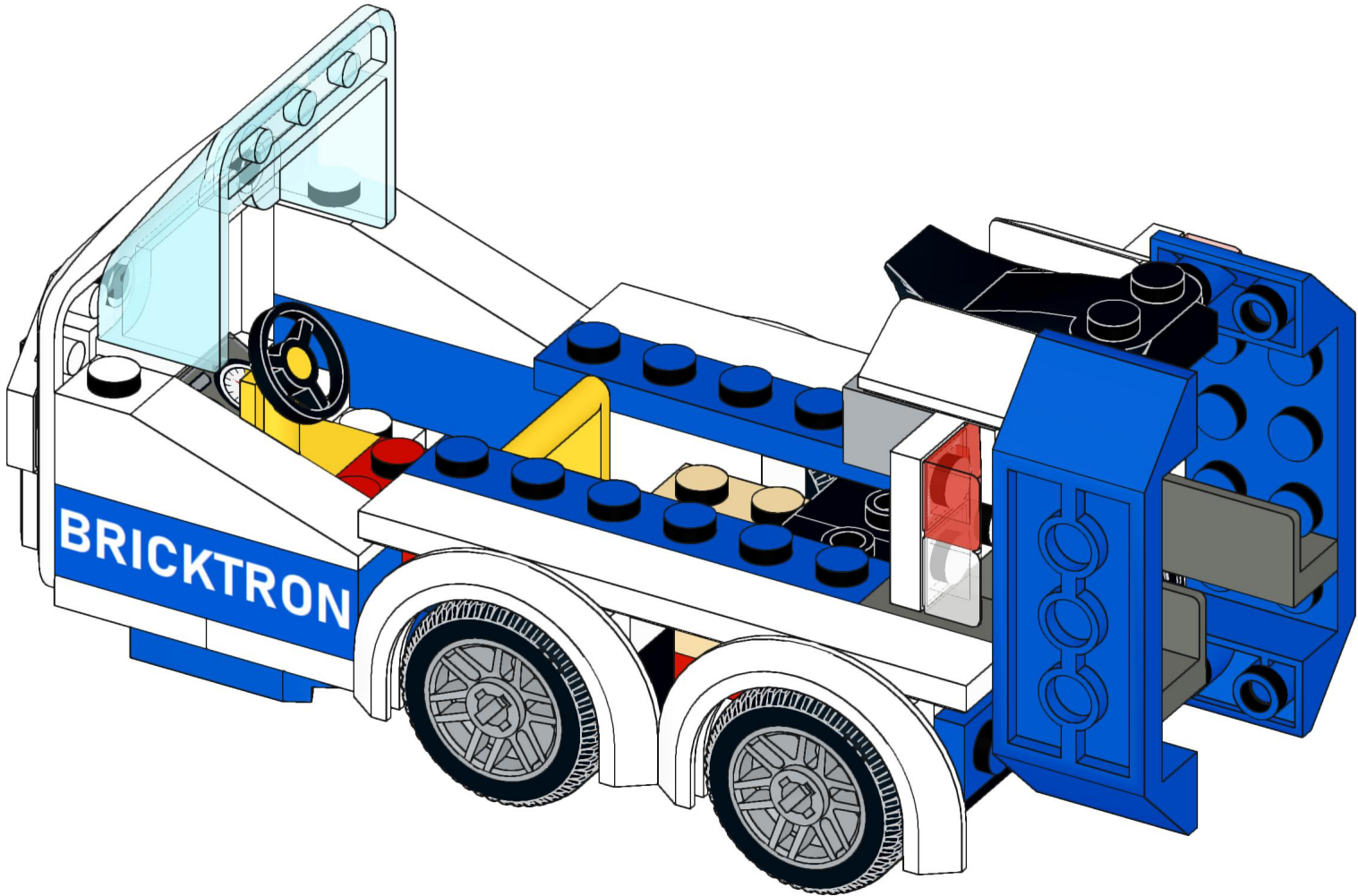

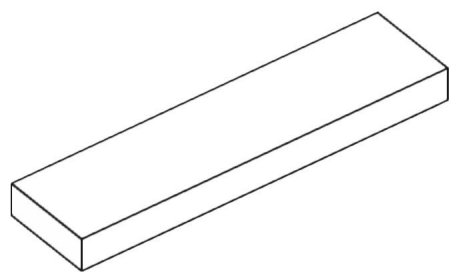

1x

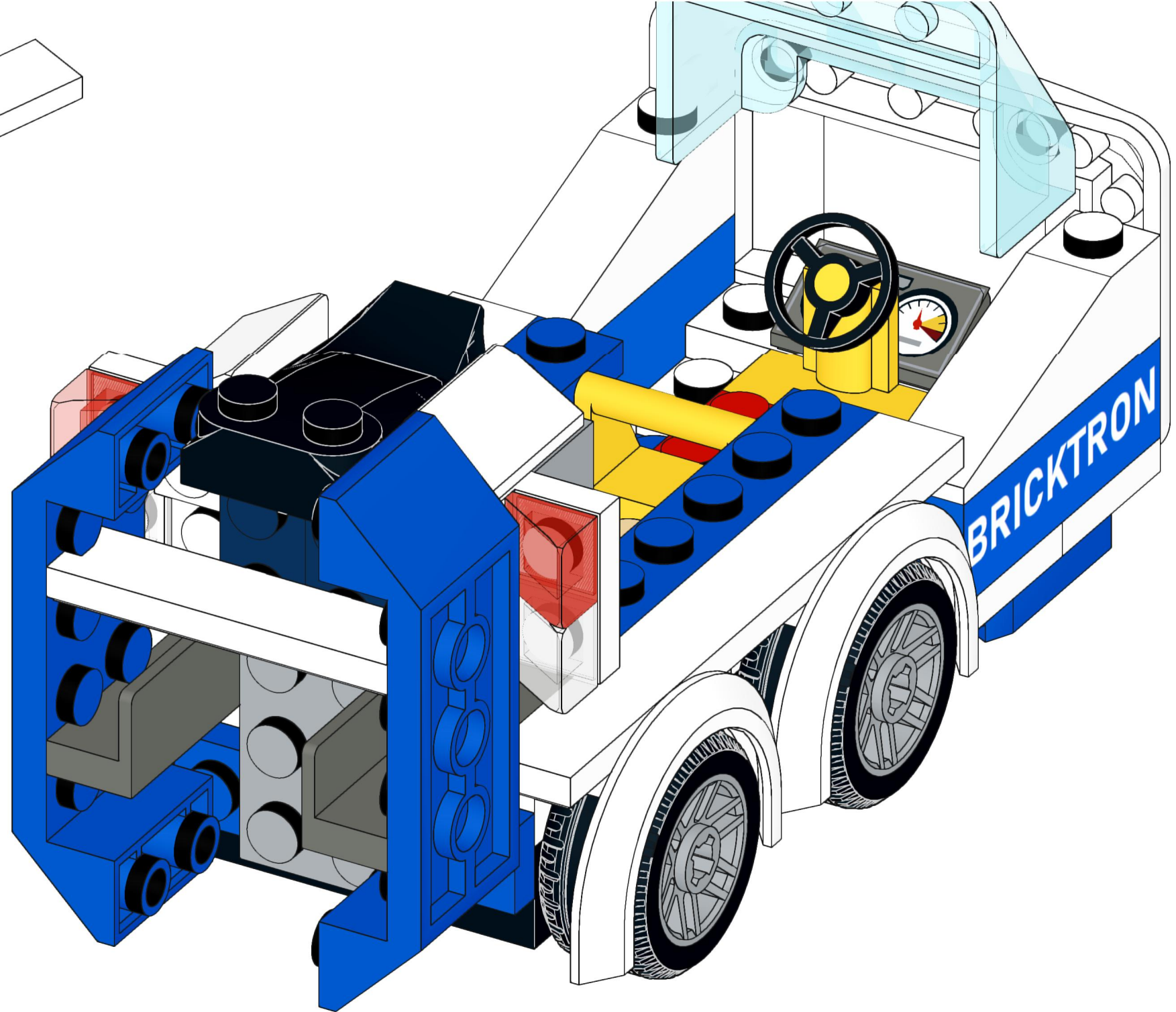

21

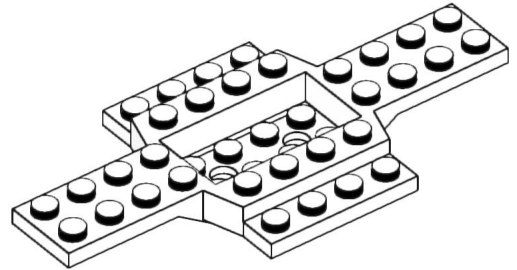
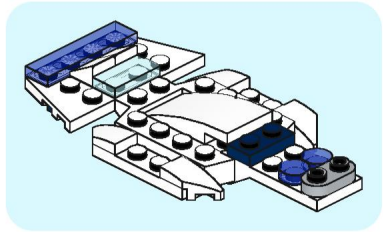
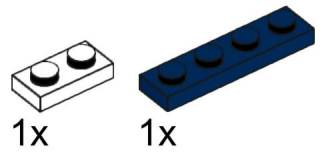

1x

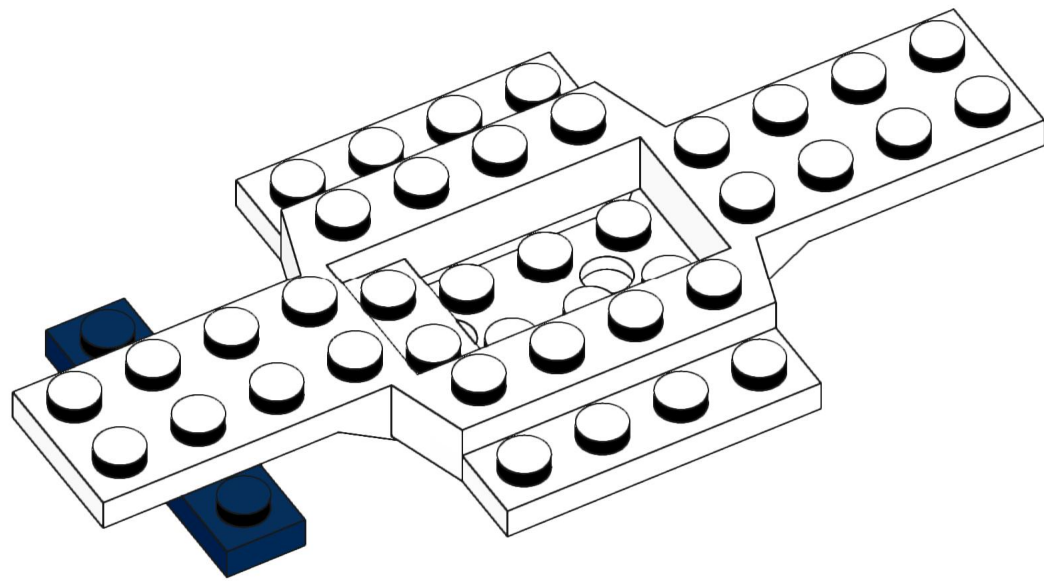

22

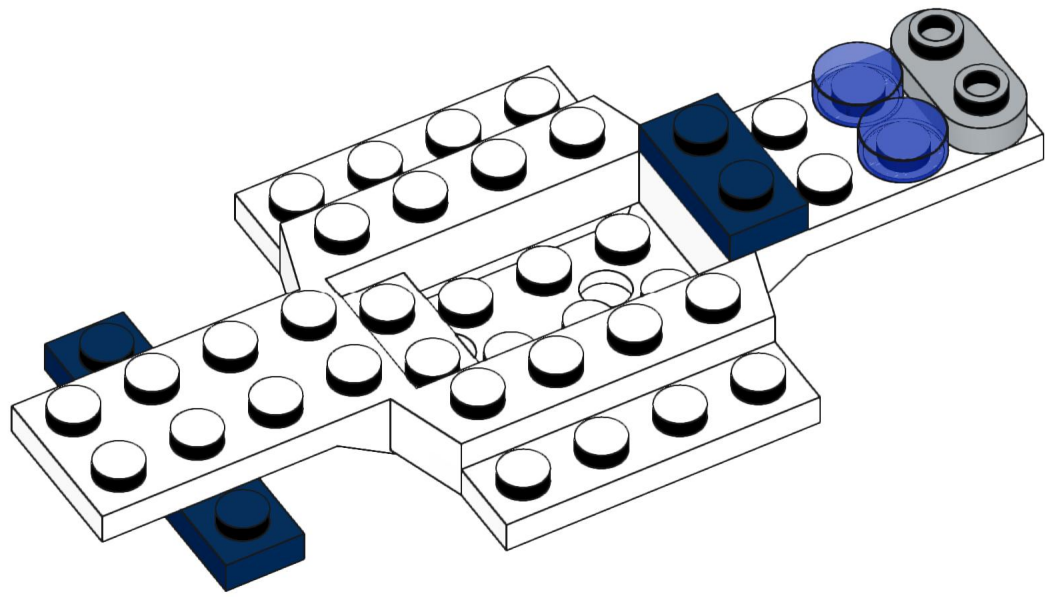
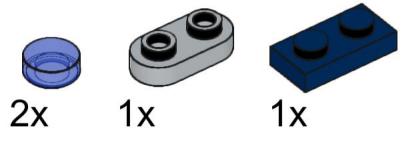

23

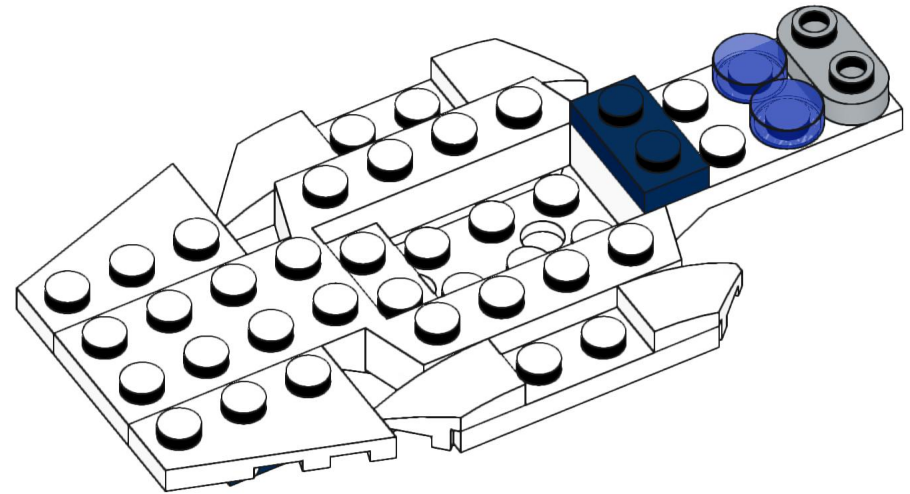
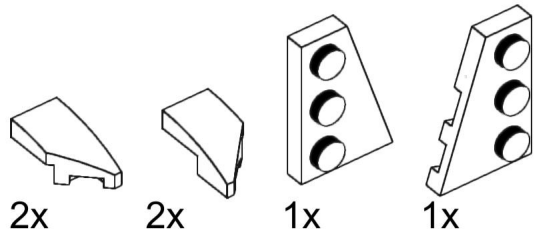

24

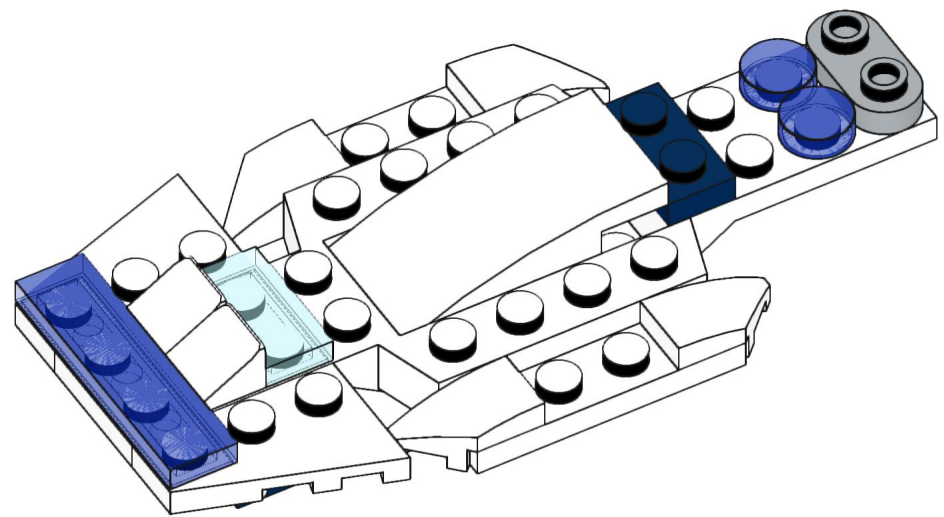
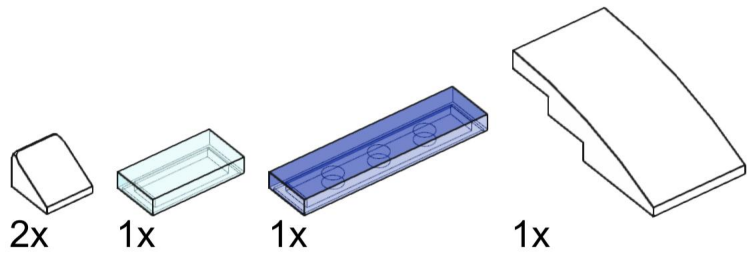

25

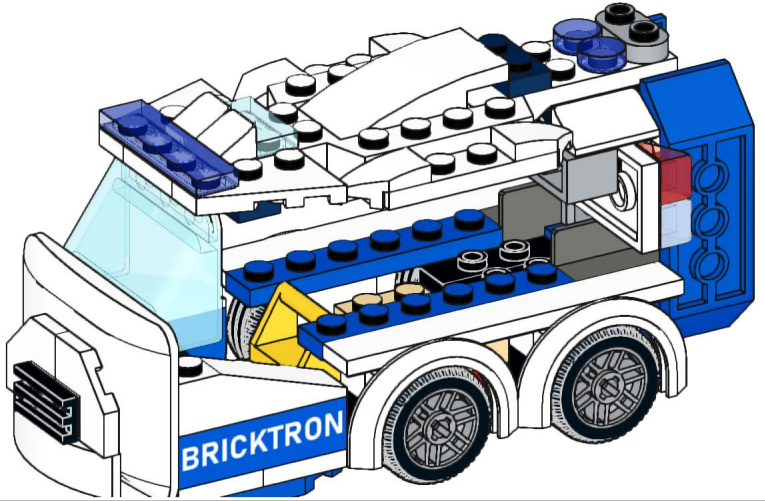

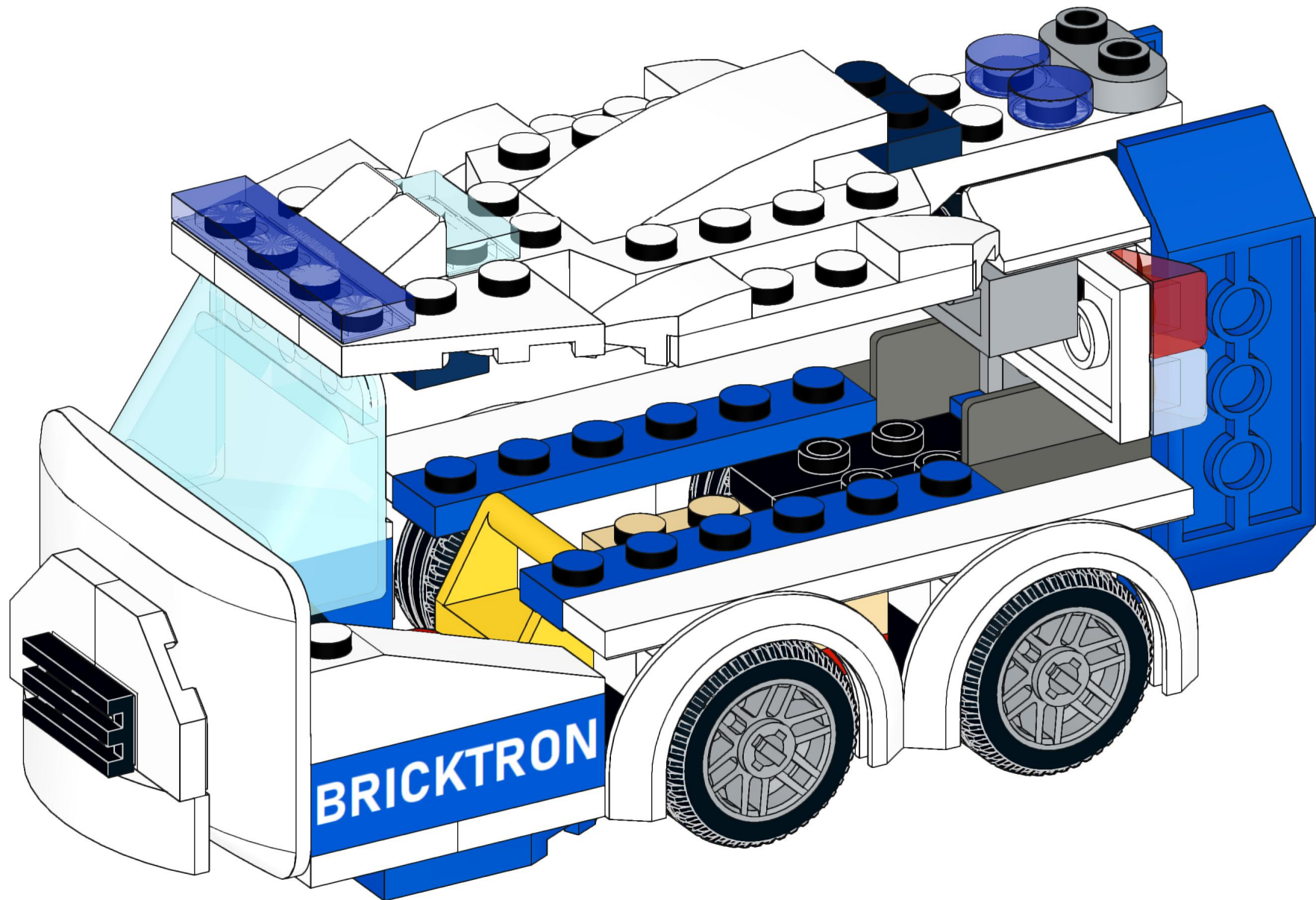

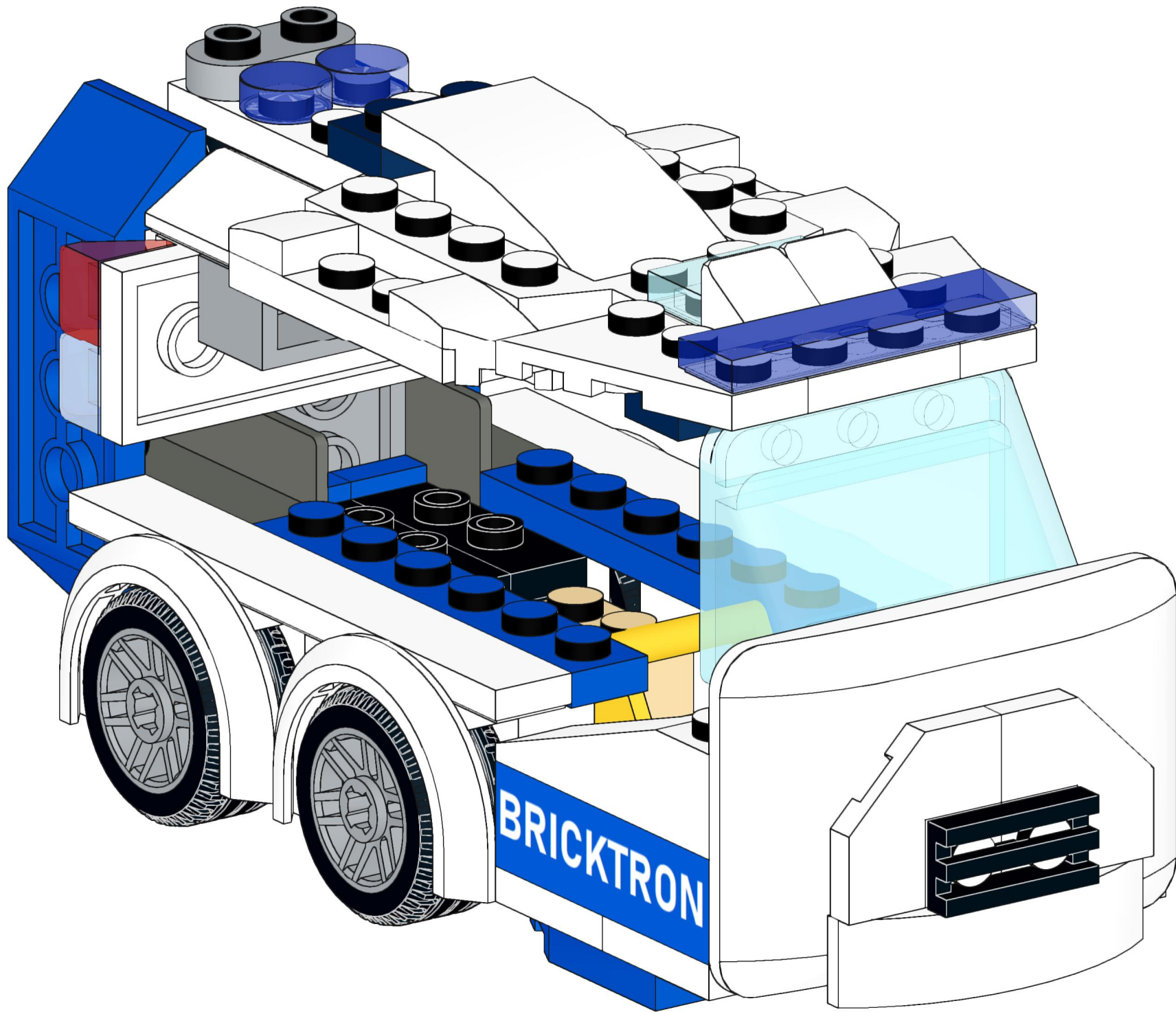

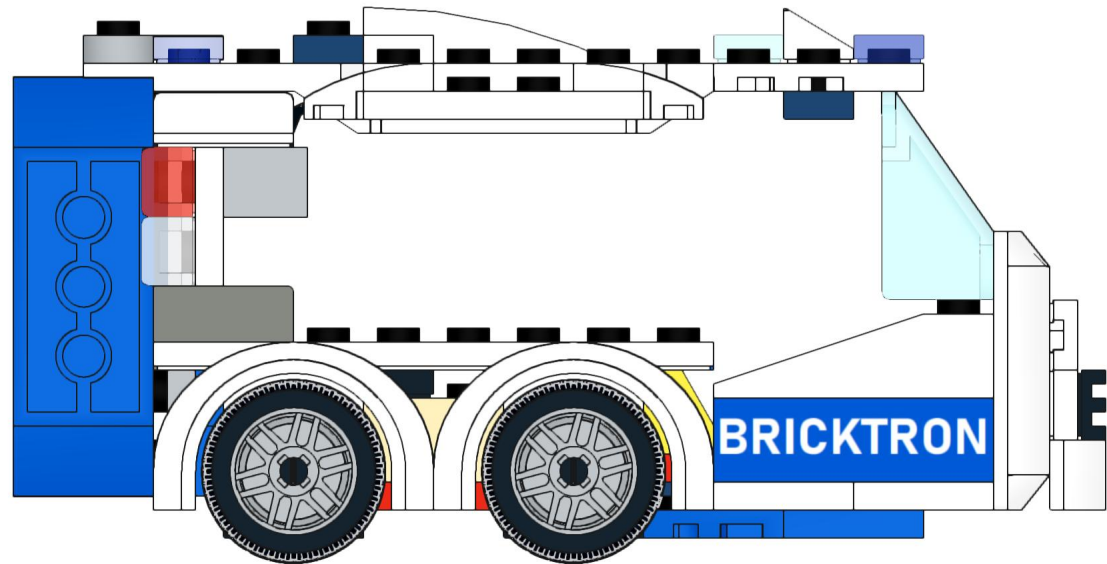
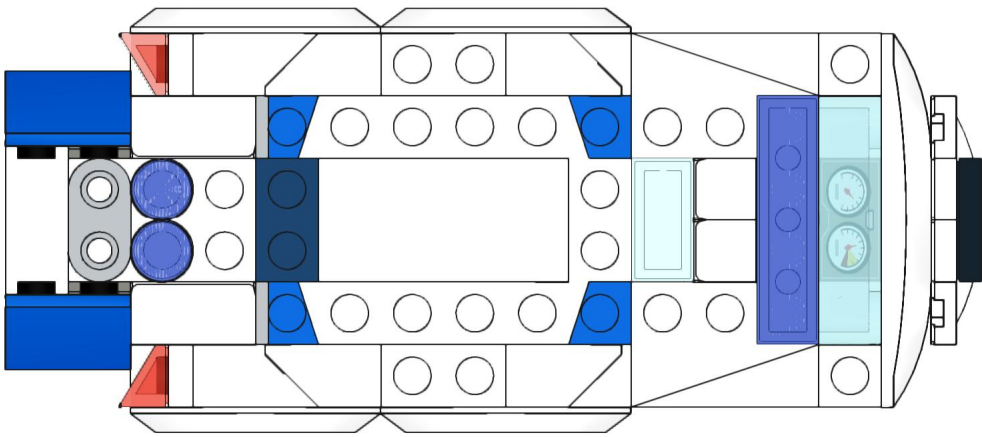
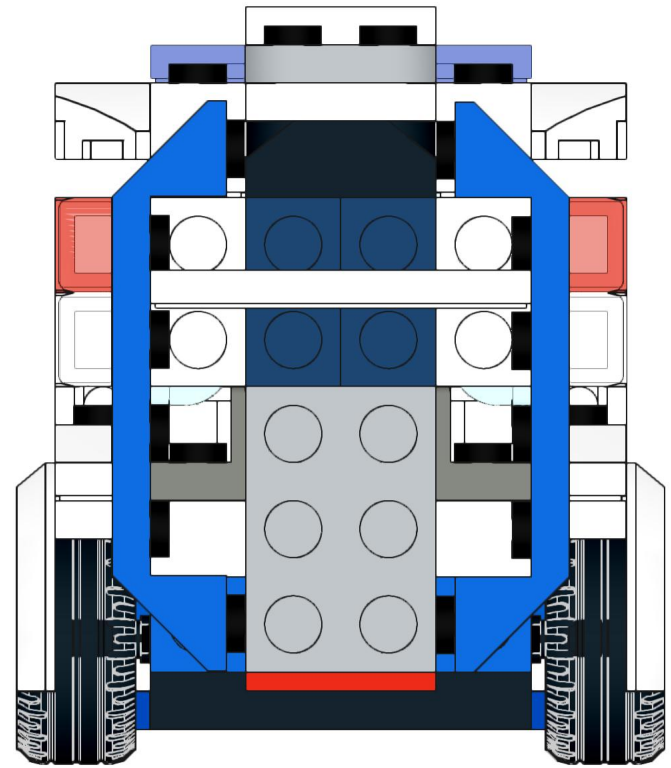
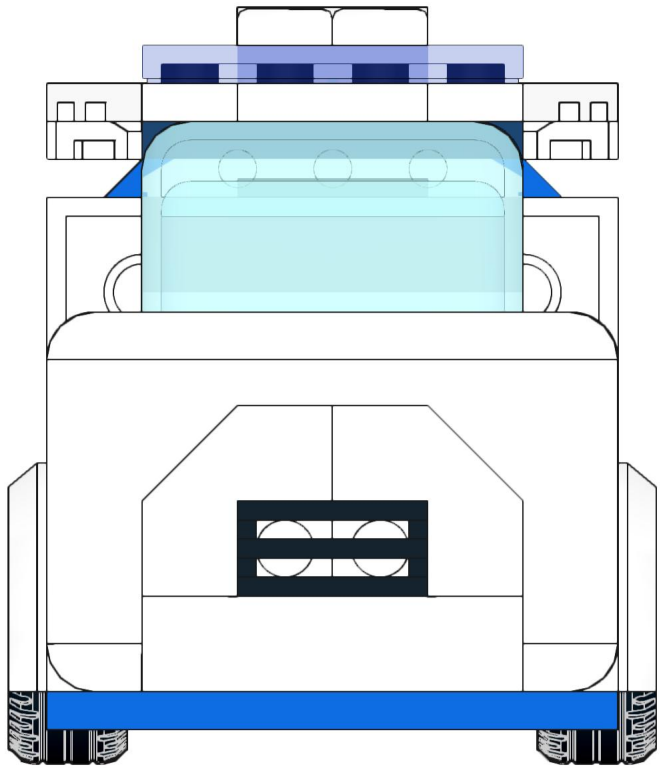

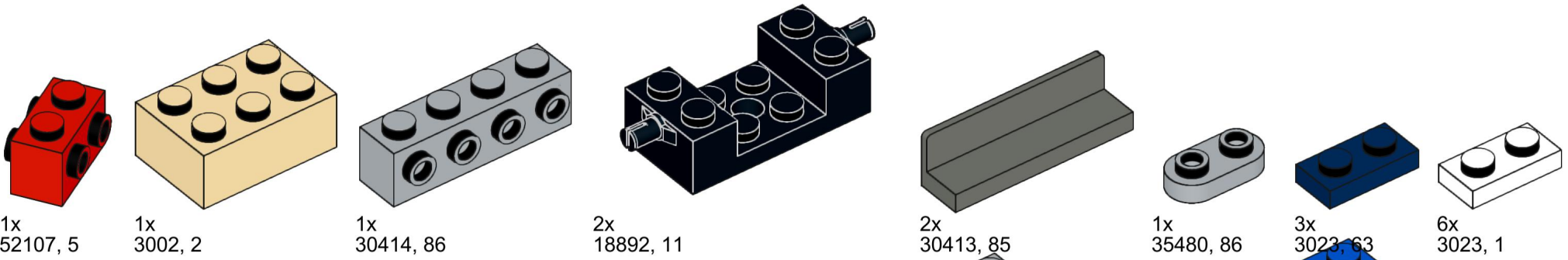

1x
52107, 5

1x
3002, 2

1x
30414, 86

2x
18892, 11

2x
30413, 85

1x
35480, 86

3x
3023, 63

6x
3023, 1

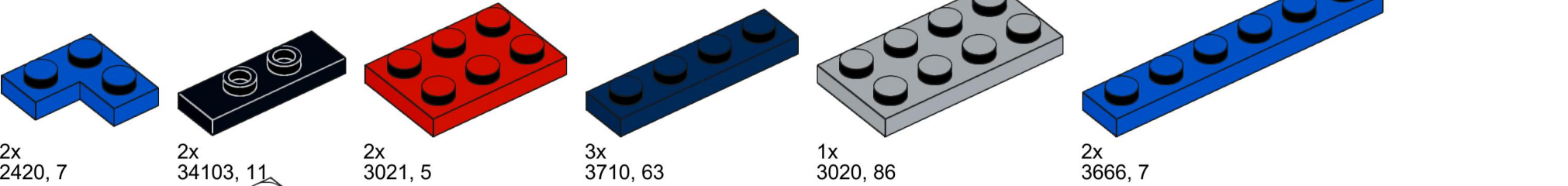

2x
2420, 7

2x
34103, 11

2x
3021, 5

3x
3710, 63

1x
3020, 86

2x
3666, 7

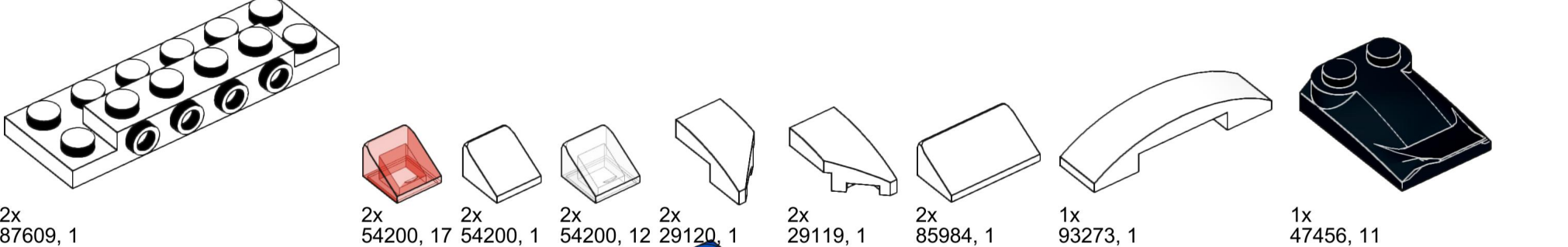

2x
87609, 1

2x
54200, 17

2x
54200, 1

2x
54200, 12

2x
29120, 1

2x
29119, 1

2x
85984, 1

1x
93273, 1

1x
47456, 11

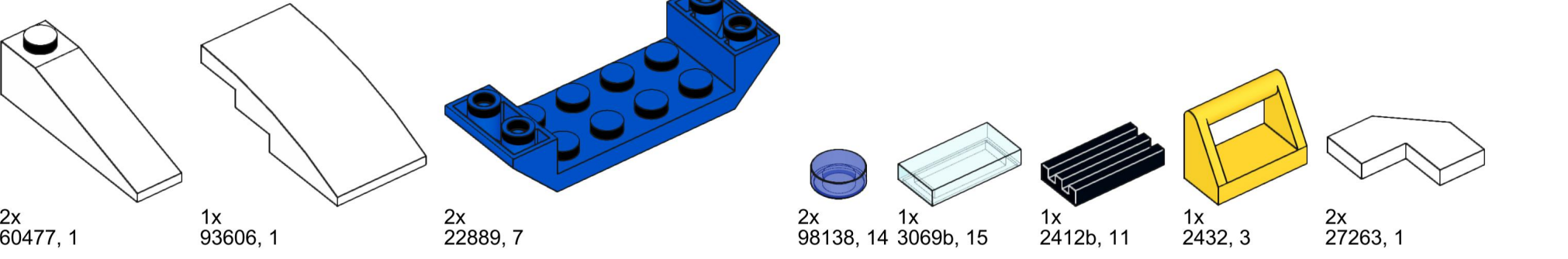

2x
60477, 1

1x
93606, 1

2x
22889, 7

2x
98138, 14

1x
3069b, 15

1x
2412b, 11

1x
2432, 3

2x
27263, 1

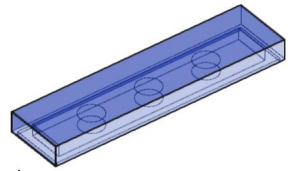

1x
2431, 14

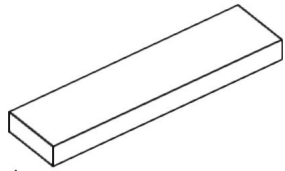

1x
2431, 1

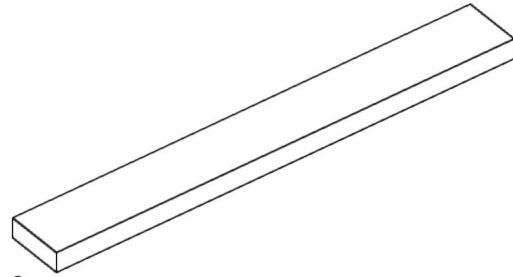

2x
4162, 1



4x
11209, 11

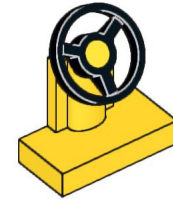

1x
3829c01, 3

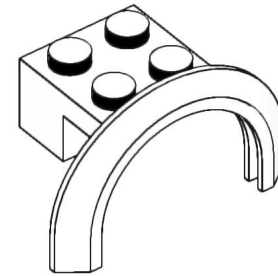

4x
50745, 1

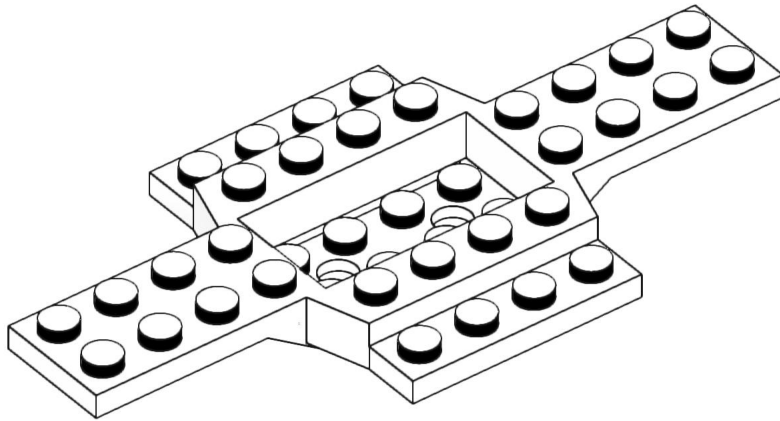

1x
28324, 1

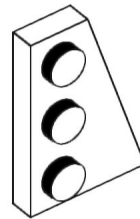

1x
43722, 1

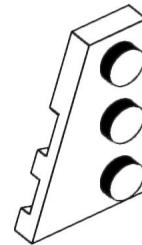

1x
43723, 1



1x
98281, 1

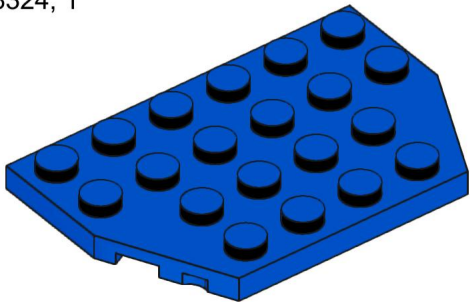

1x
32059, 7

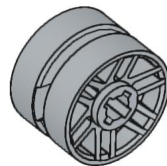

4x
11208, 86

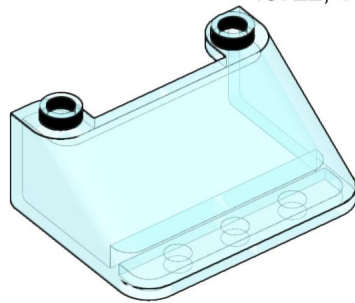

1x
57783, 15



1x

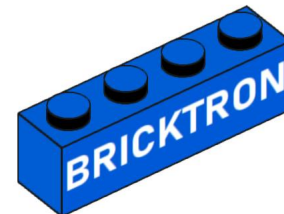

2x