

2x

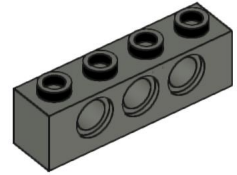

2x



2x

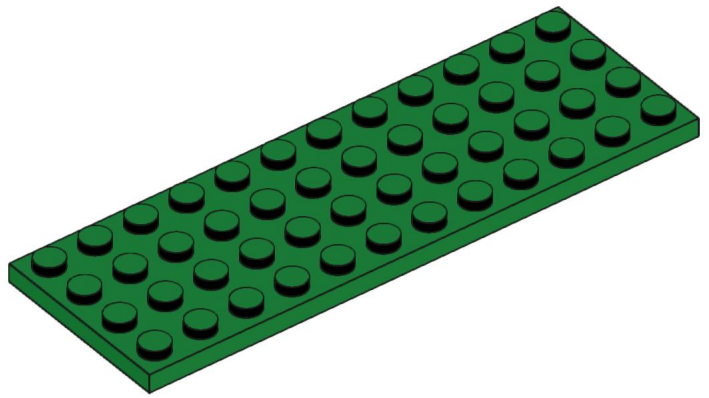

1x

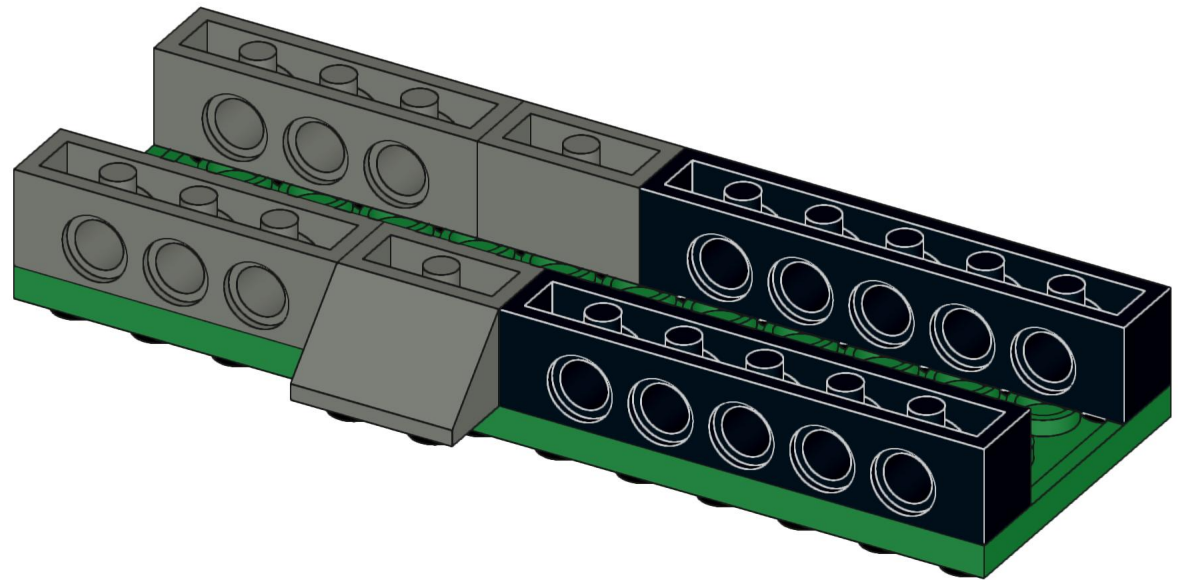

2

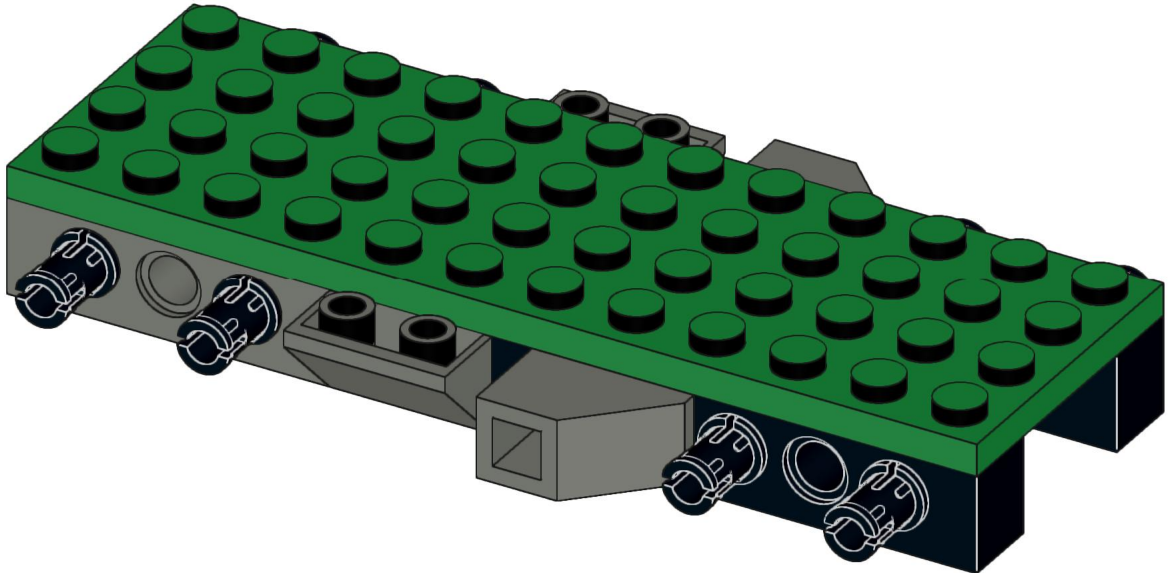
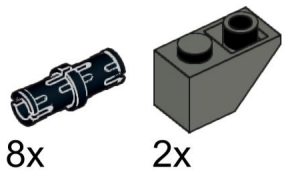

3

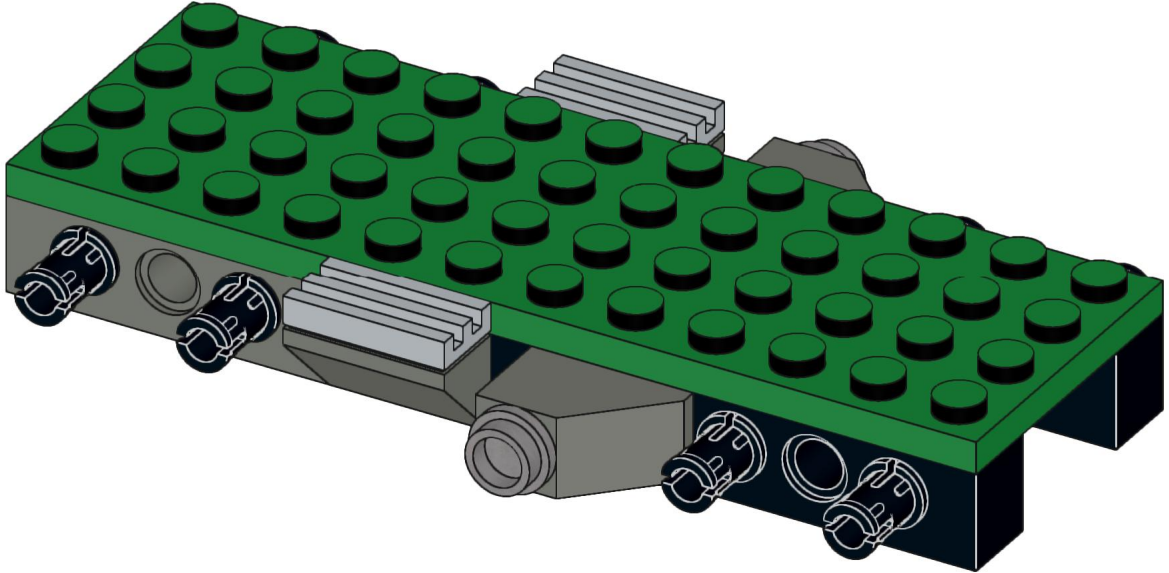
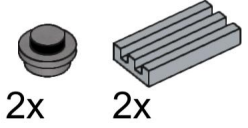

4

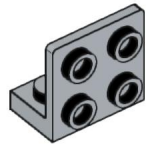

1x

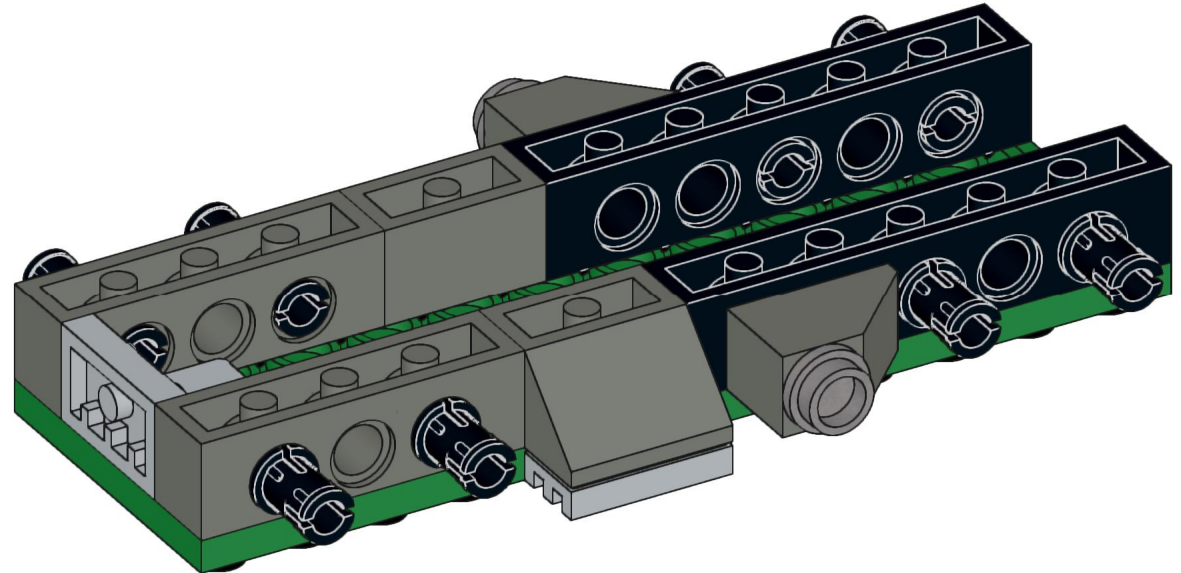

5



4x



4x

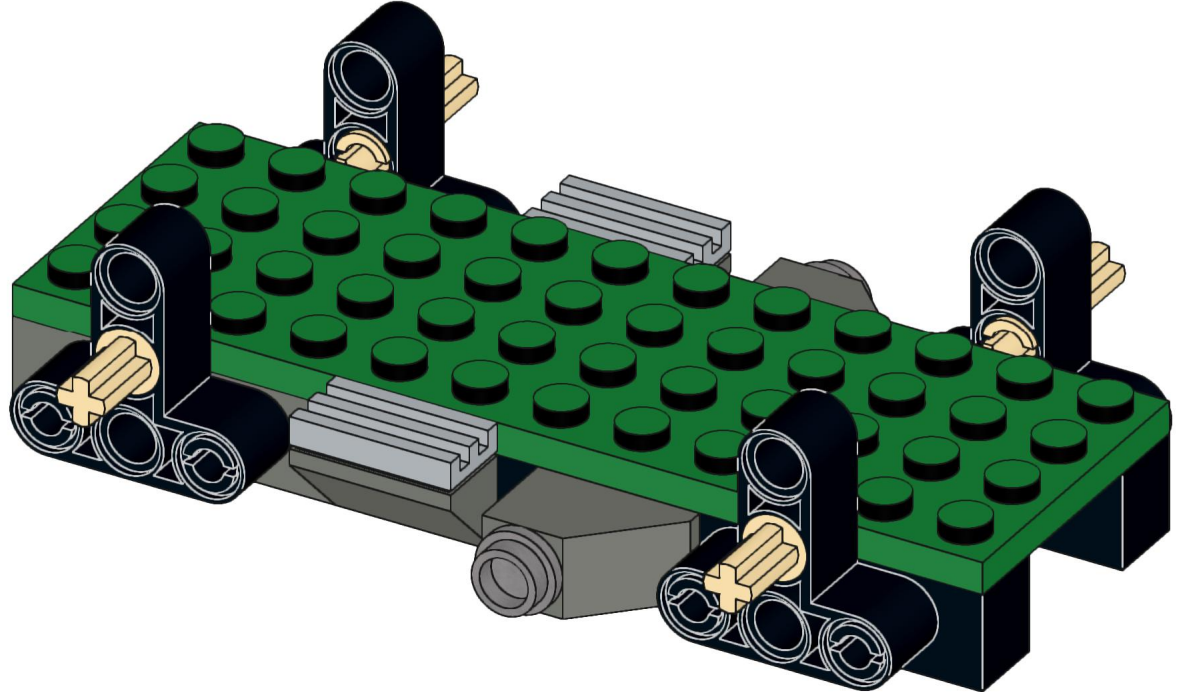

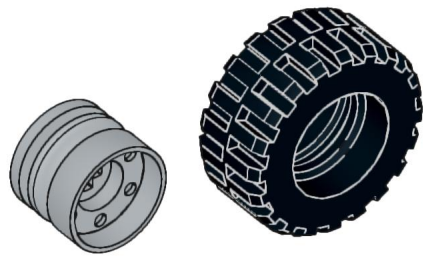

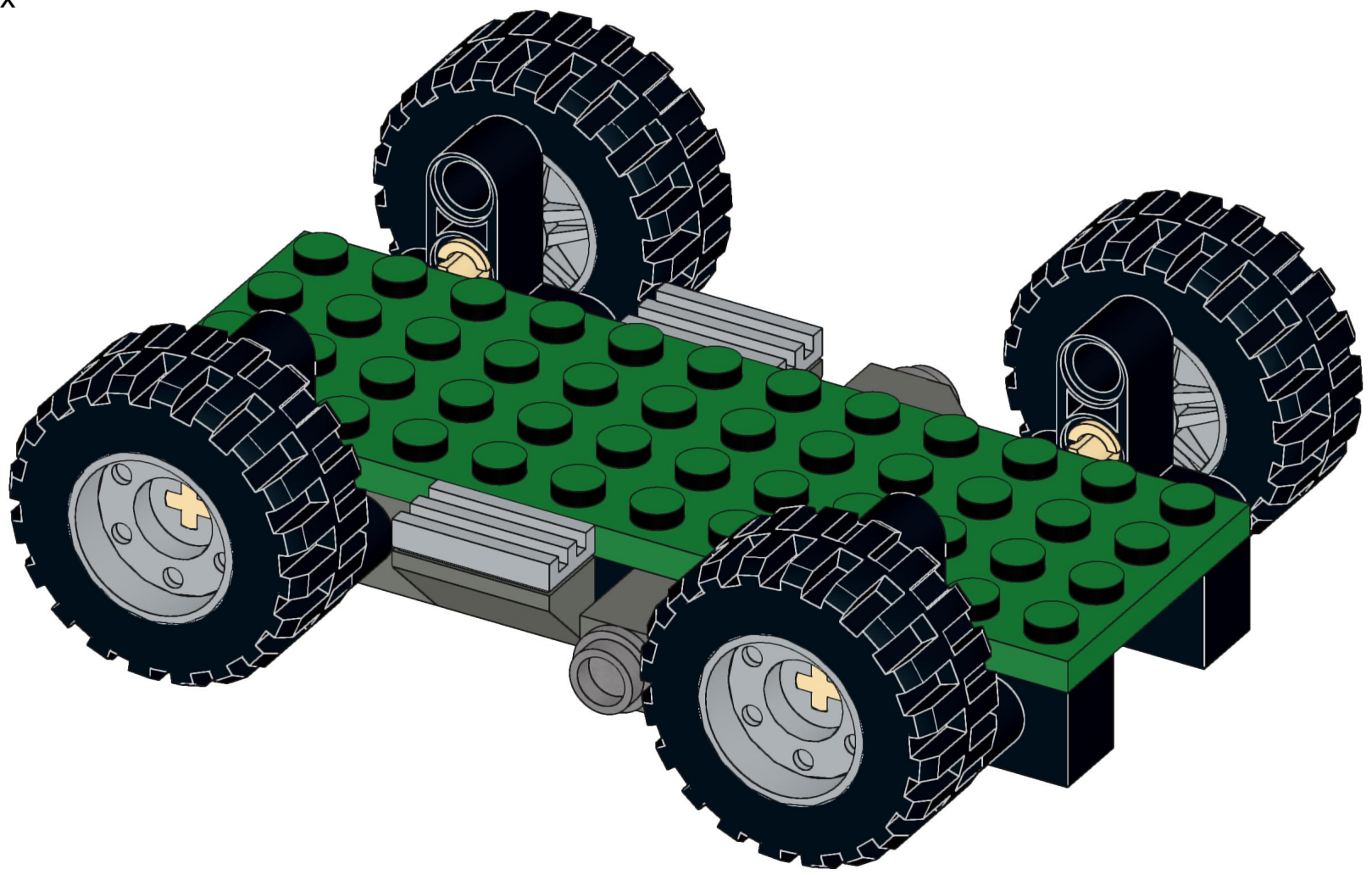

4x

4x

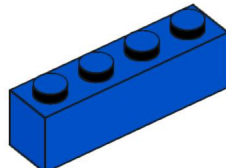
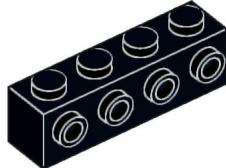

- 2x 
- 1x 
- 1x 
- 1x 

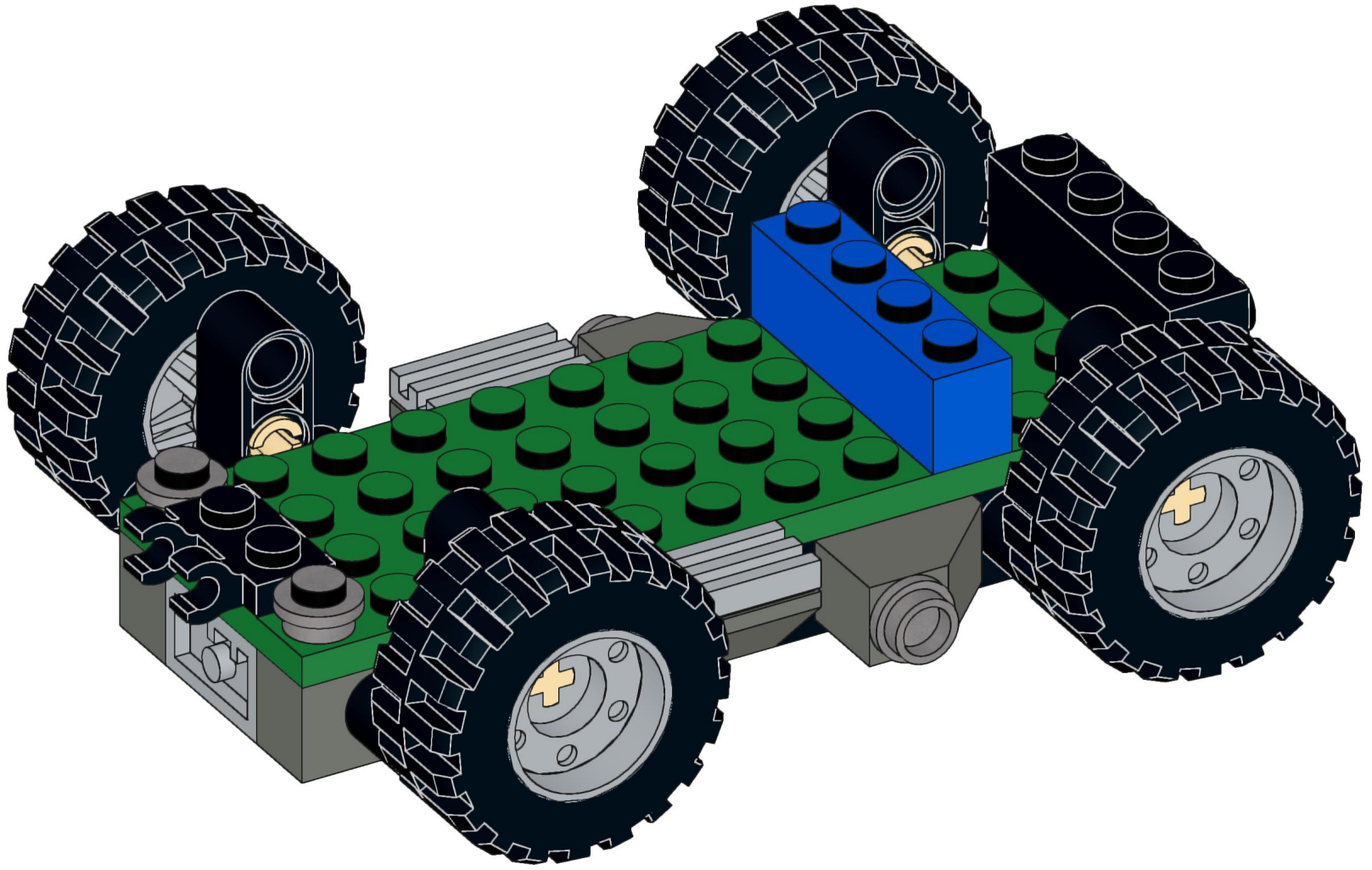

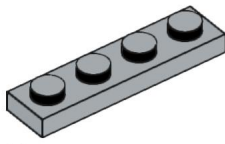

2x

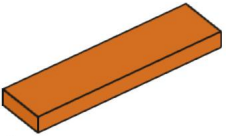

1x

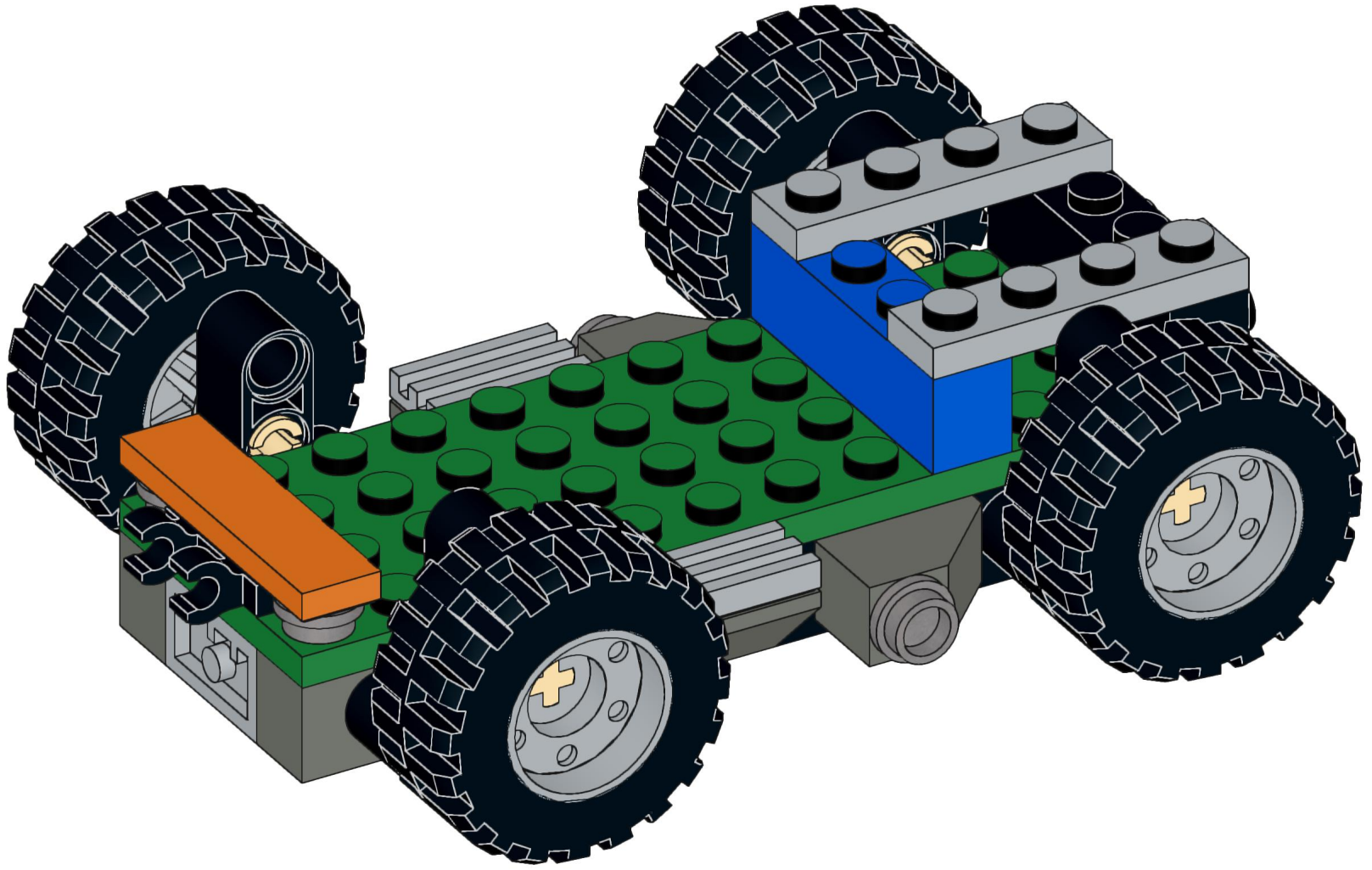

9

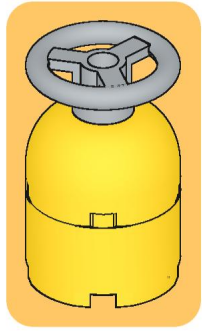
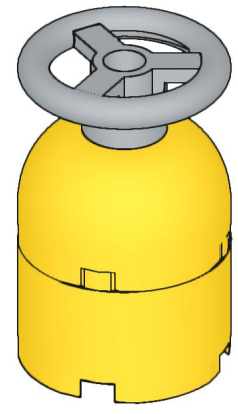
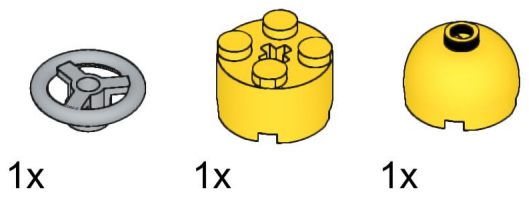

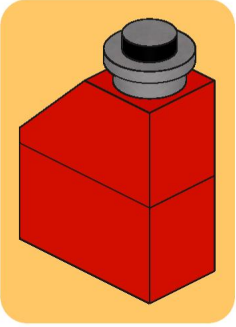
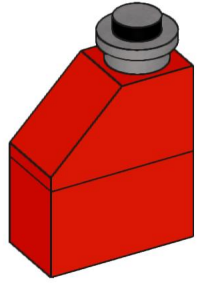
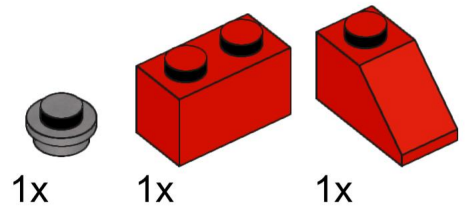

10

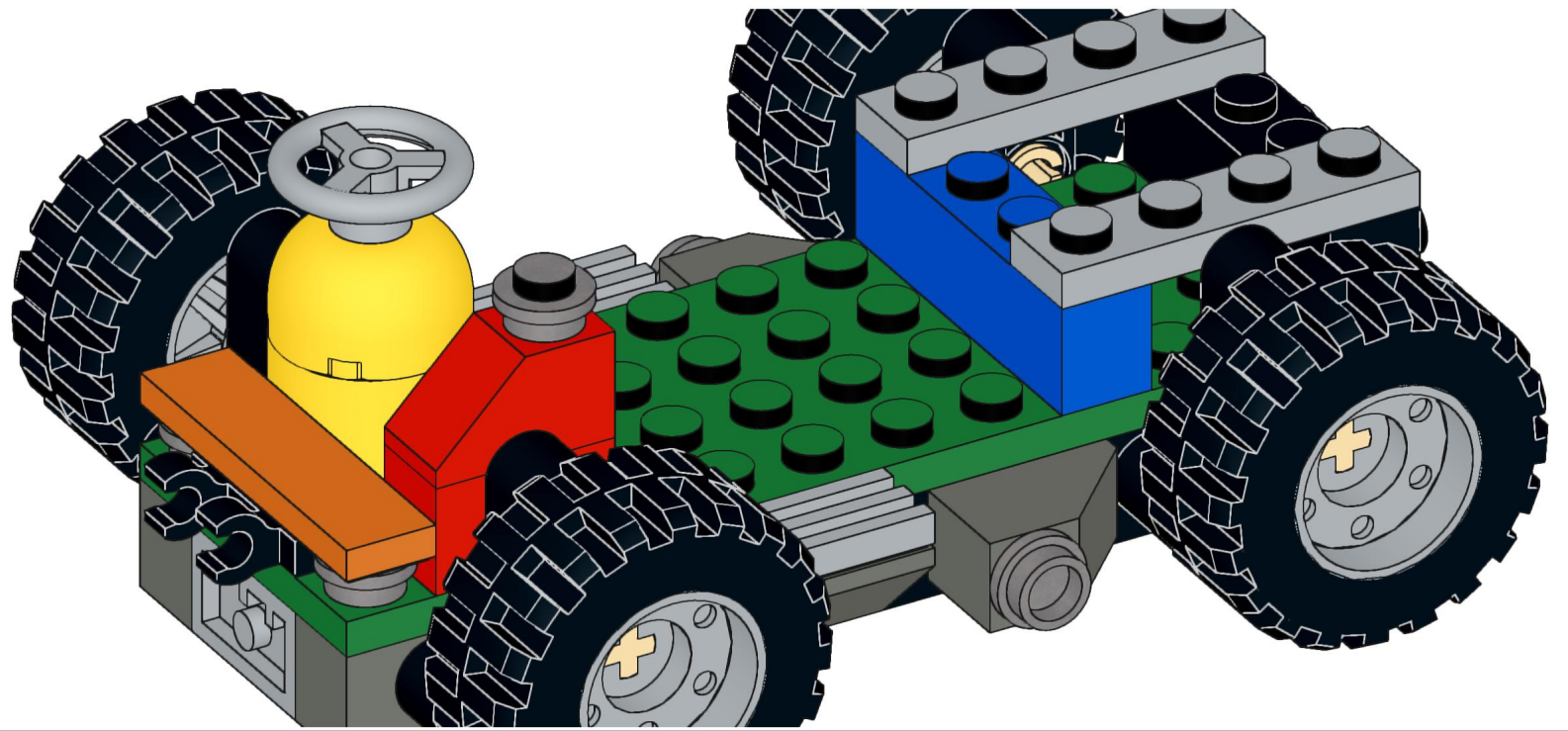

11

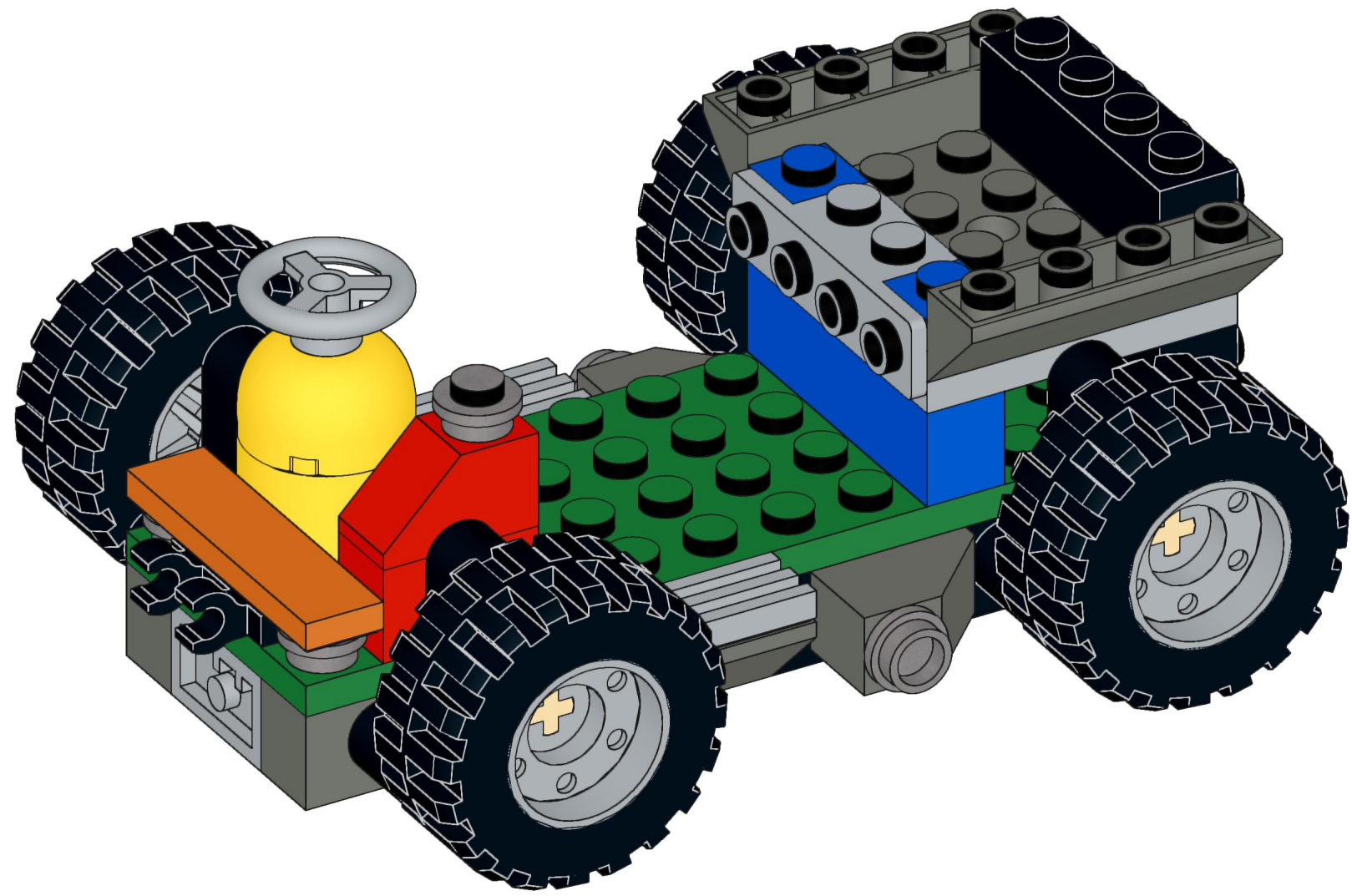
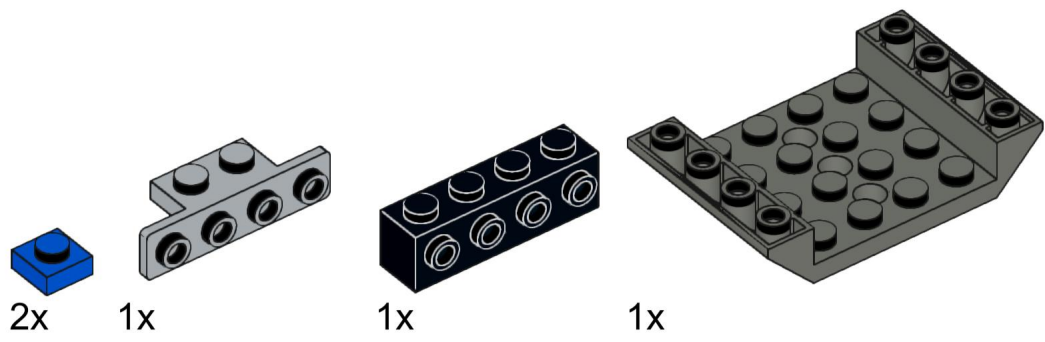

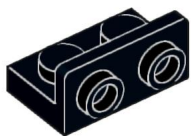
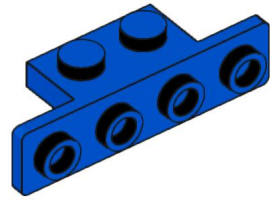

- 2x 
- 2x 
- 2x 
- 2x 

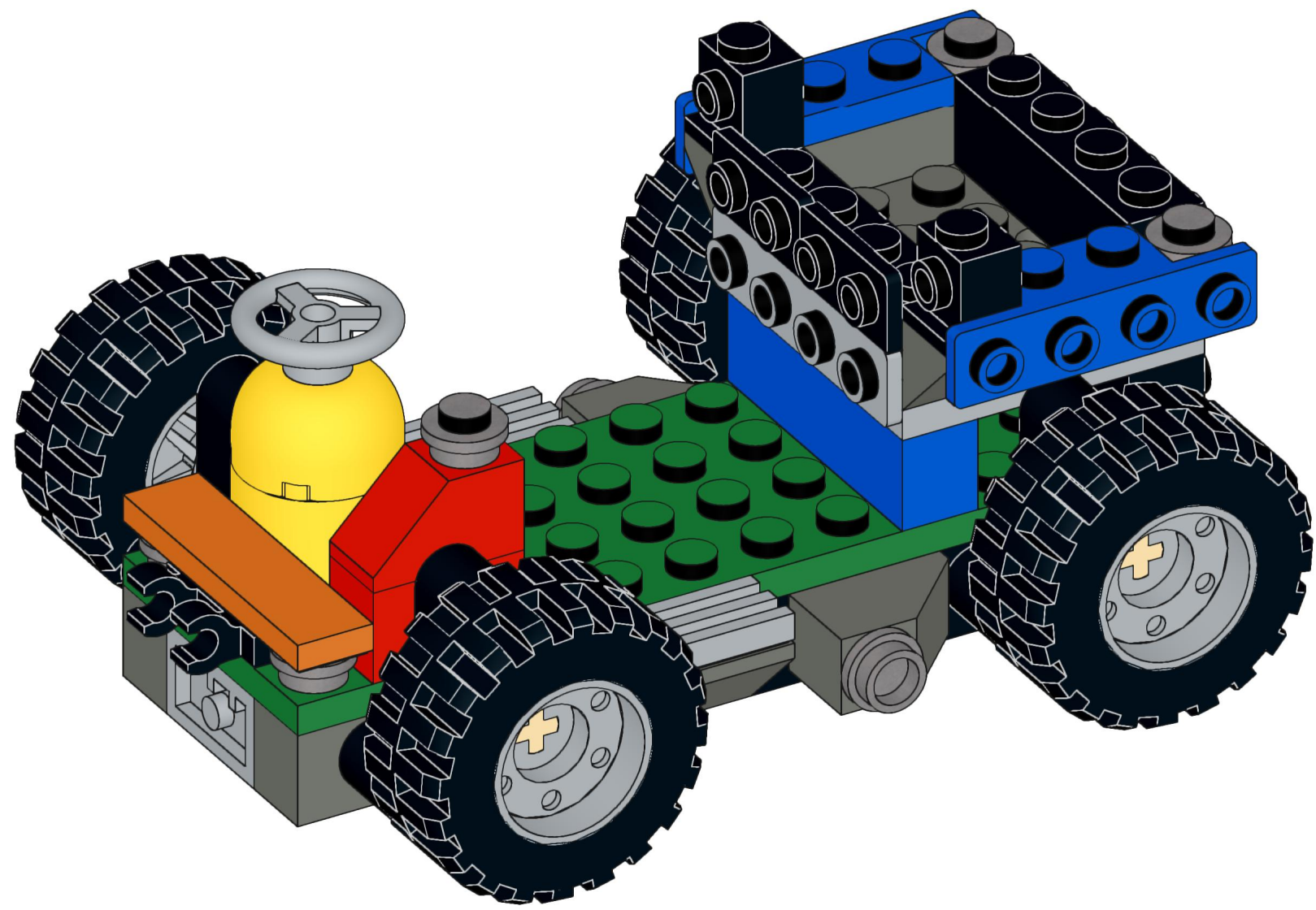

14

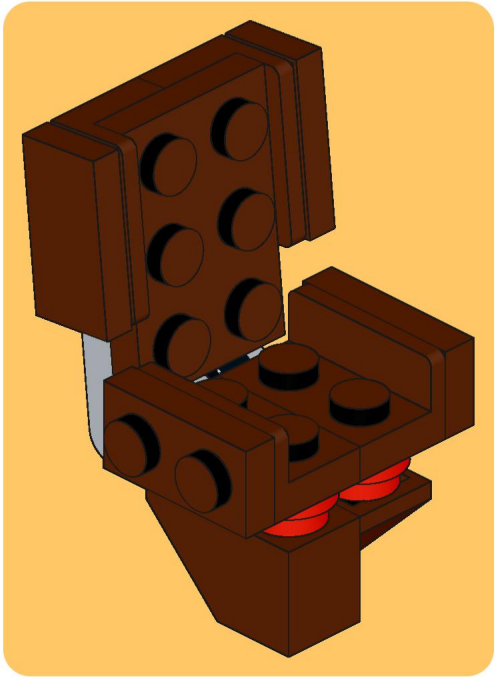
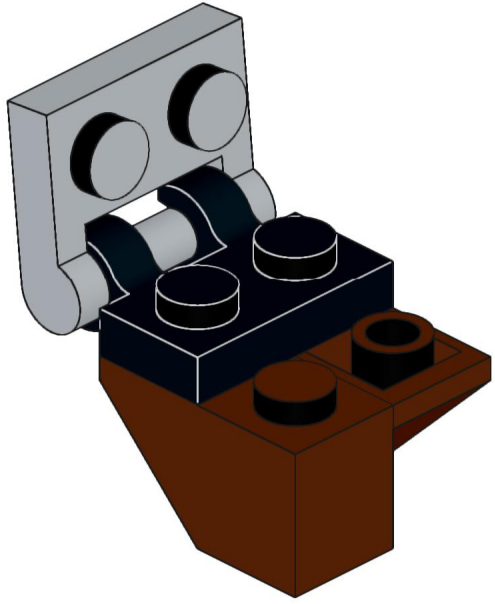
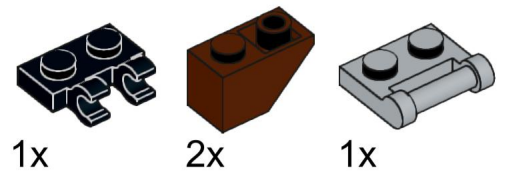

15

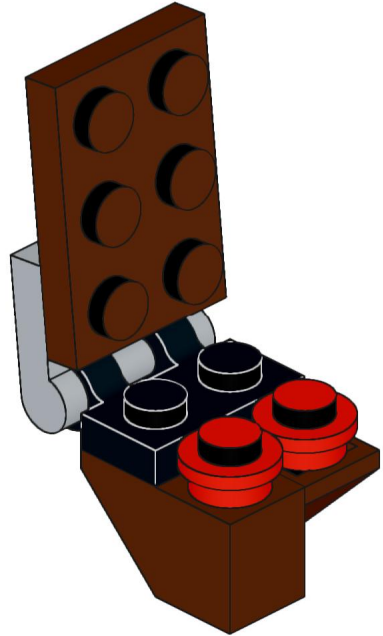
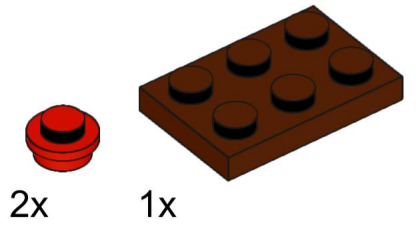

16

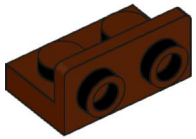

4x

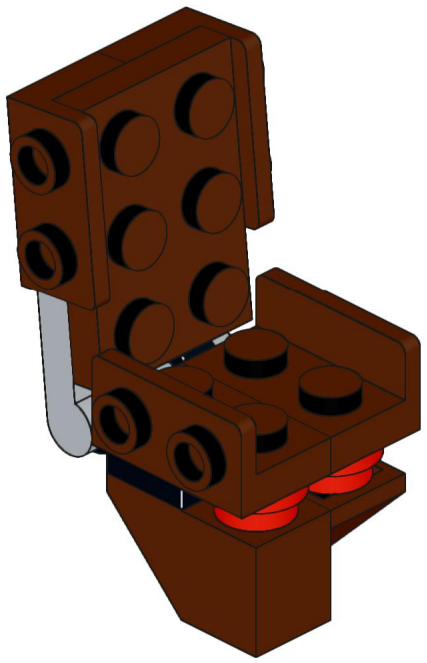

17

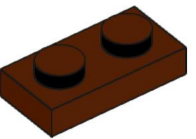

2x

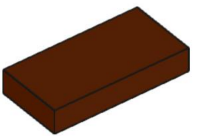

2x

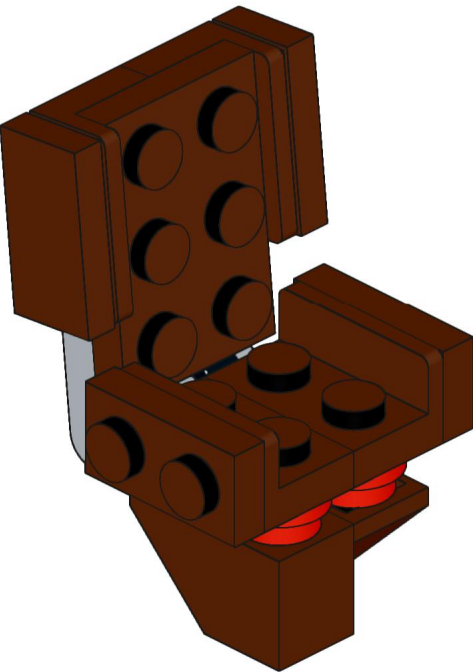

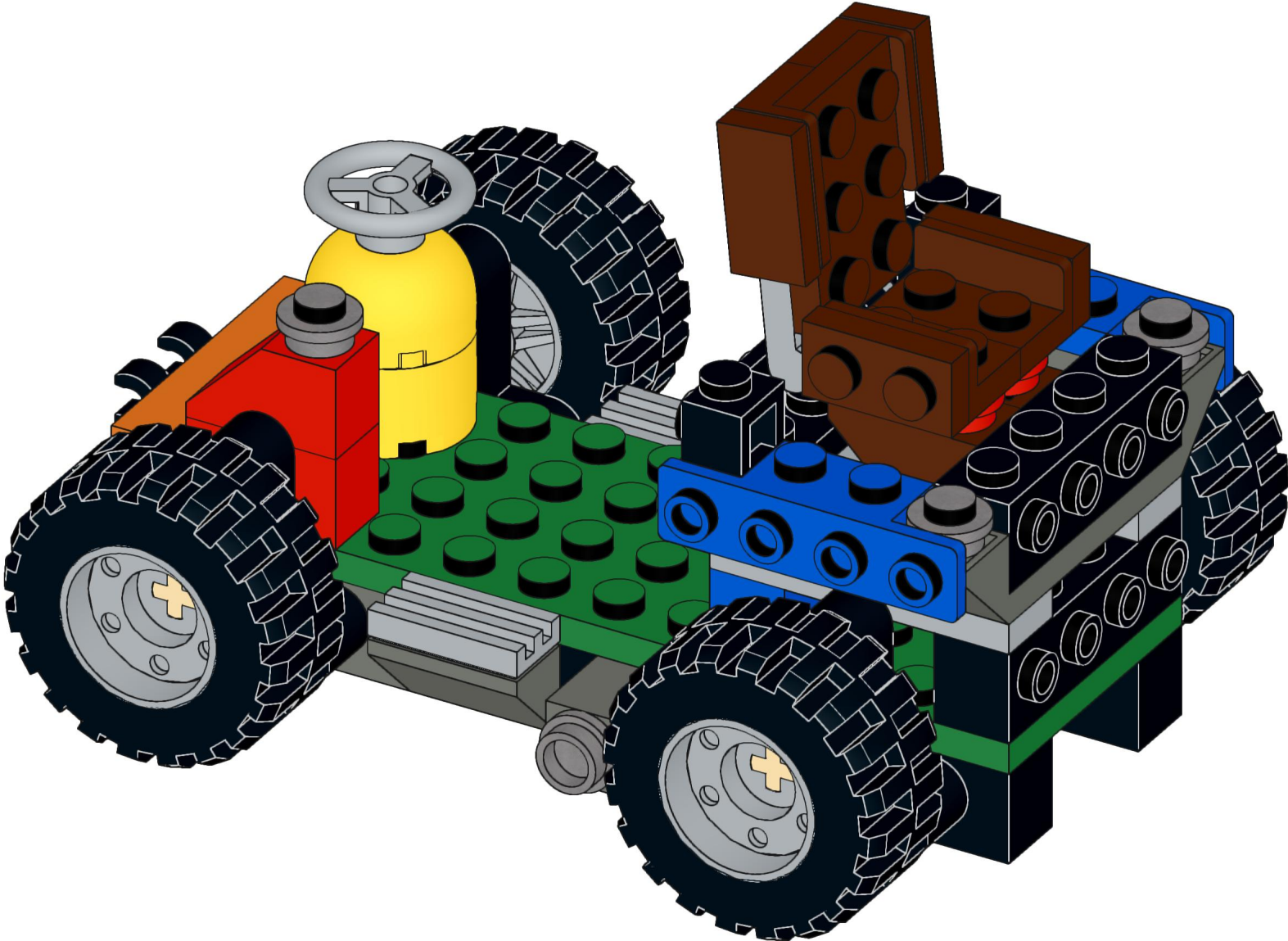

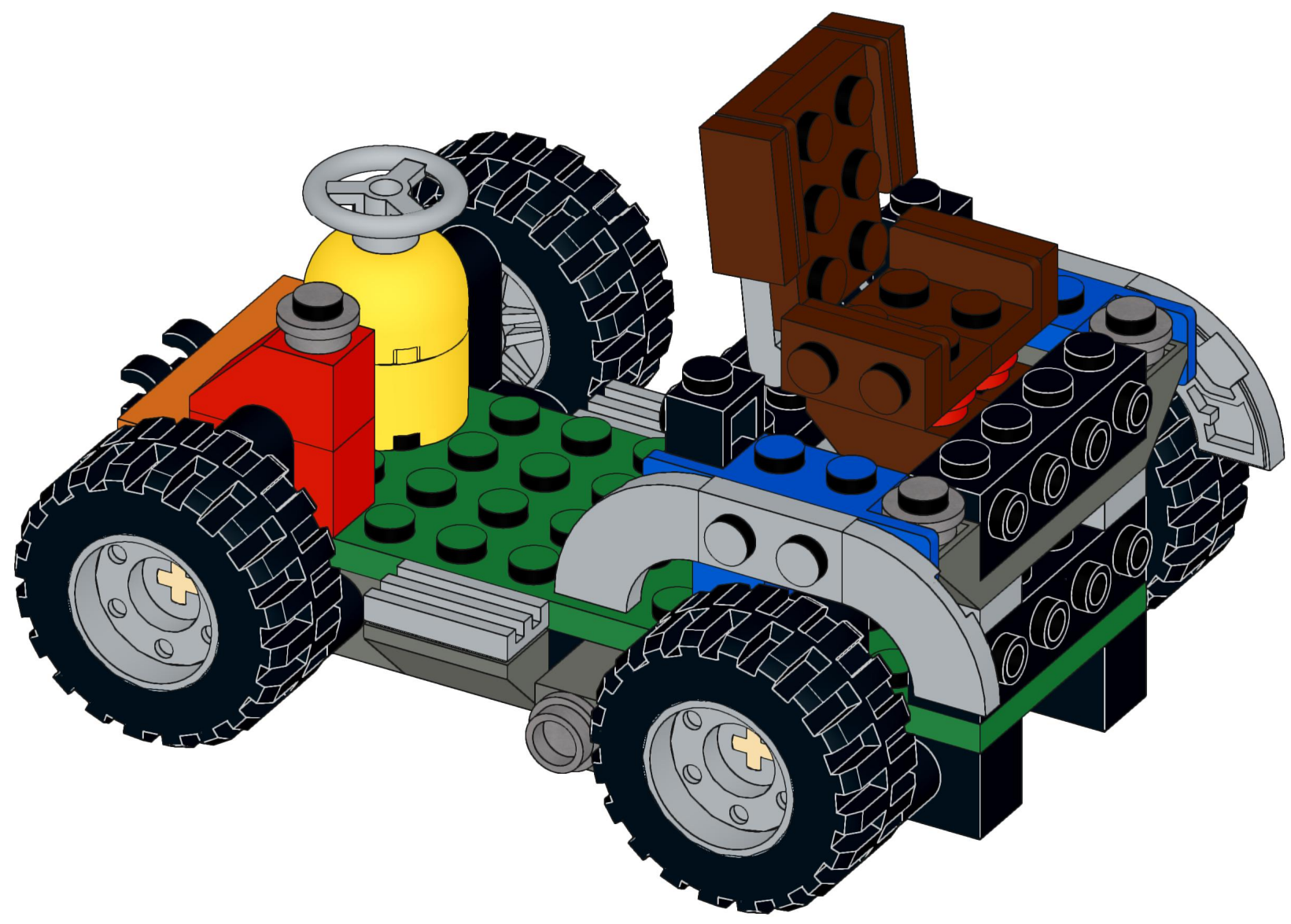
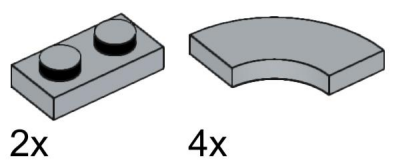

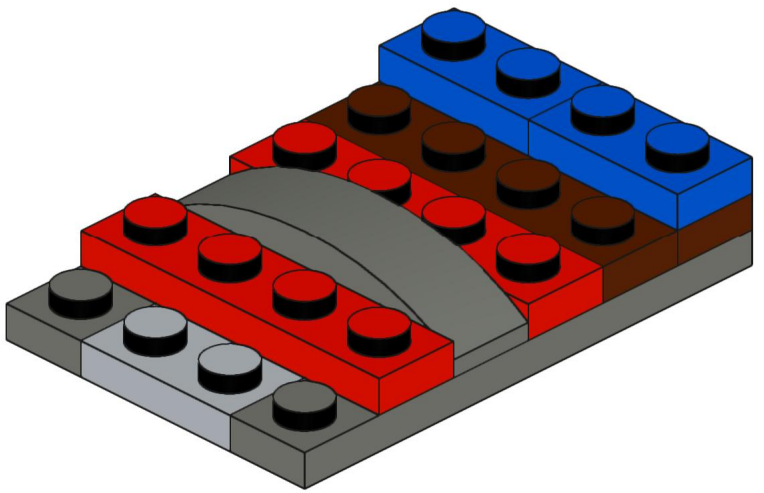
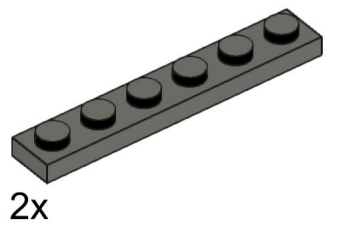
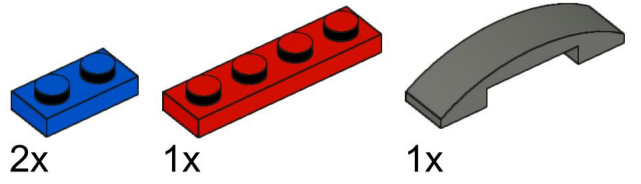
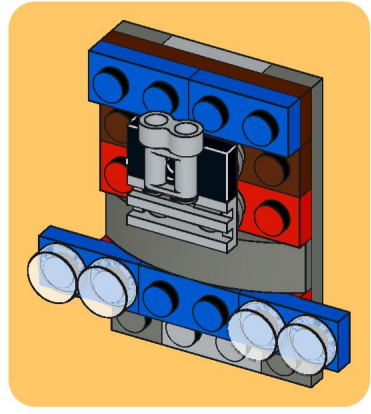
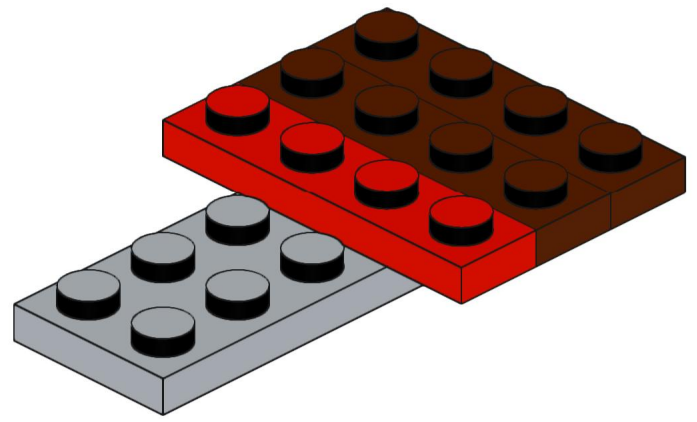
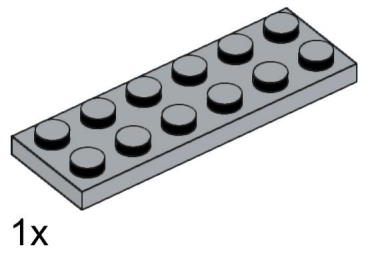
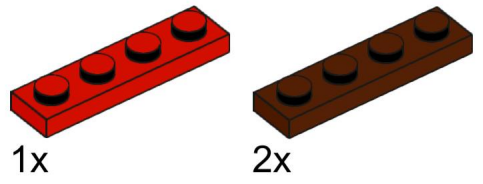

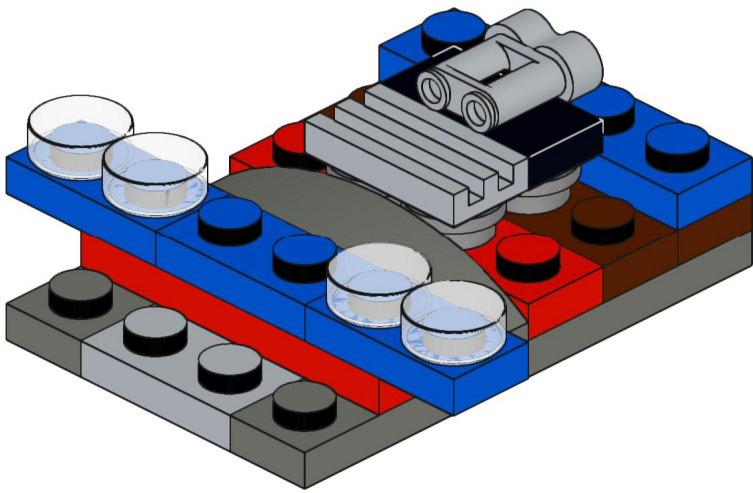
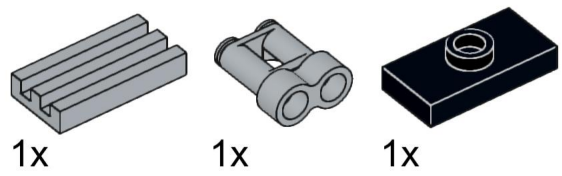
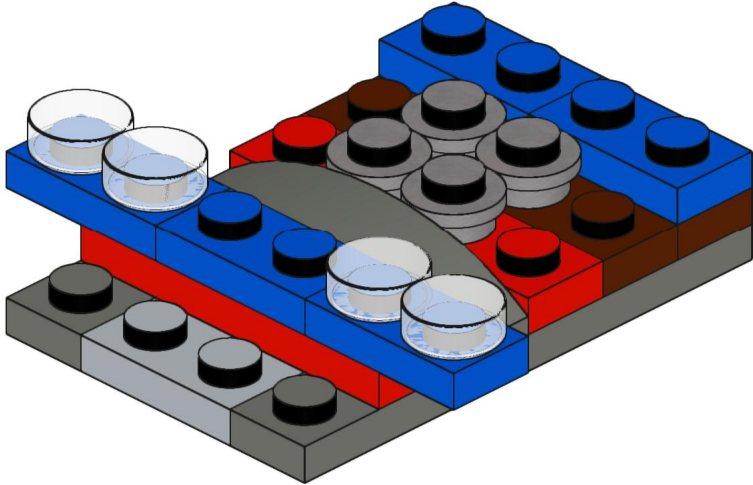
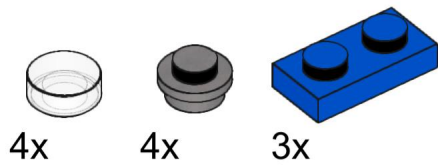

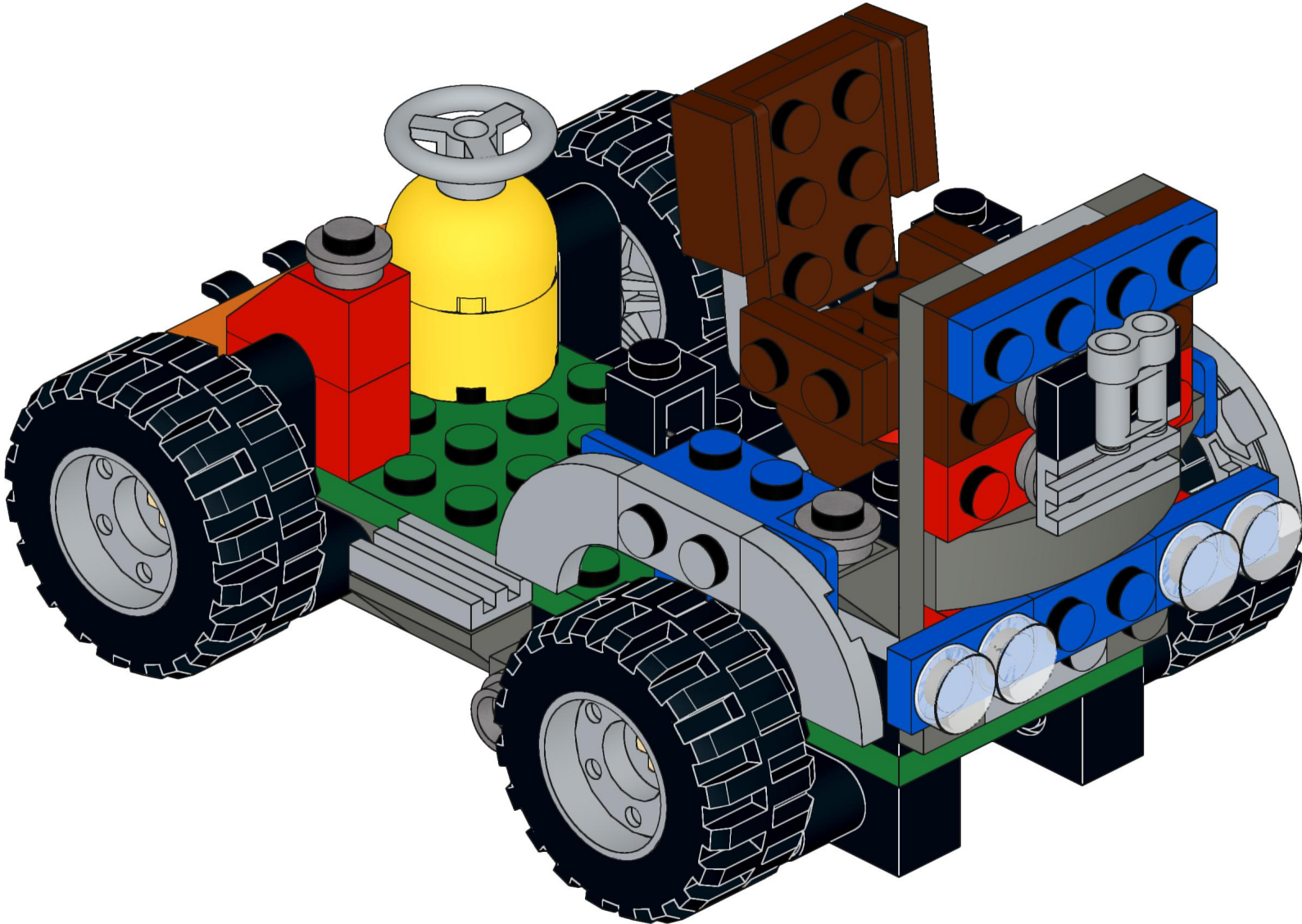

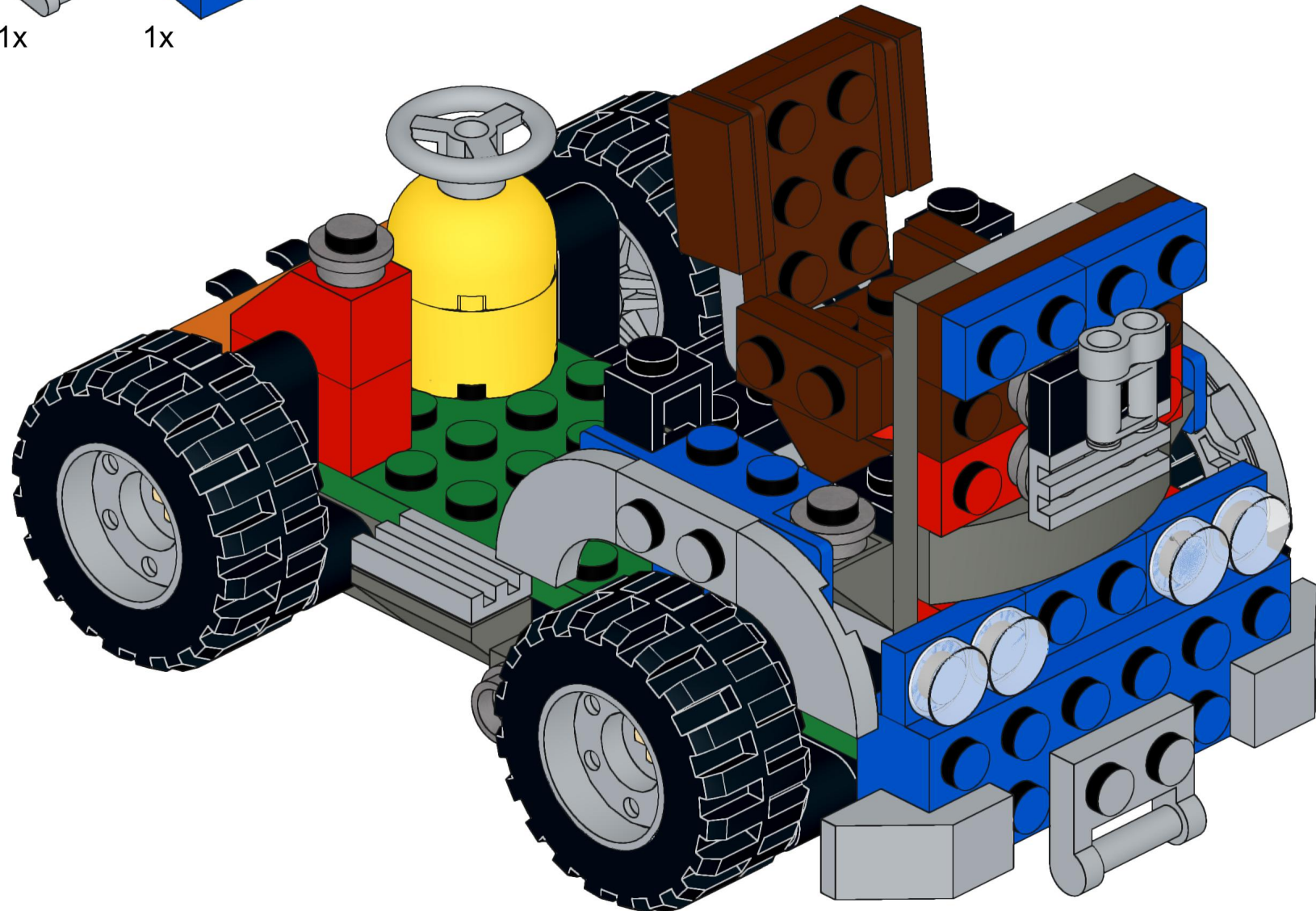
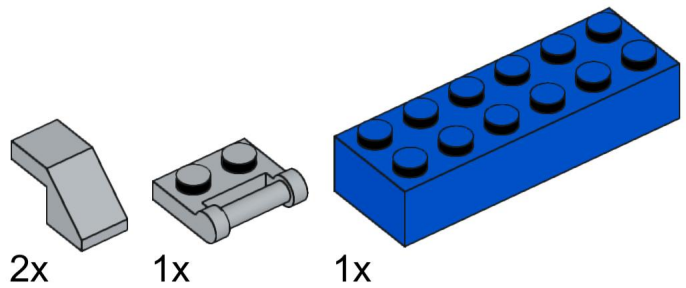



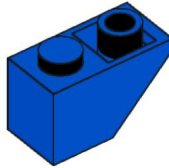
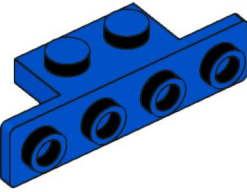

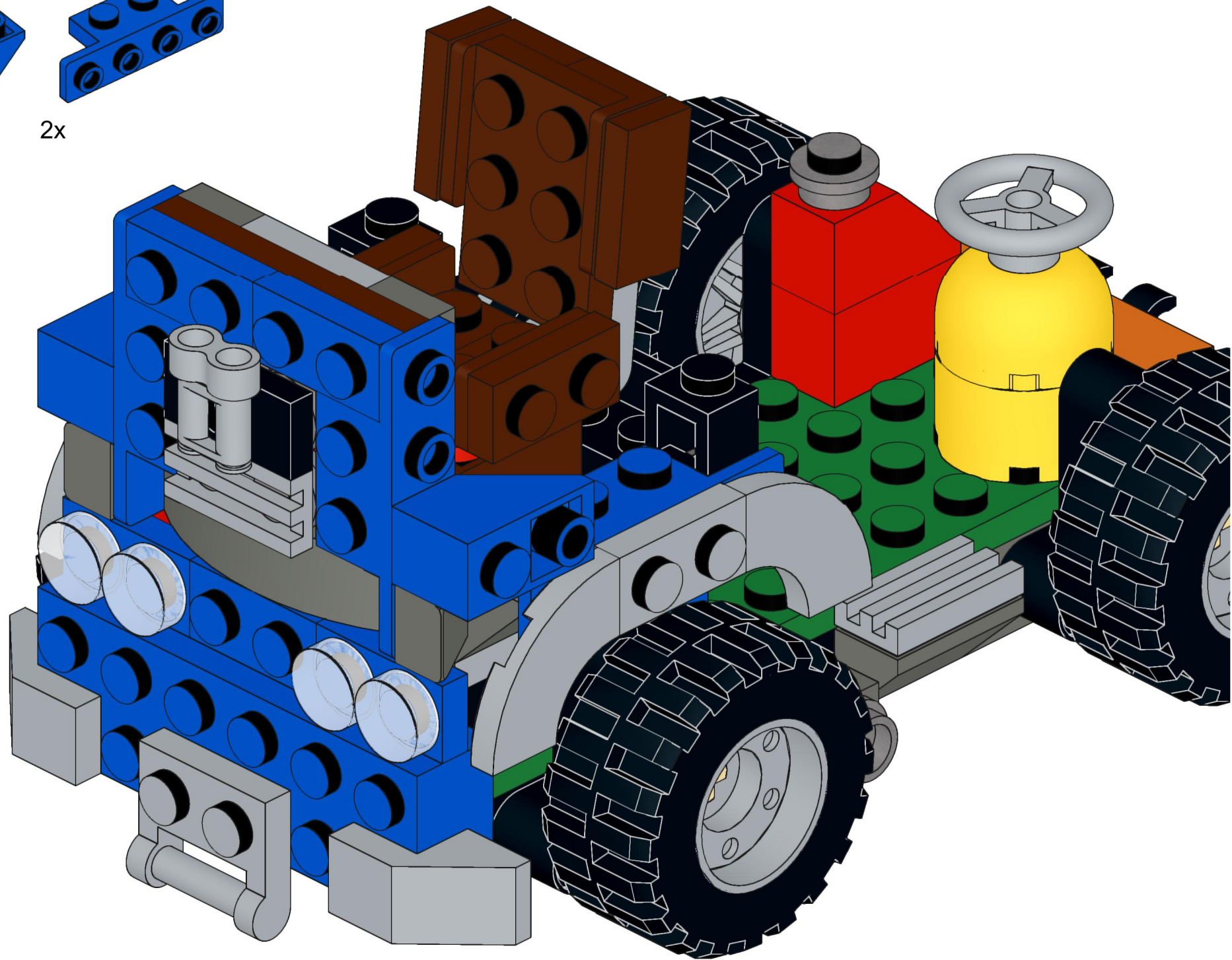
- 2x 
- 2x 
- 2x 

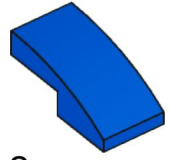
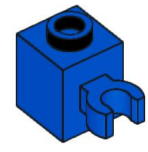

-  2x
-  2x
-  2x

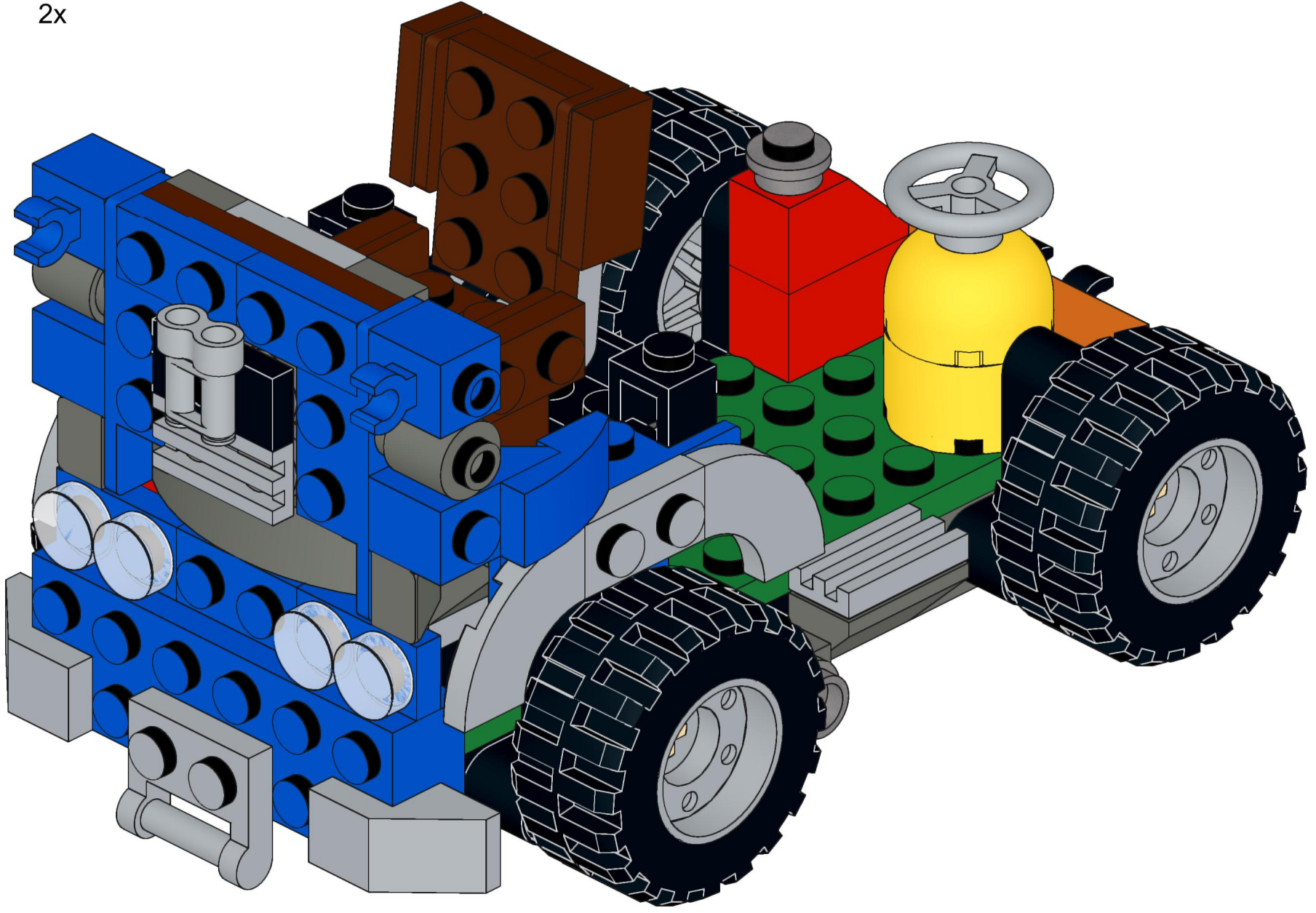

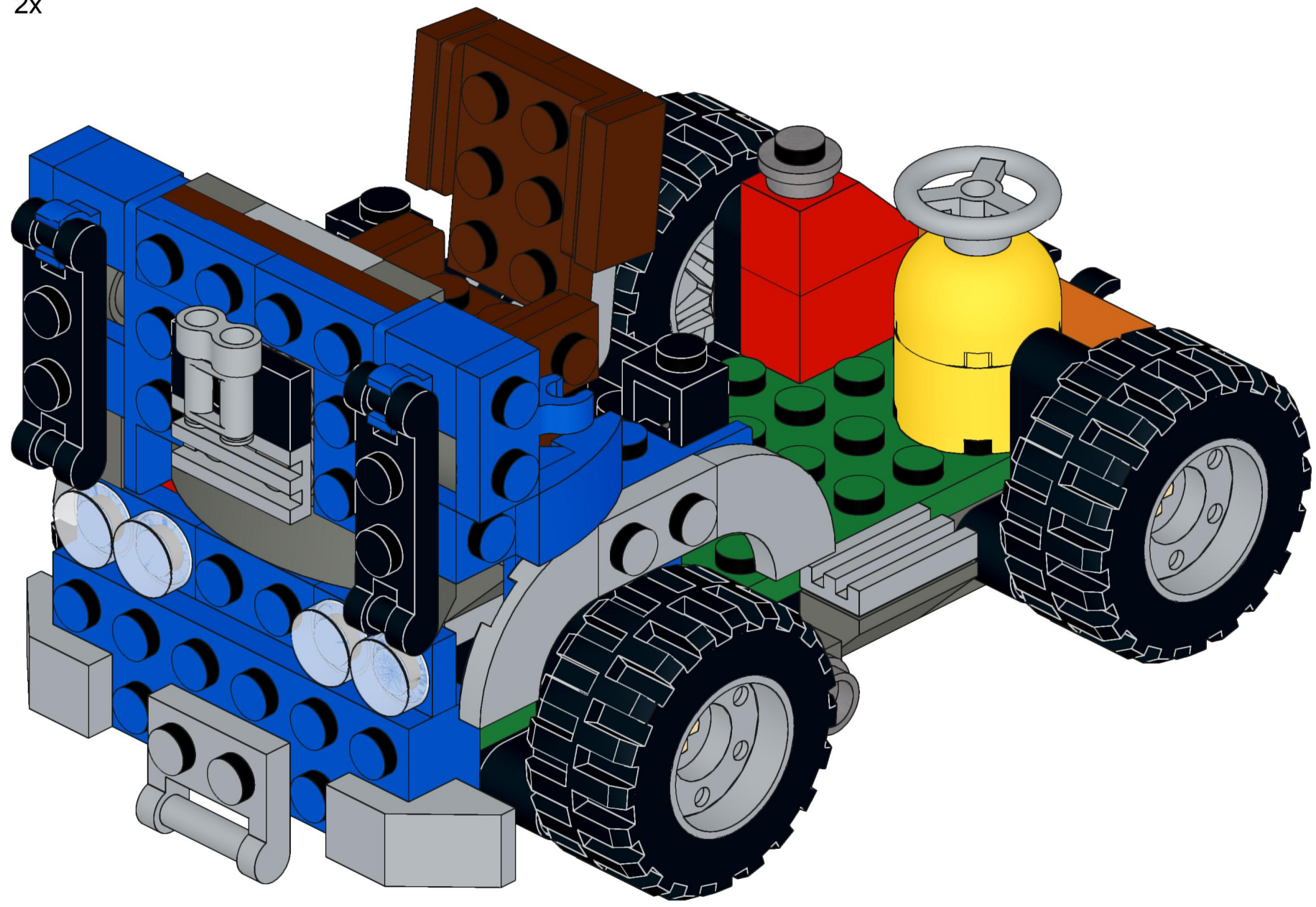
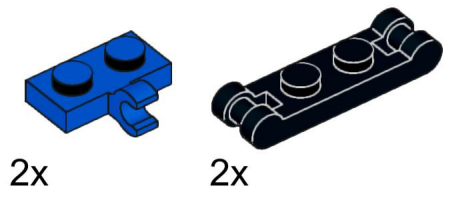

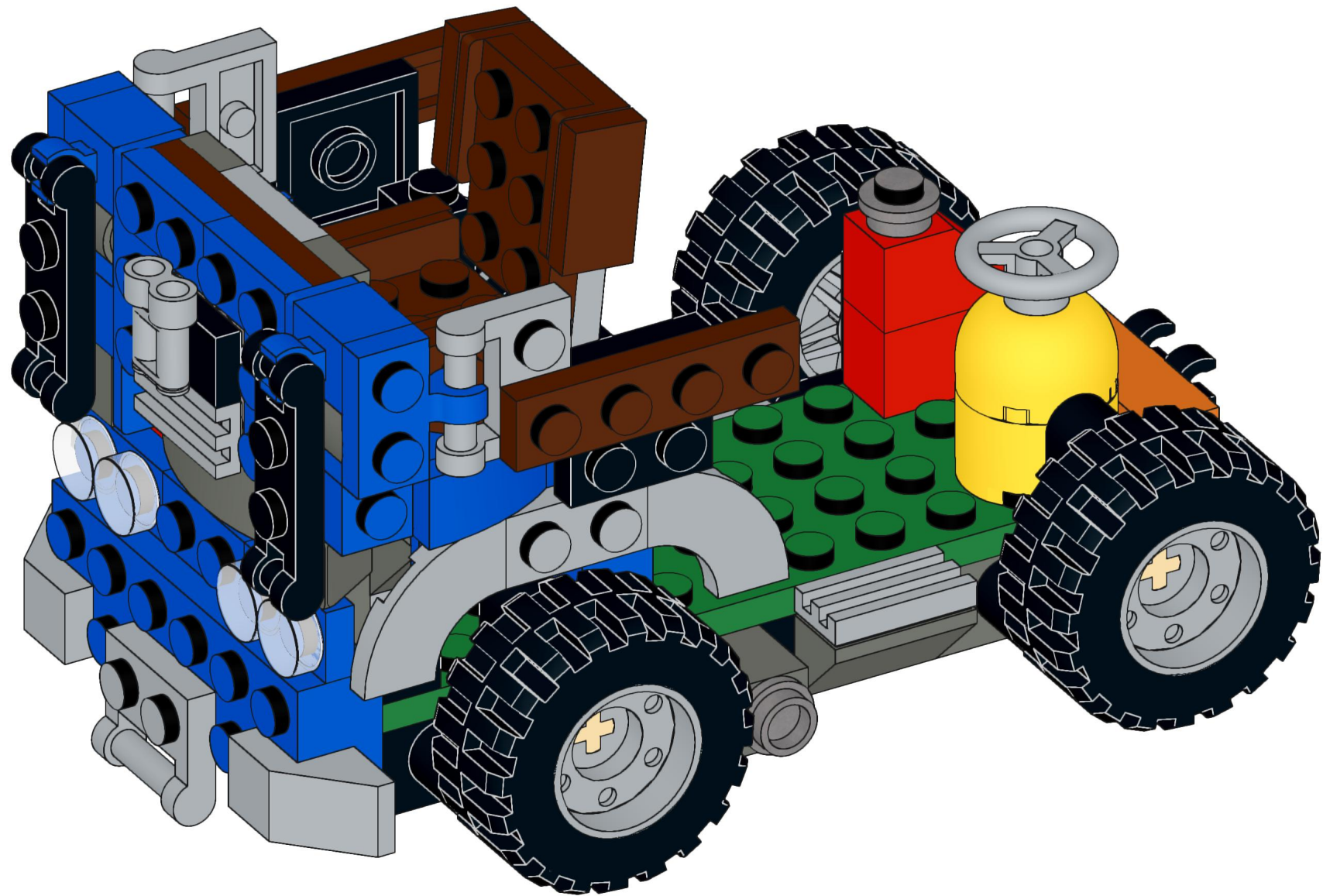
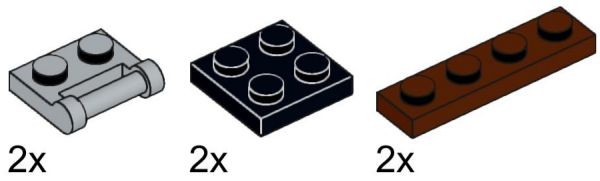

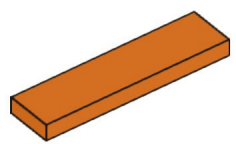

2x

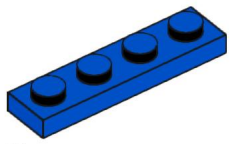

2x

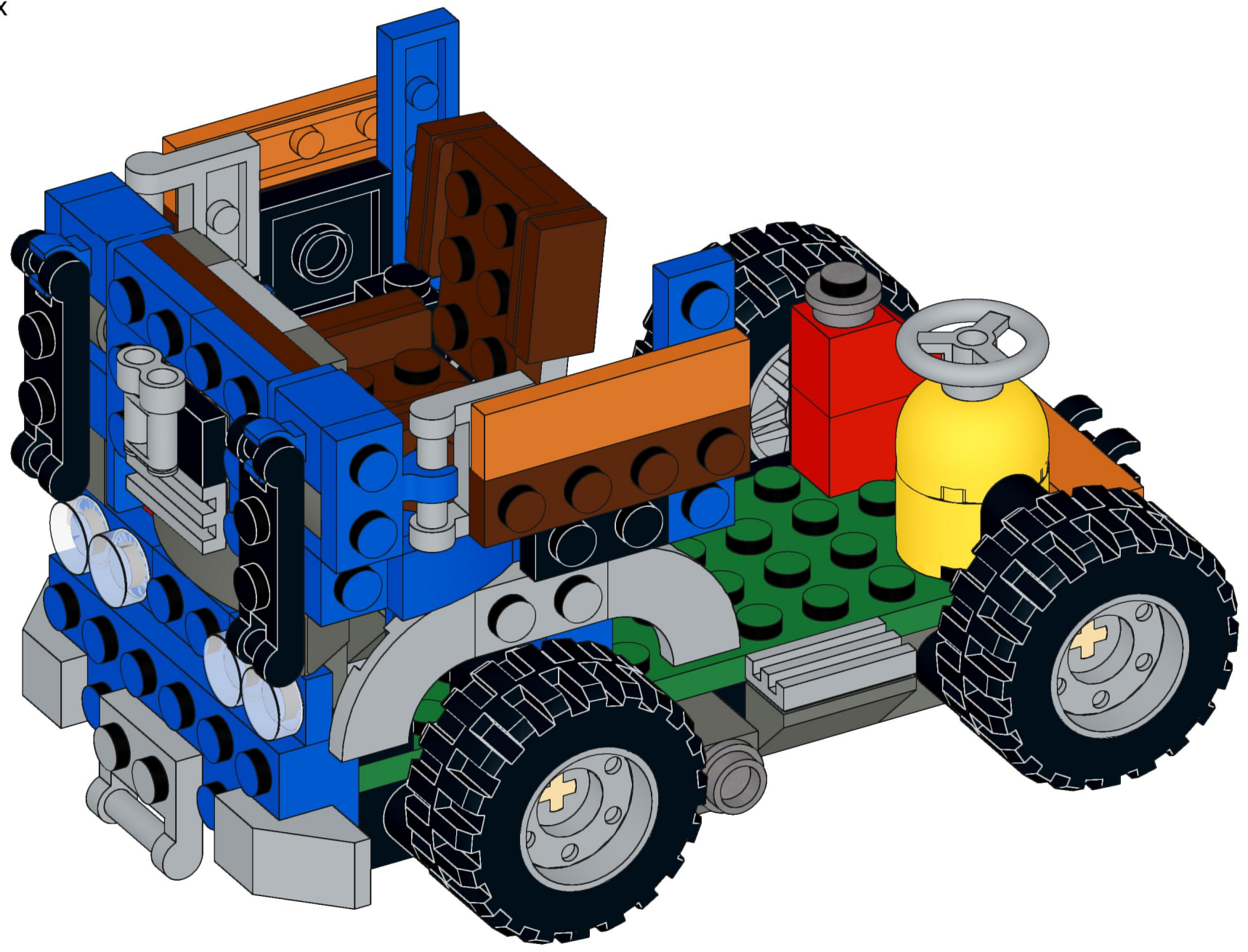

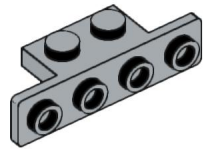

1x

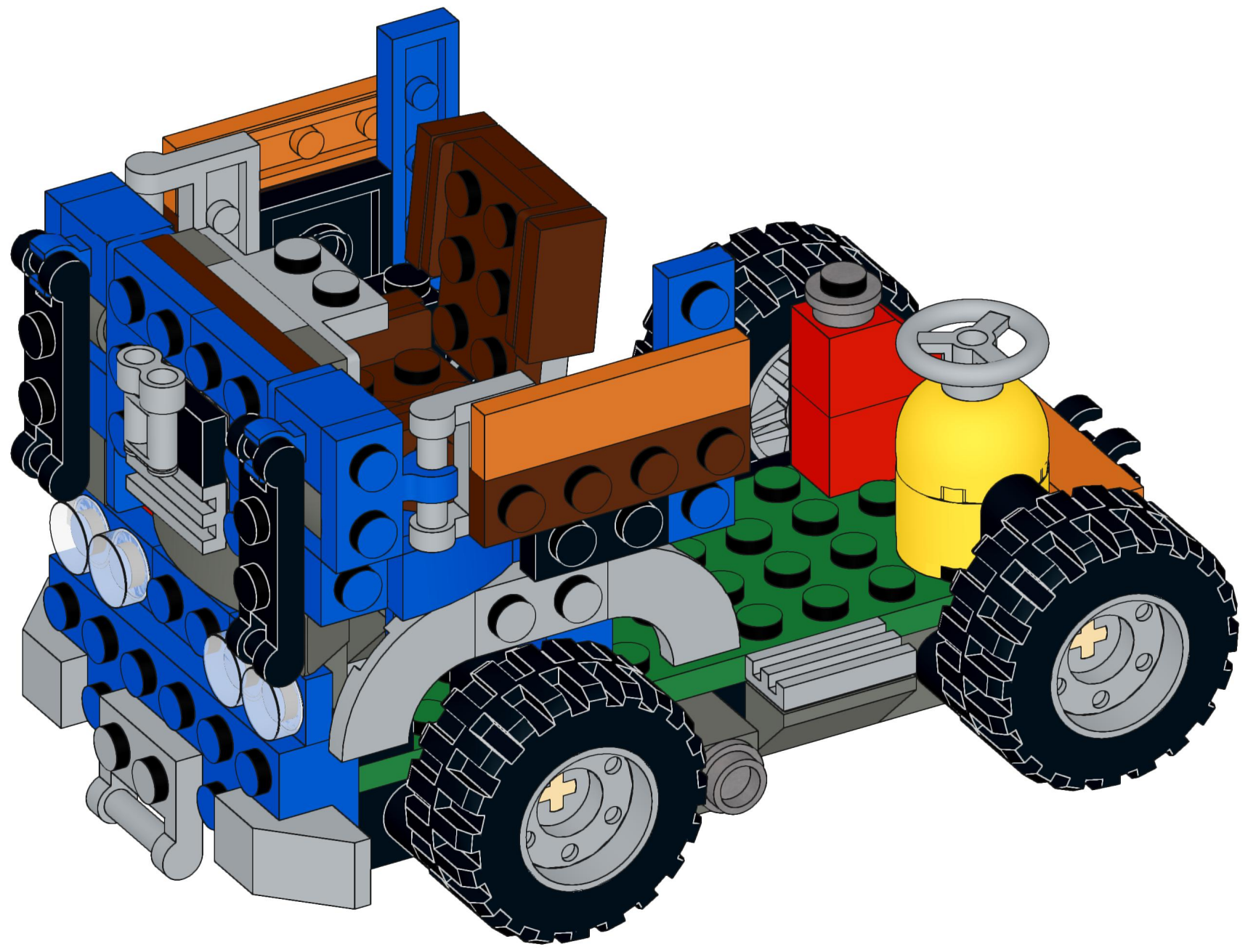

32

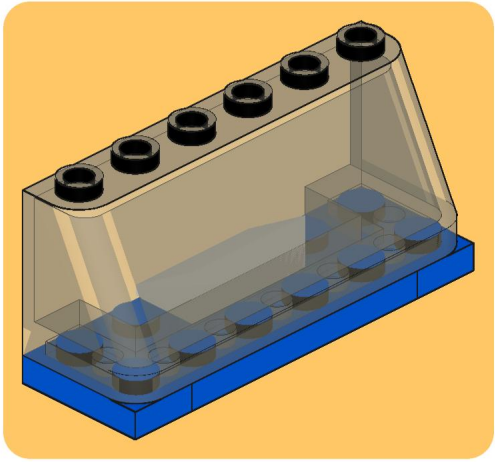
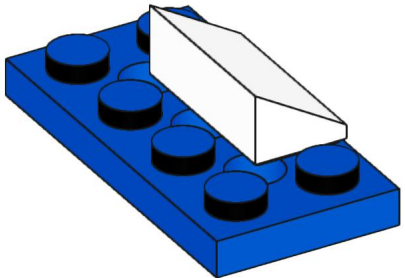
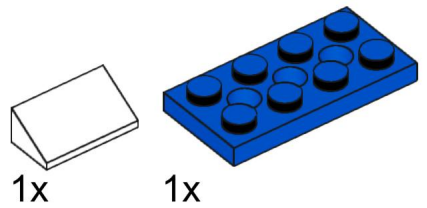

33

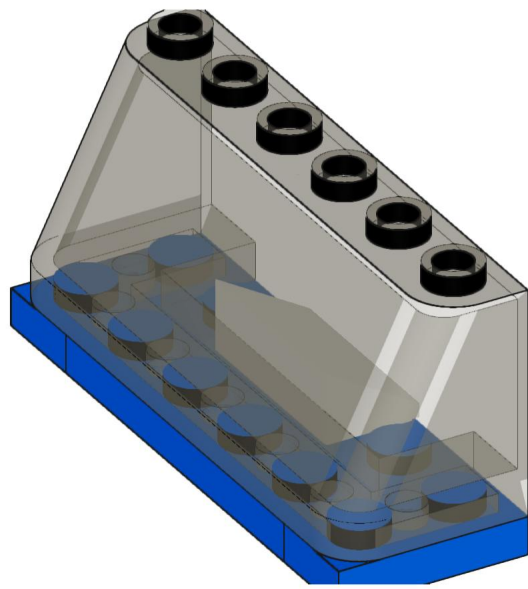
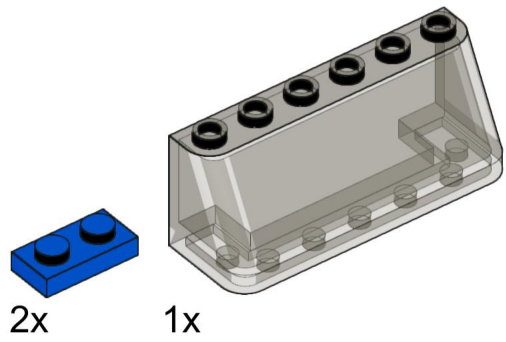

34

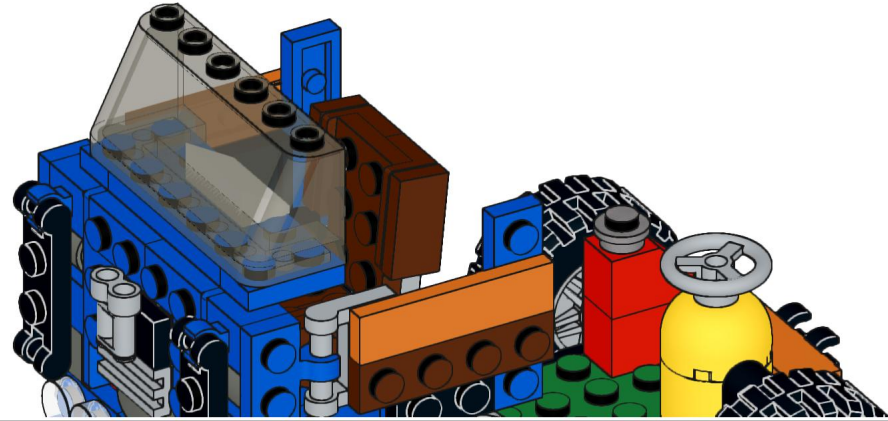

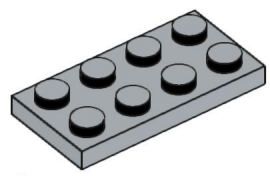

1x

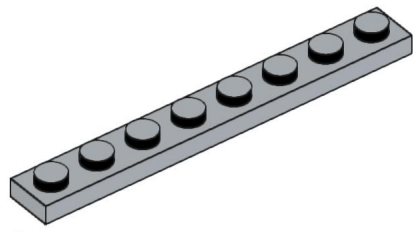

2x

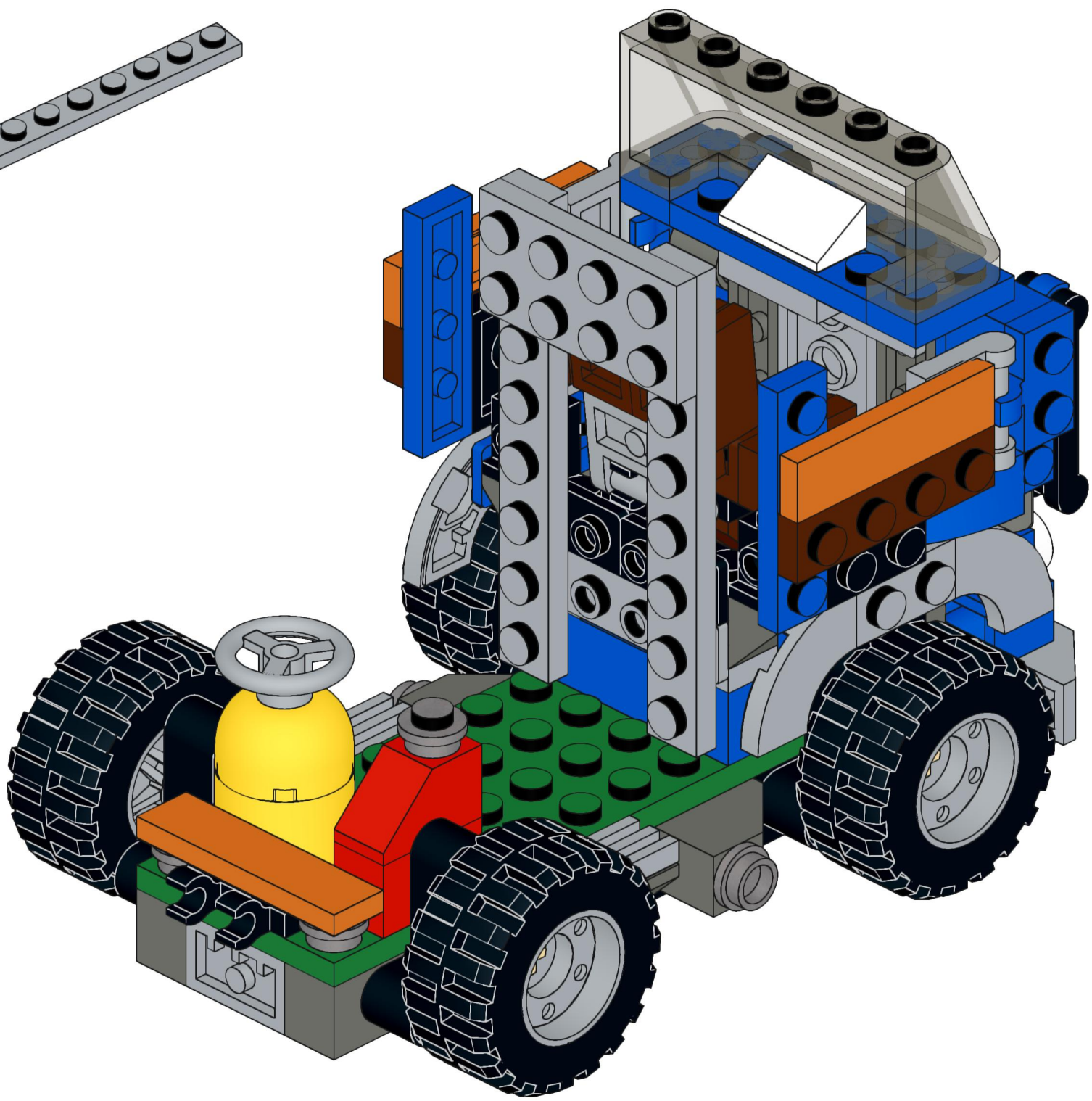

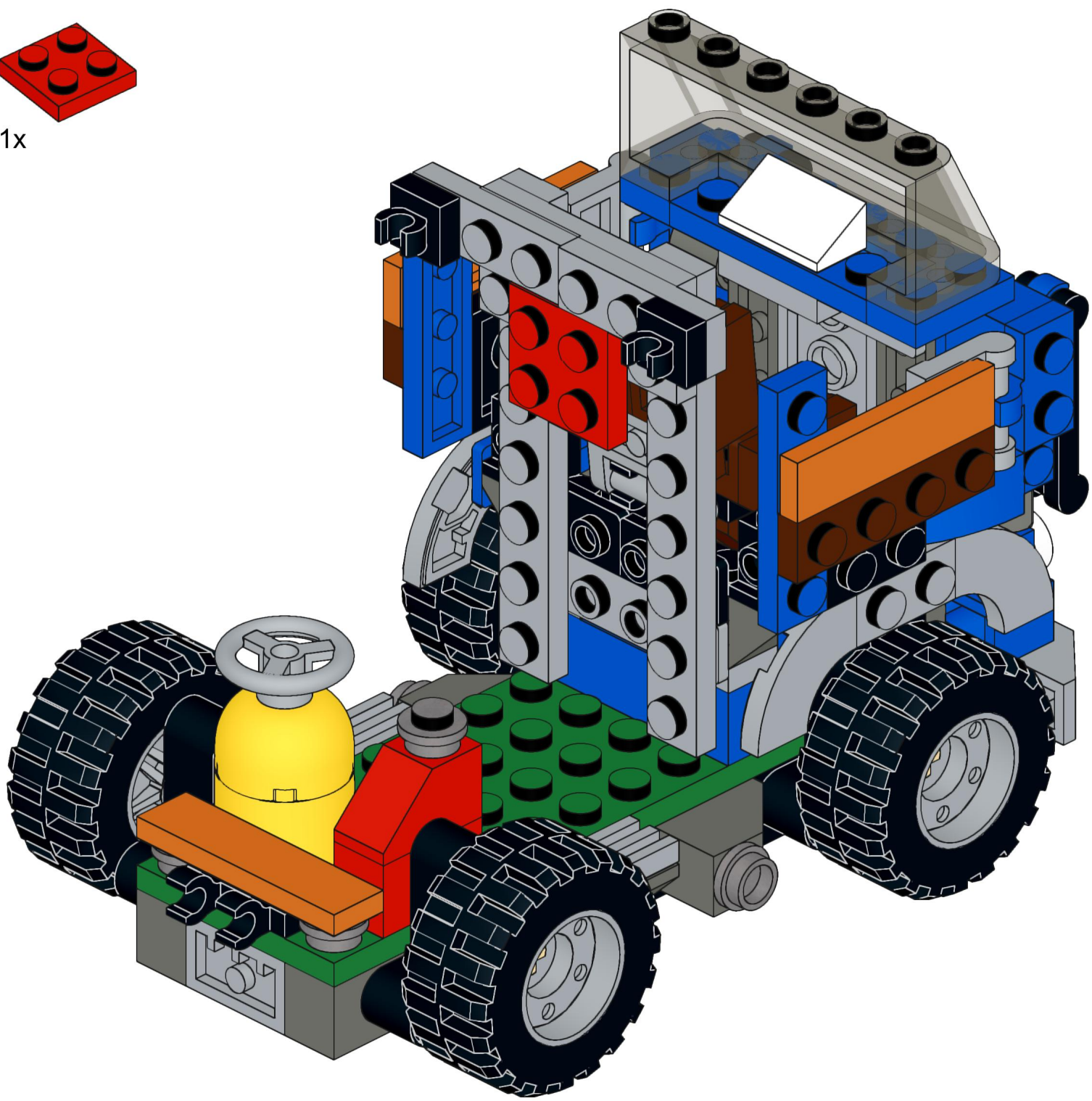
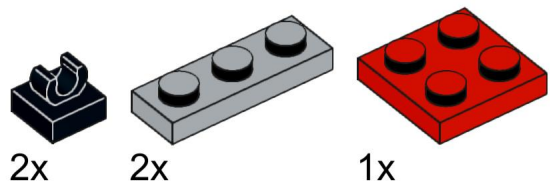



2x

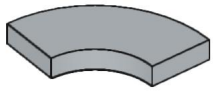

2x



1x

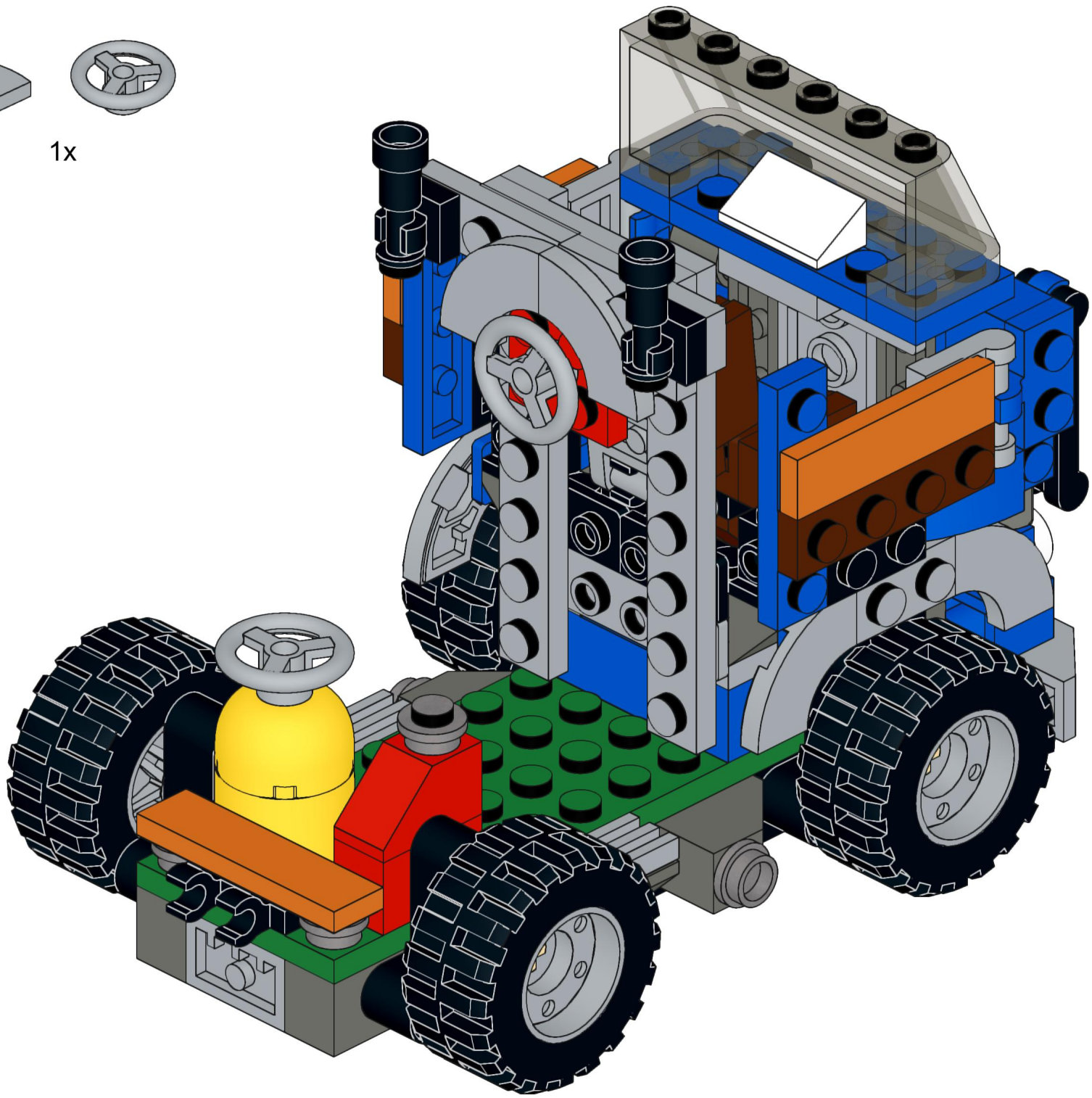

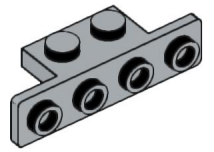

1x

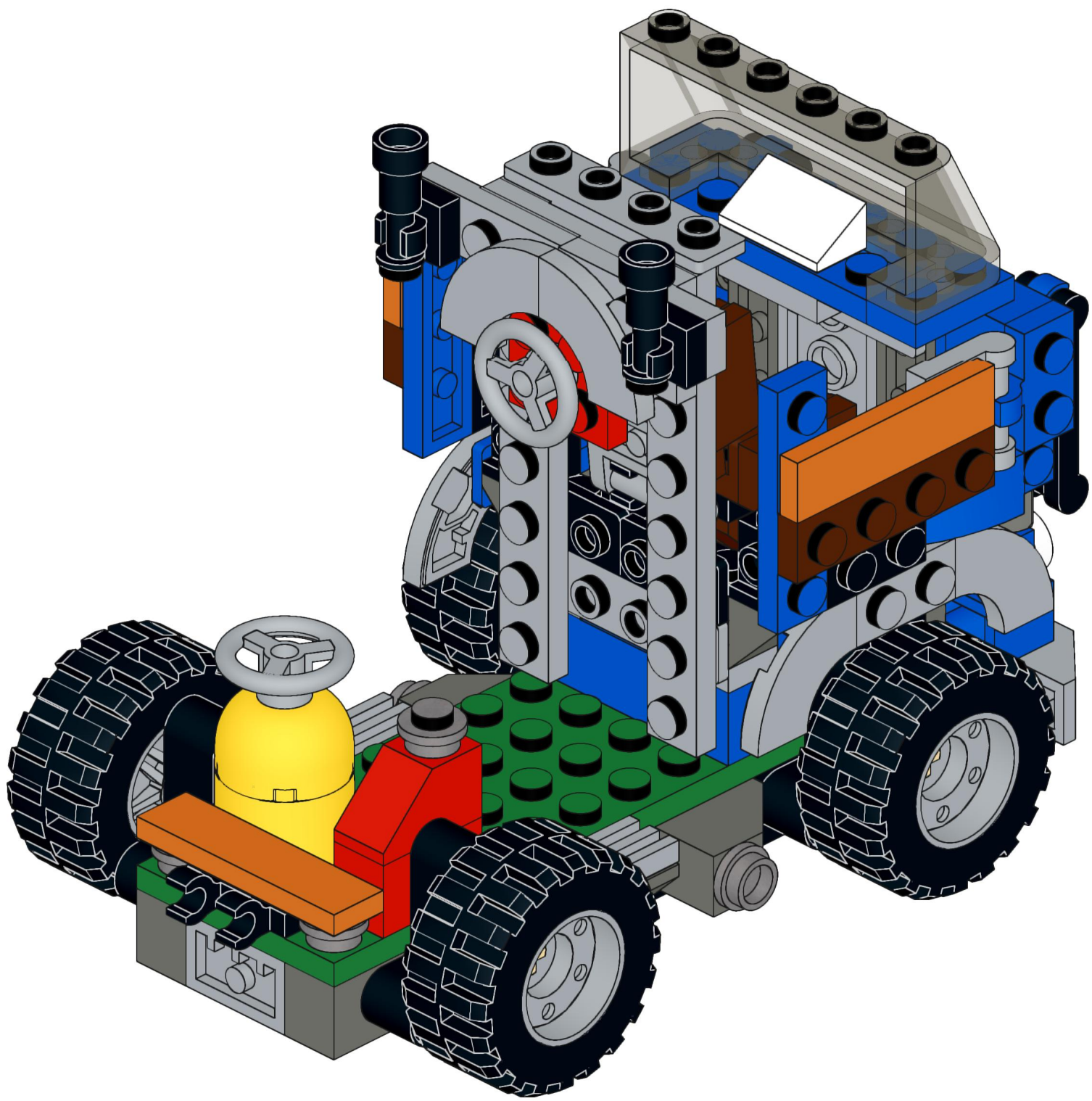

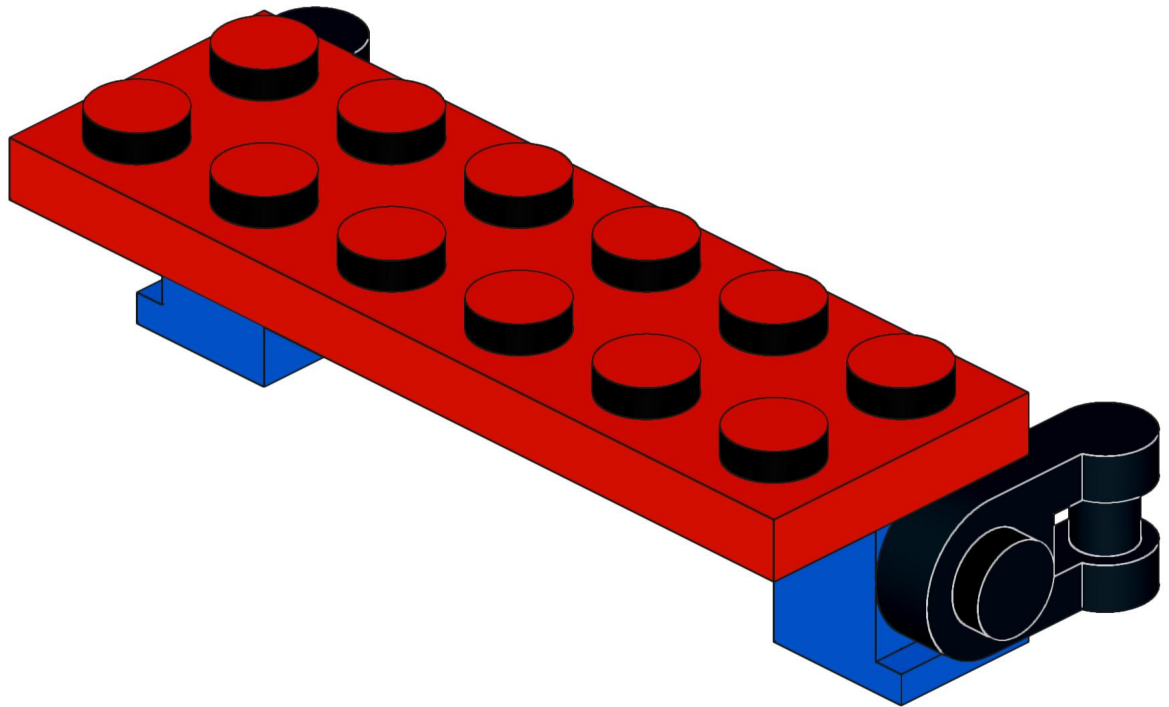
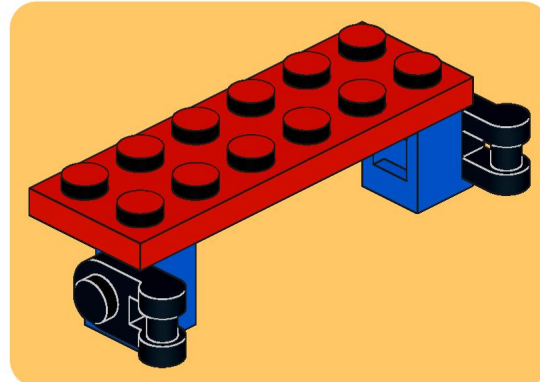
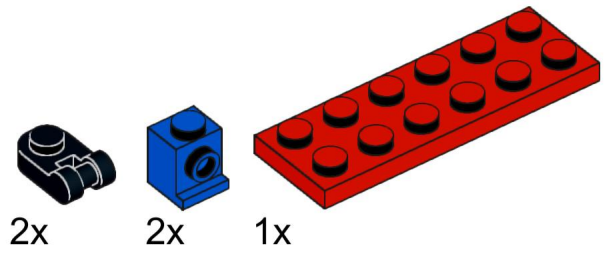

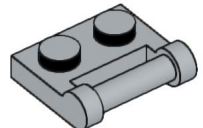
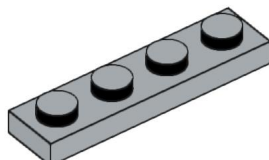
- 2x 
- 1x 
- 1x 

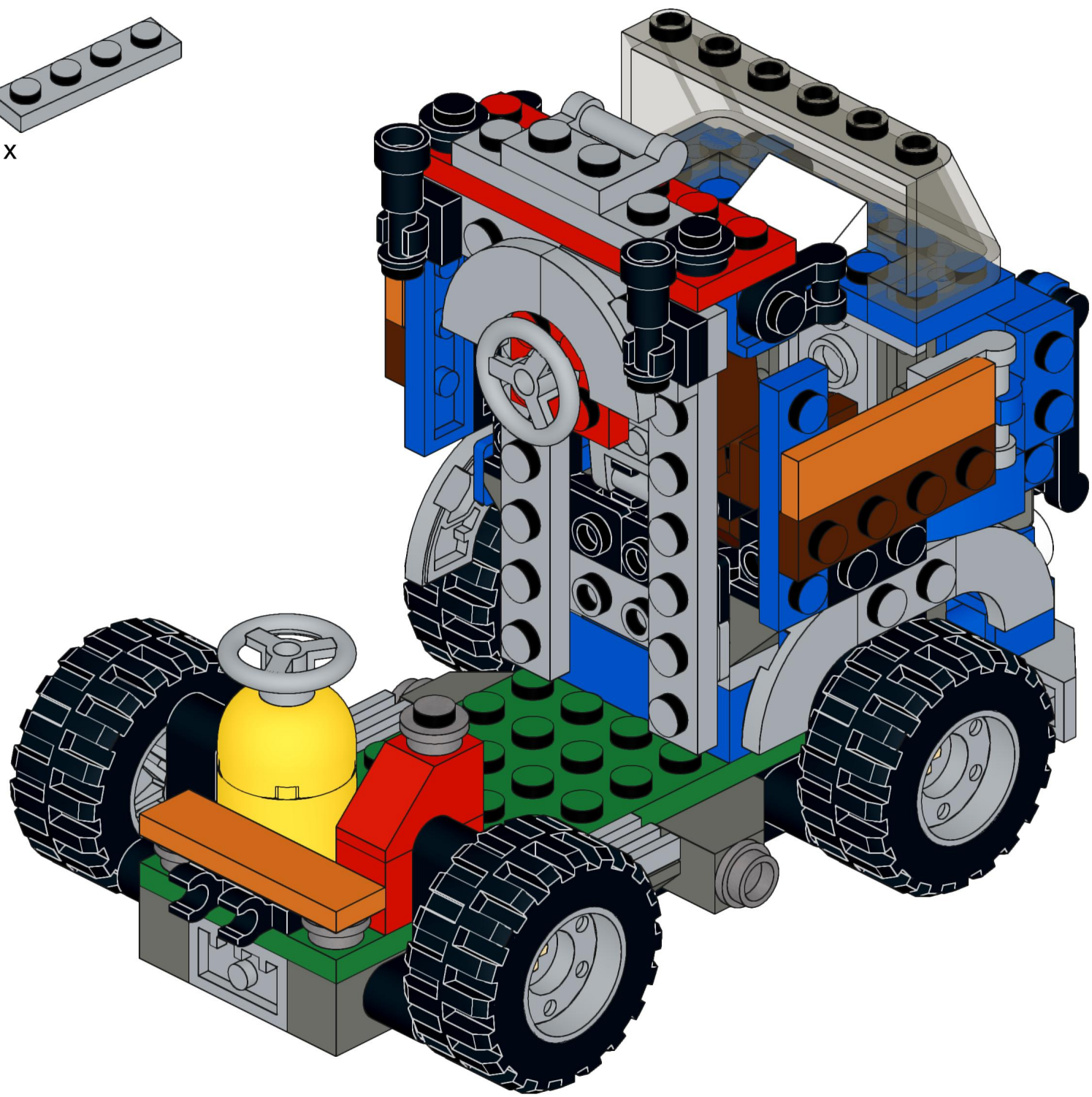

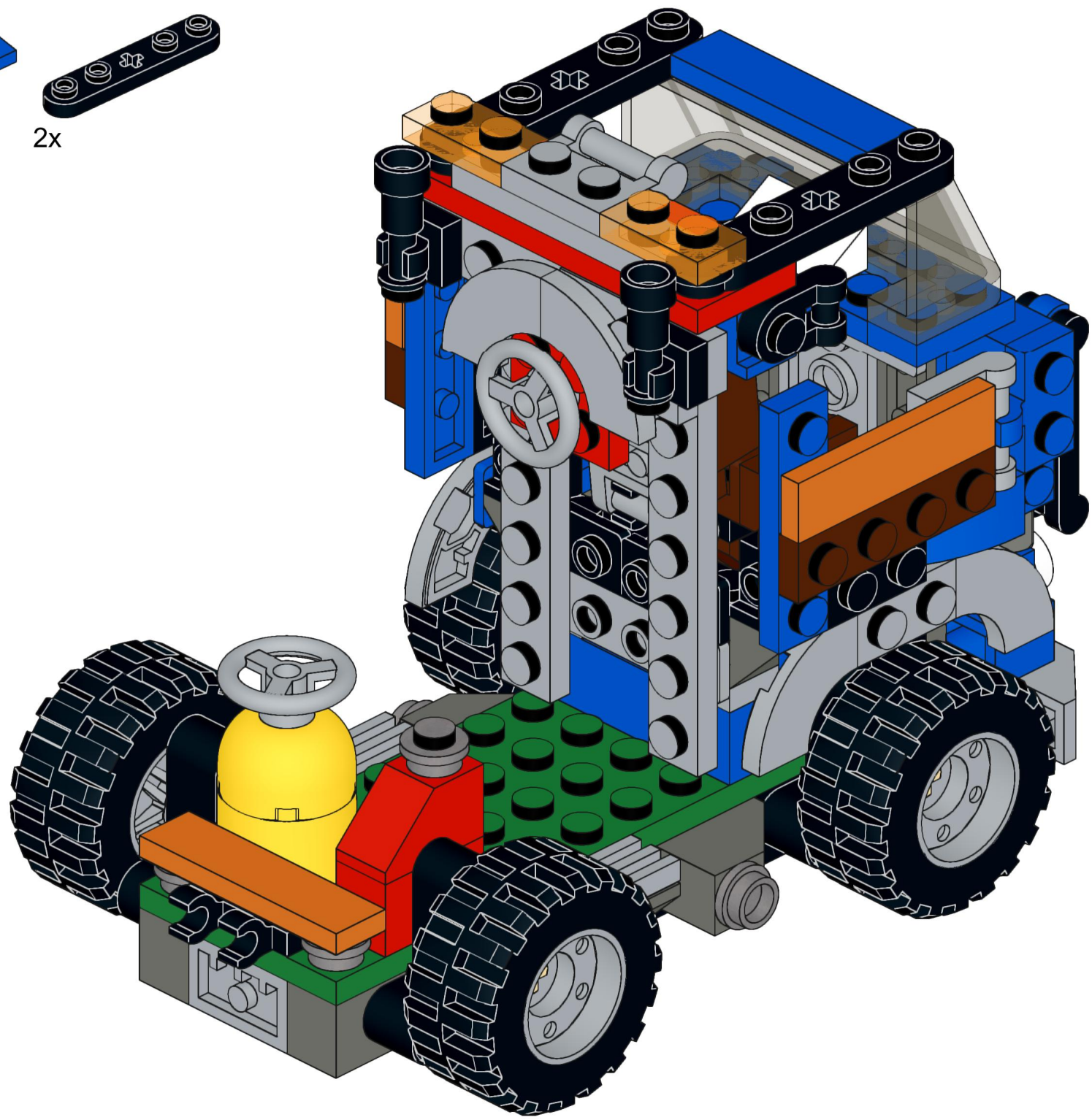
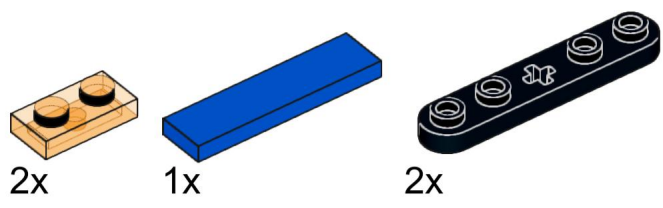

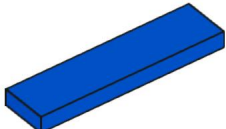
-  2x
-  3x

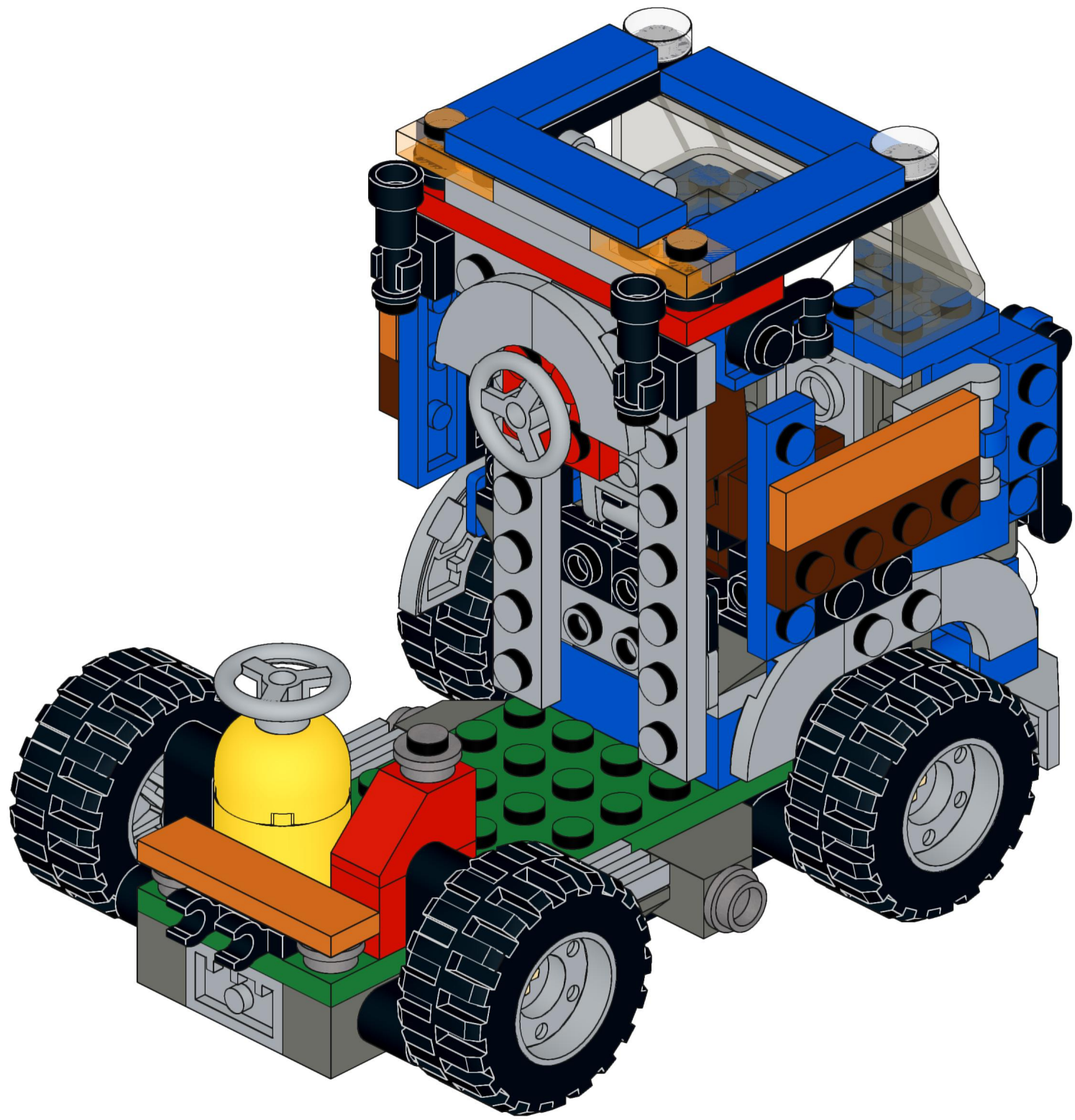



2x

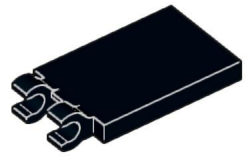

1x

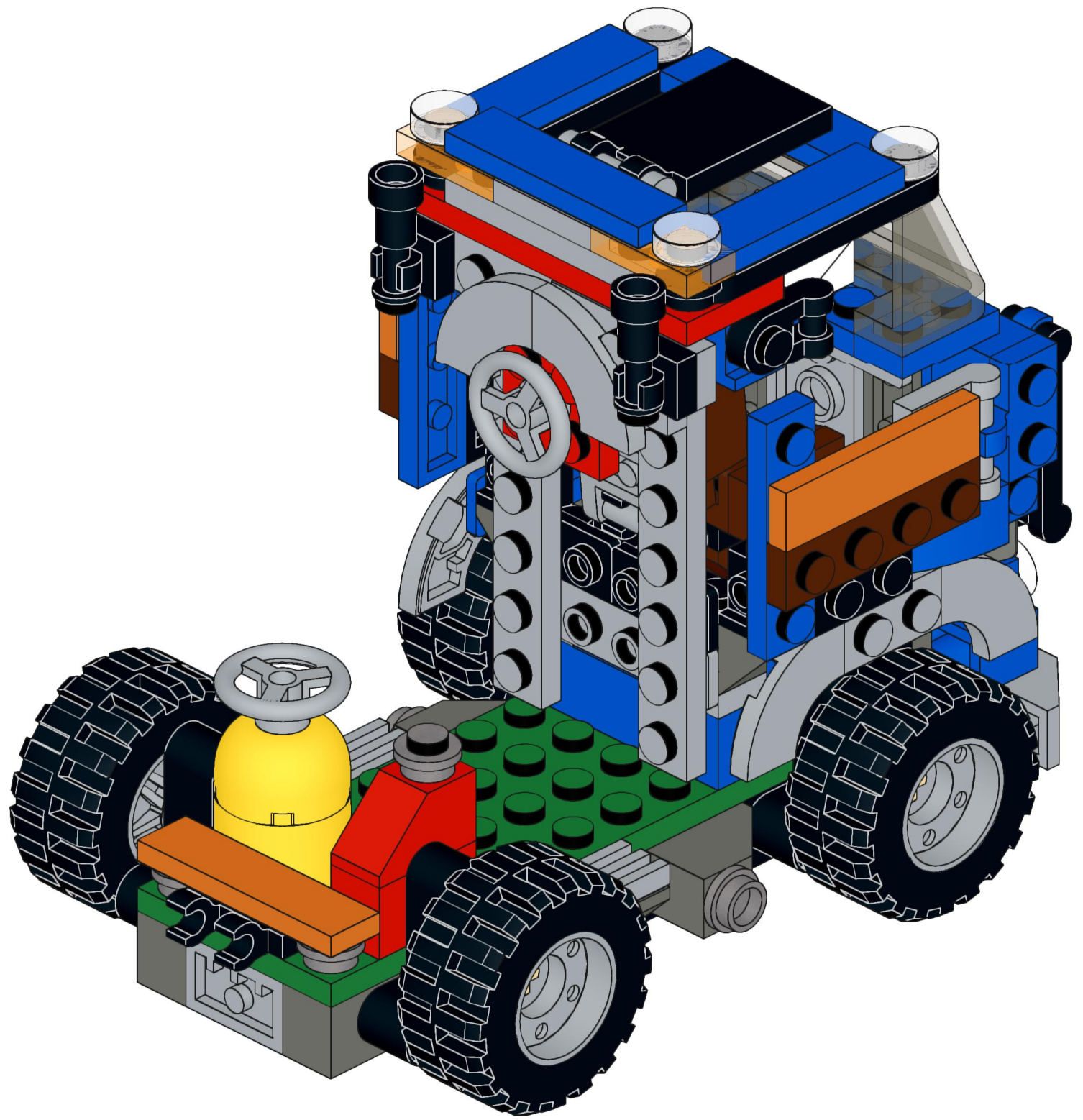

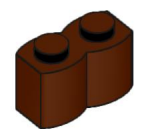

2x

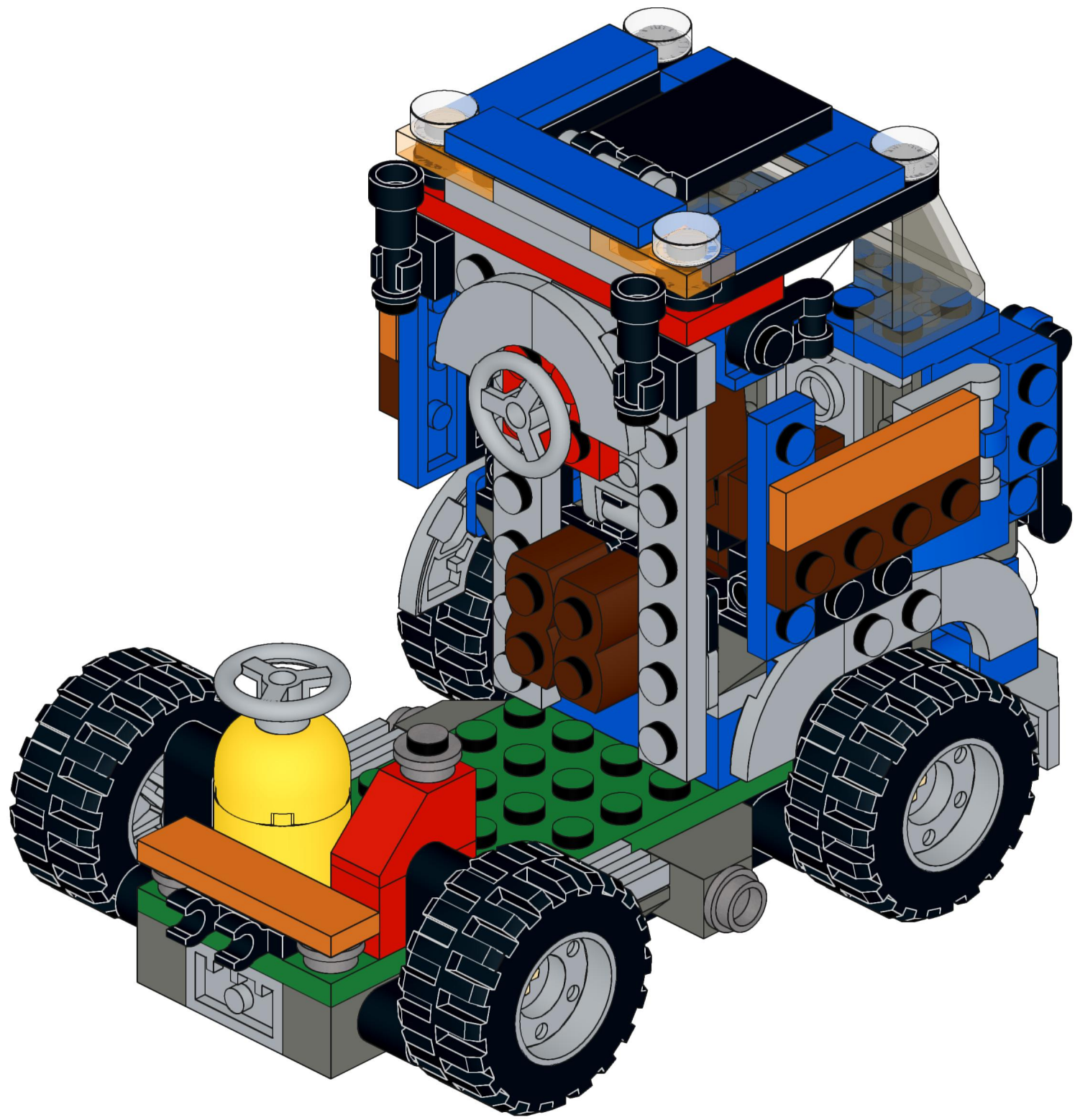



1x



1x

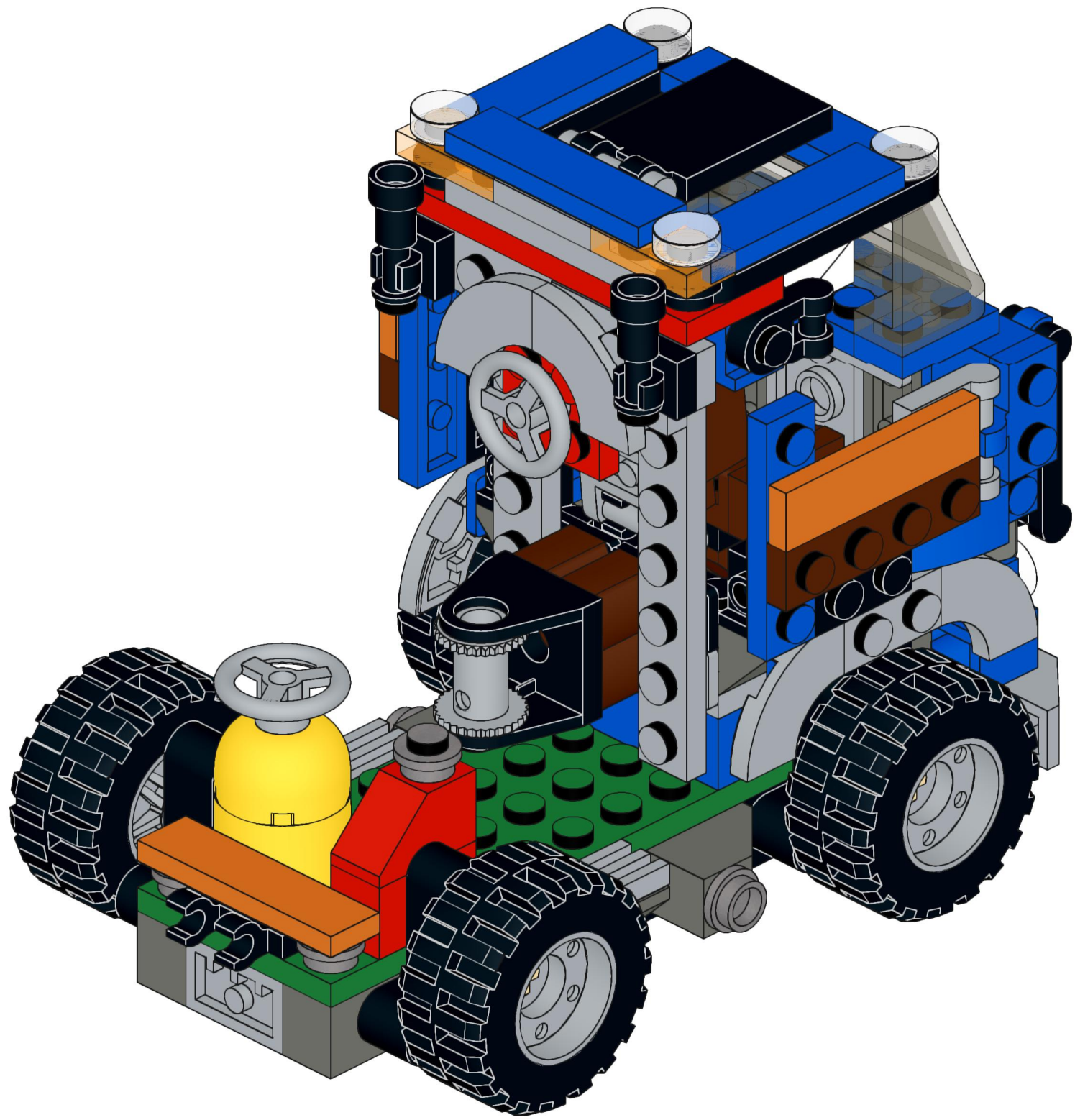



1x

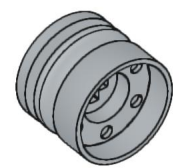

1x



1x

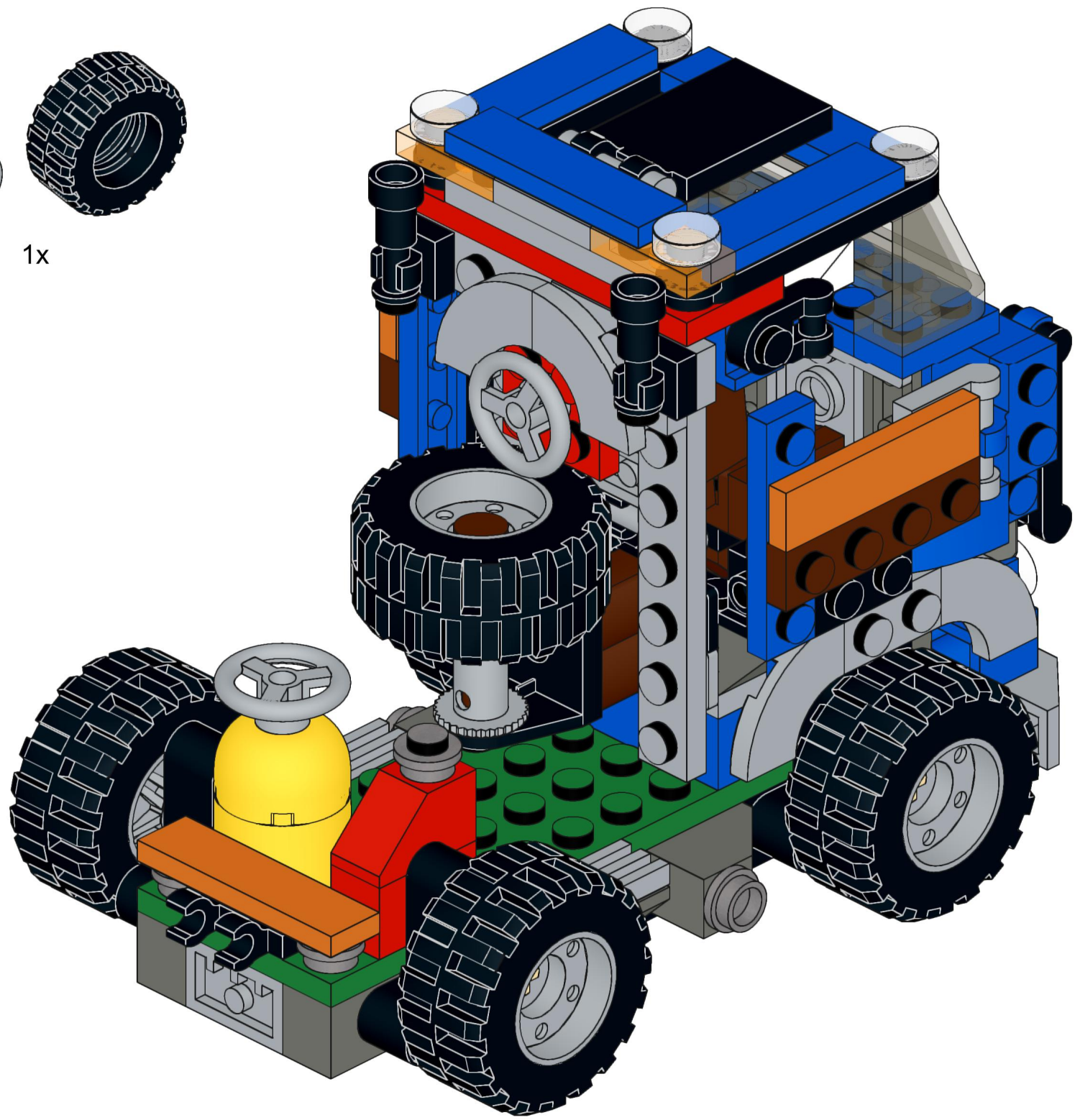

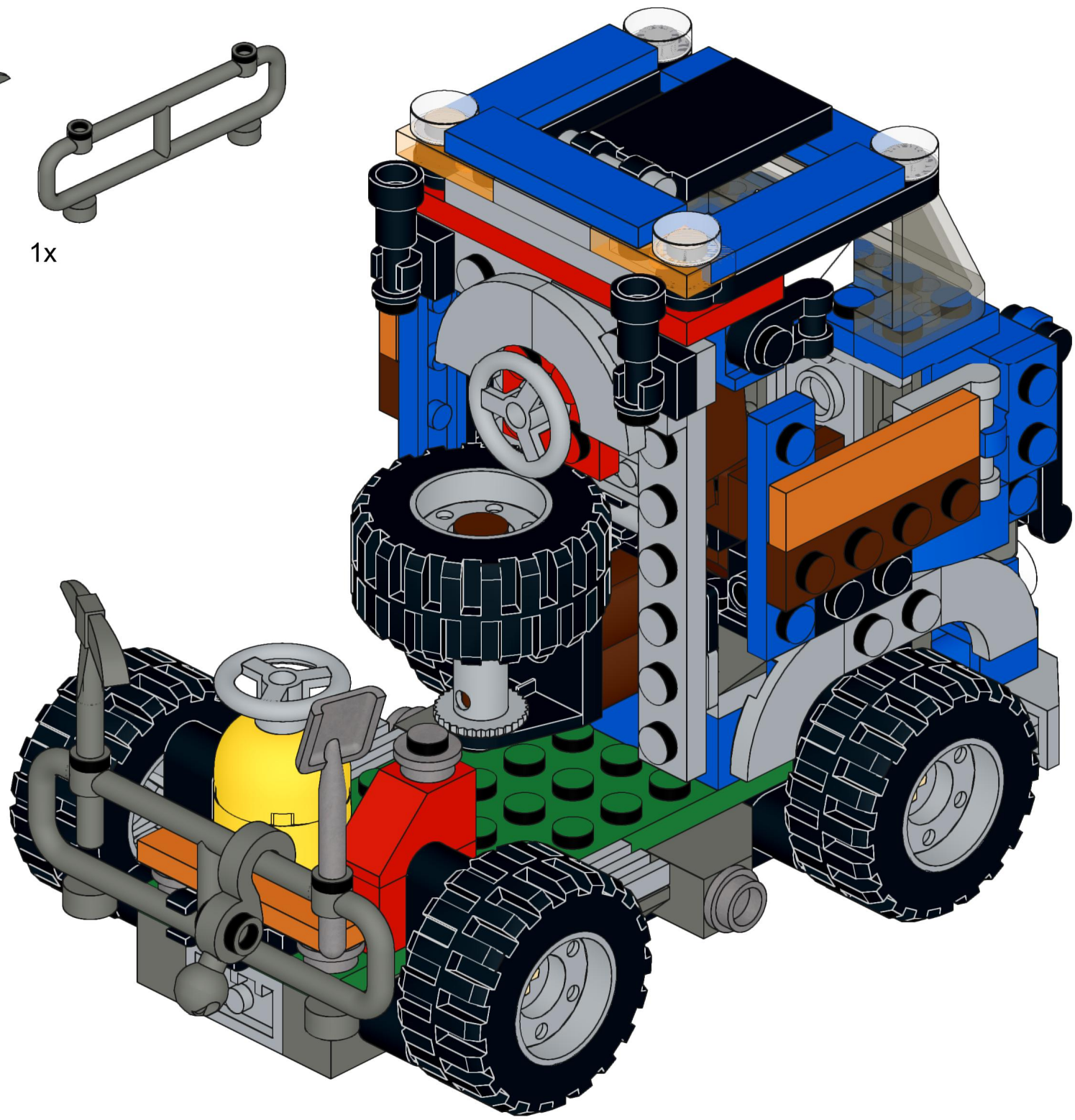
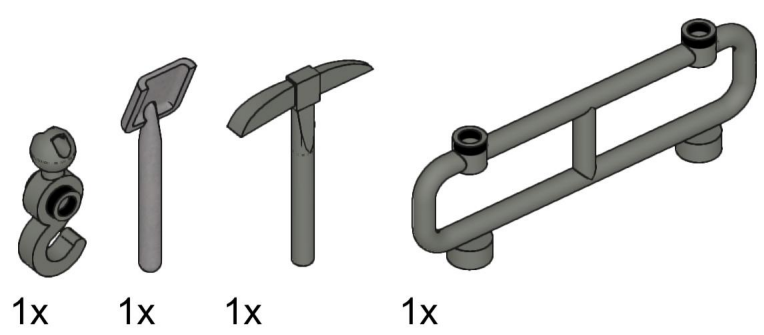

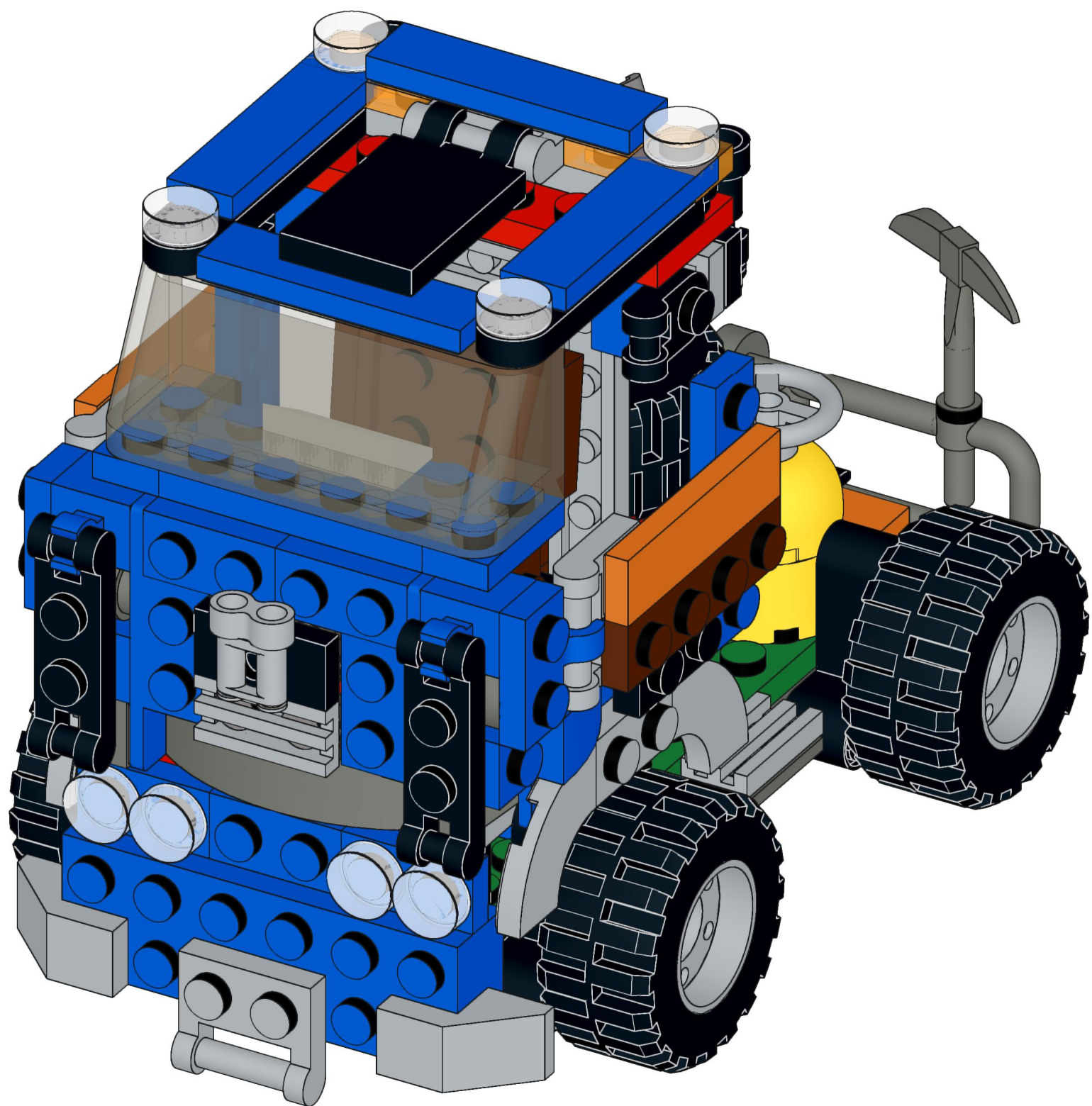

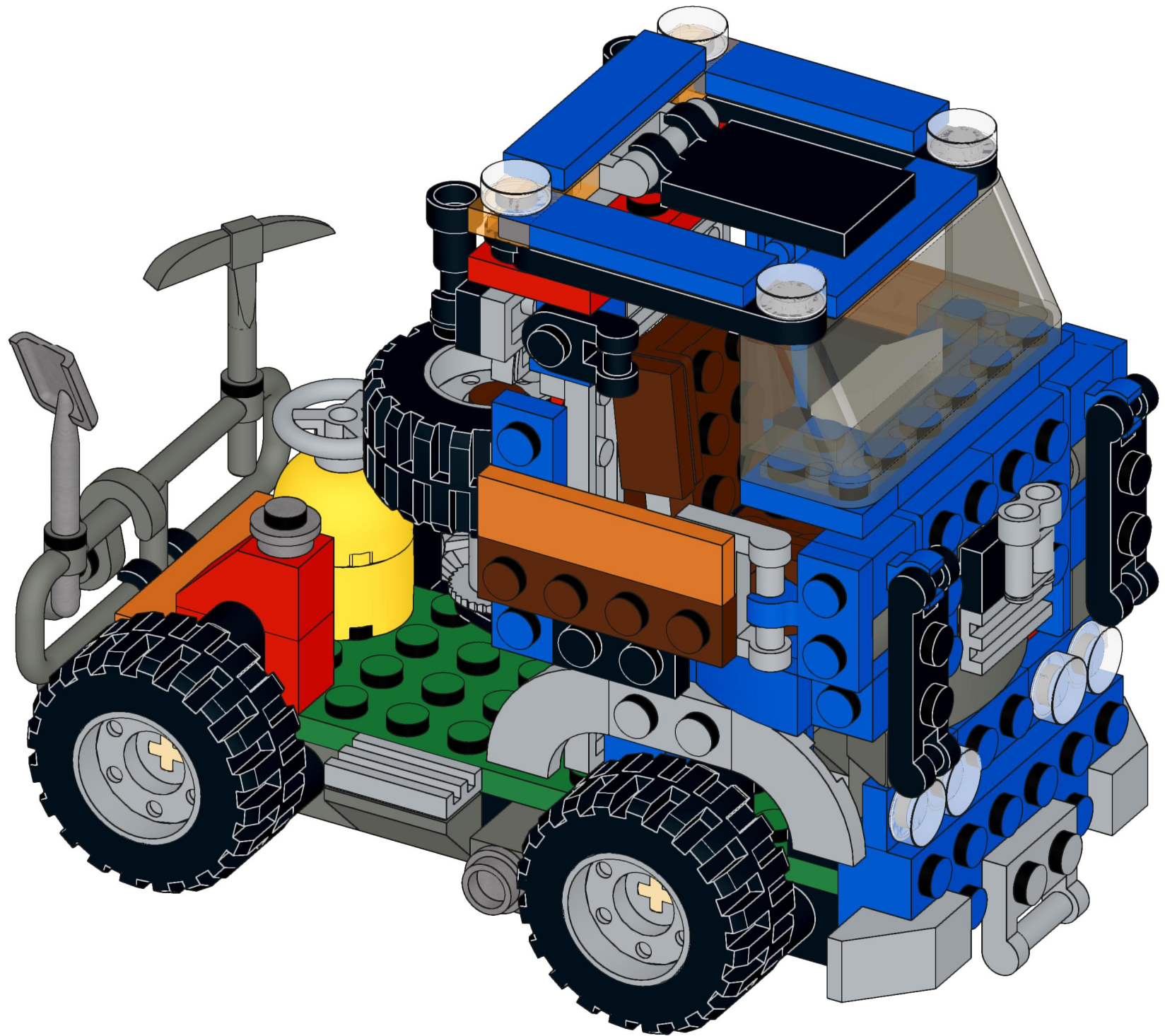

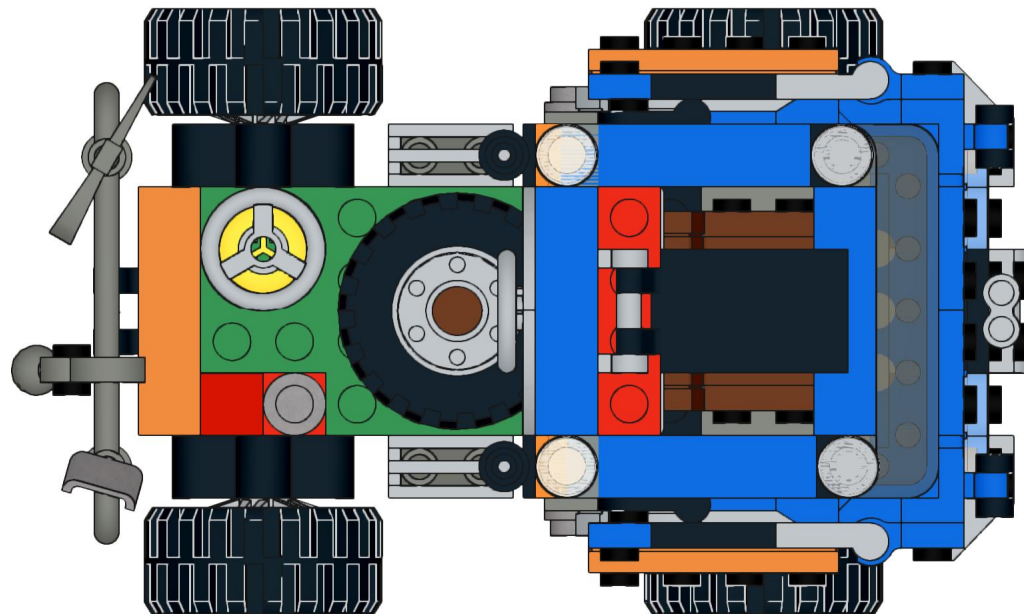
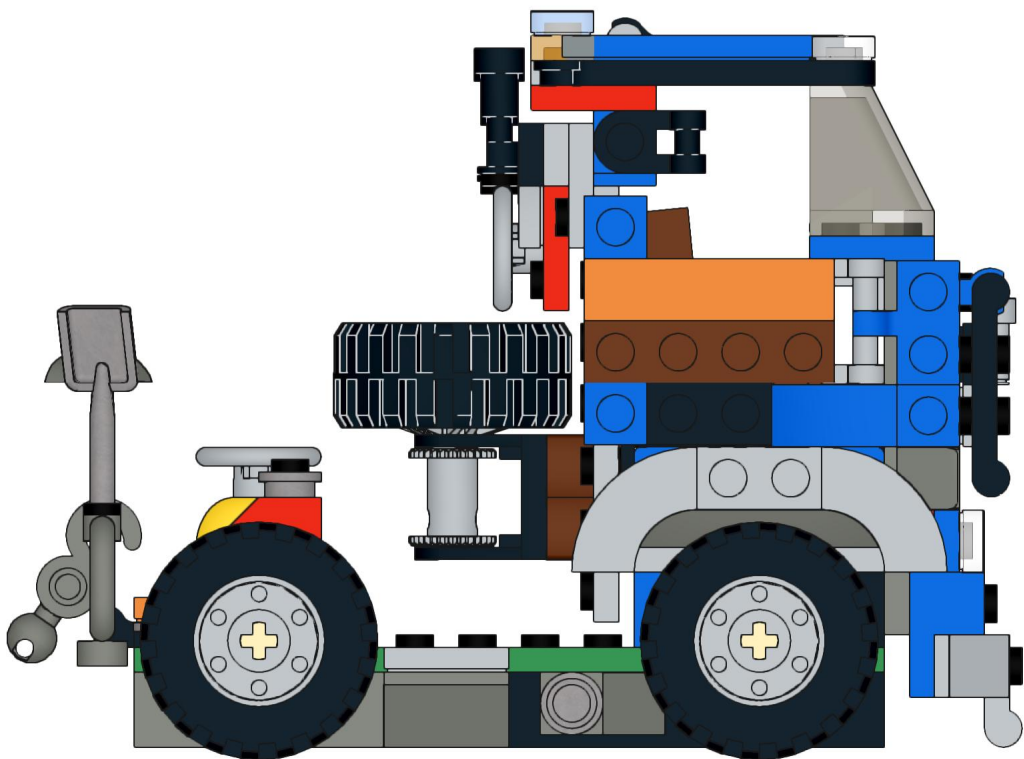
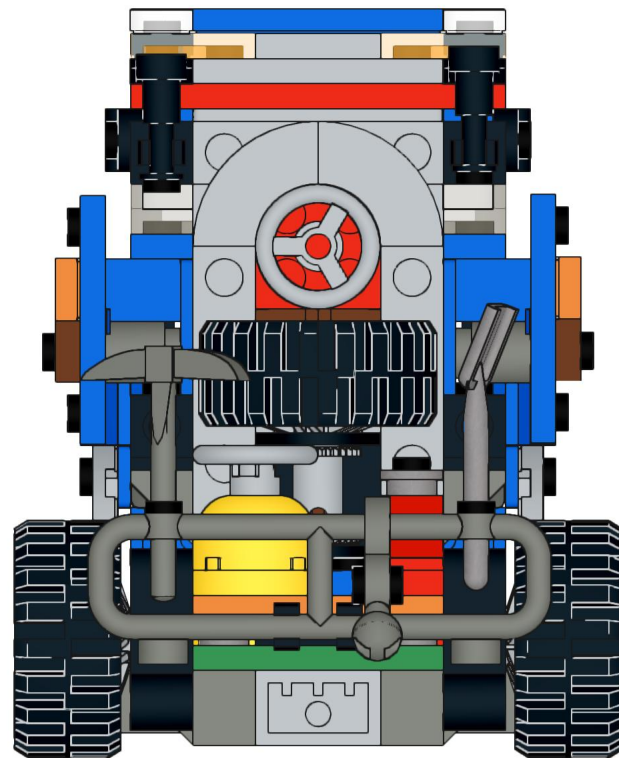
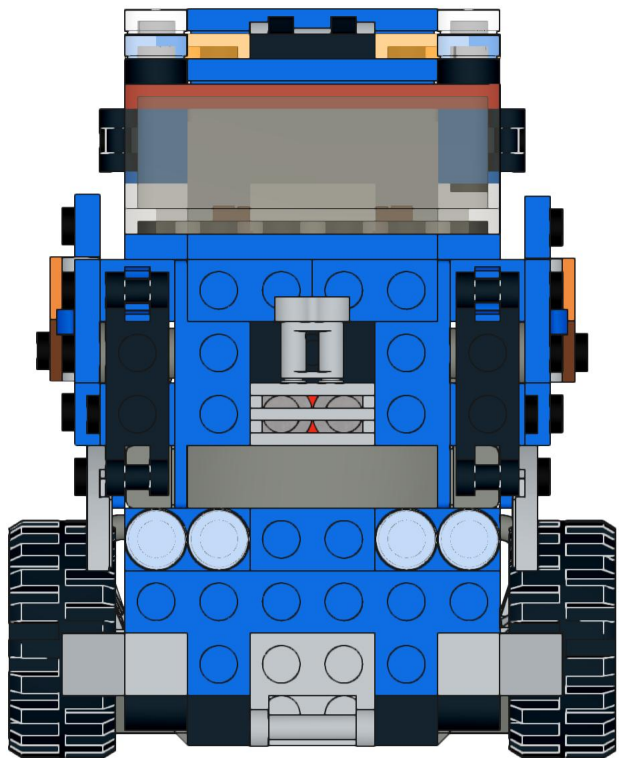

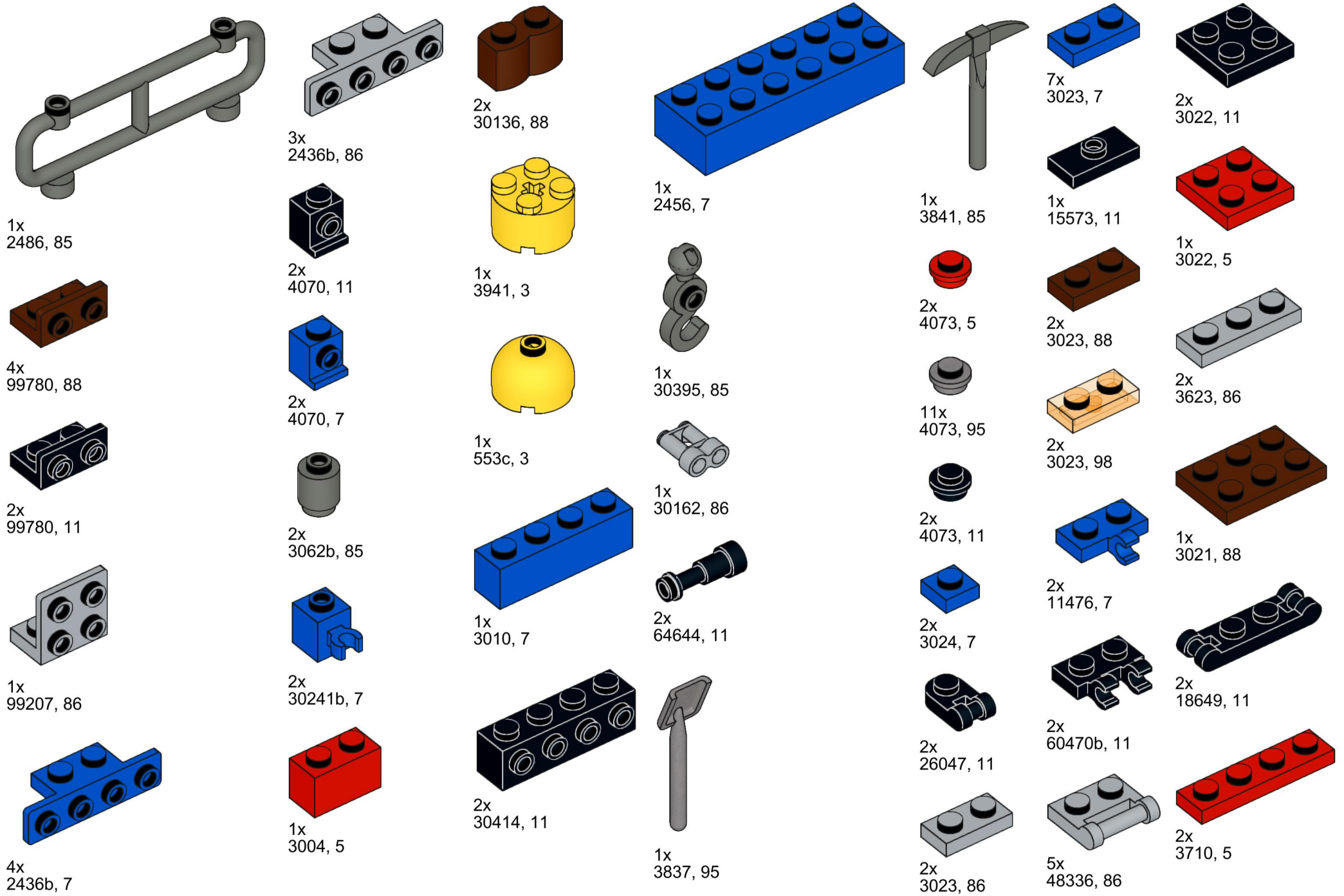

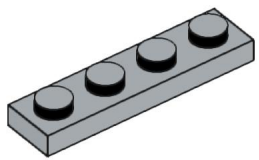

3x
3710, 86

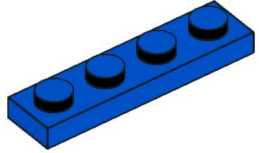

2x
3710, 7

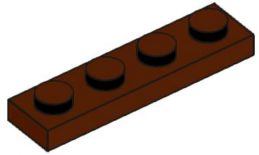

4x
3710, 88

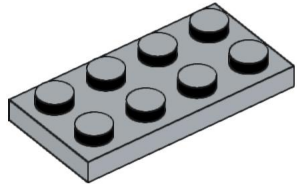

1x
3020, 86

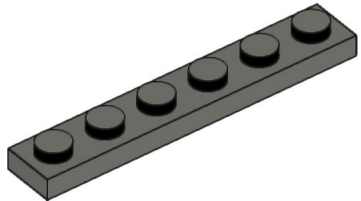

2x
3666, 85

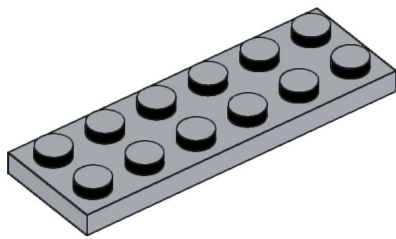

1x
3795, 86

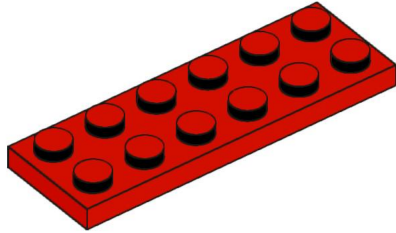

1x
3795, 5

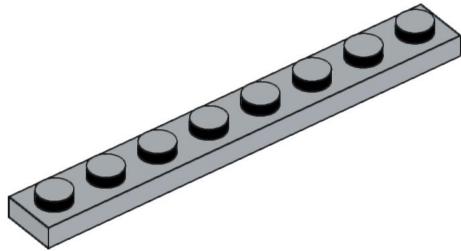

2x
3460, 86

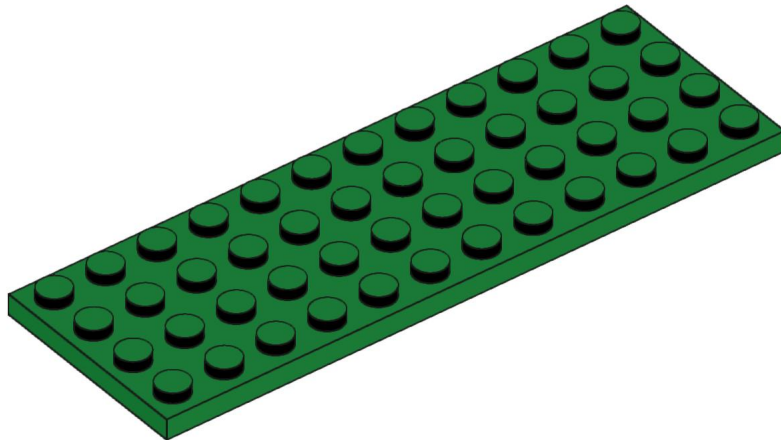

1x
3029, 6



2x
54200, 85

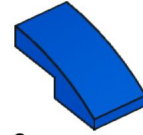

2x
11477, 7

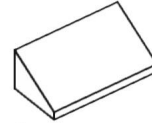

1x
85984, 1

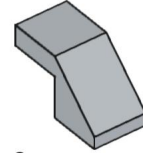

2x
28192, 86

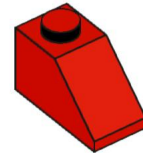

1x
3040, 5

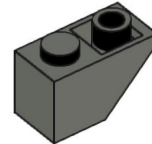

2x
3665, 85

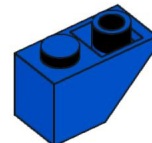

2x
3665, 7

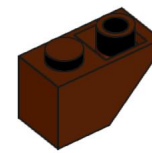

2x
3665, 88

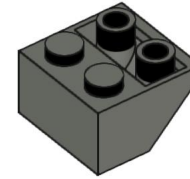

2x
3660, 85

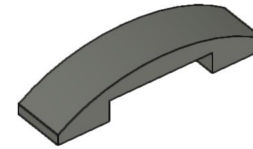

1x
93273, 85

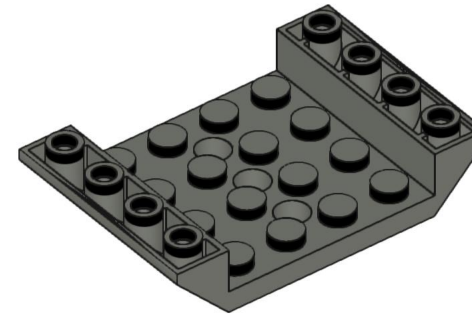

1x
60219, 85

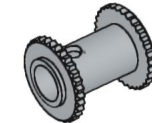

1x
2585, 86

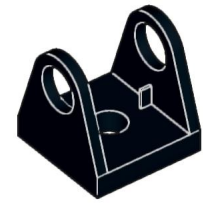

1x
2584, 11



8x
2780, 11

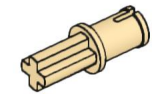

4x
3749, 2

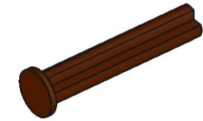

1x
24316, 88



4x
60484, 11

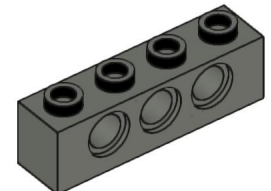

2x
3701, 85

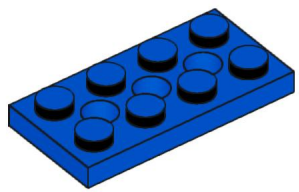

1x
3709b, 7

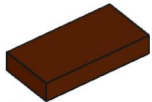

2x
3069b, 88



2x
30663, 86

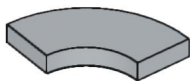

6x
27925, 86

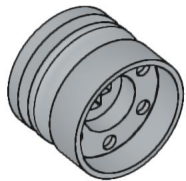

5x
55982, 86

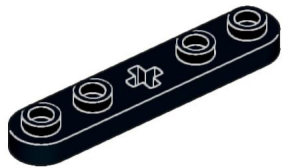

2x
32124, 11

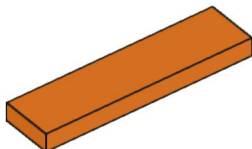

3x
2431, 150

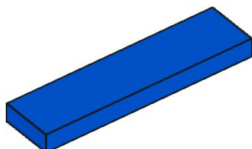

4x
2431, 7

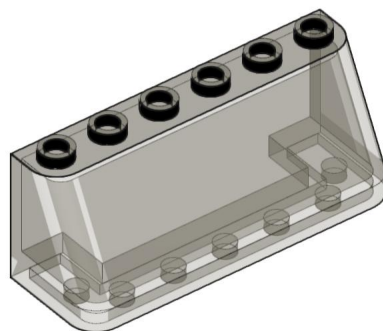

2x
3894, 11



8x
98138, 12

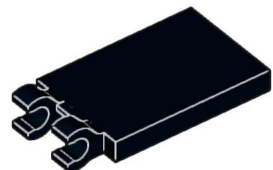

1x
4176, 13



2x
15712, 11

1x
30350b, 11

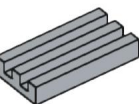

3x
2412b, 86



5x
92402, 11