

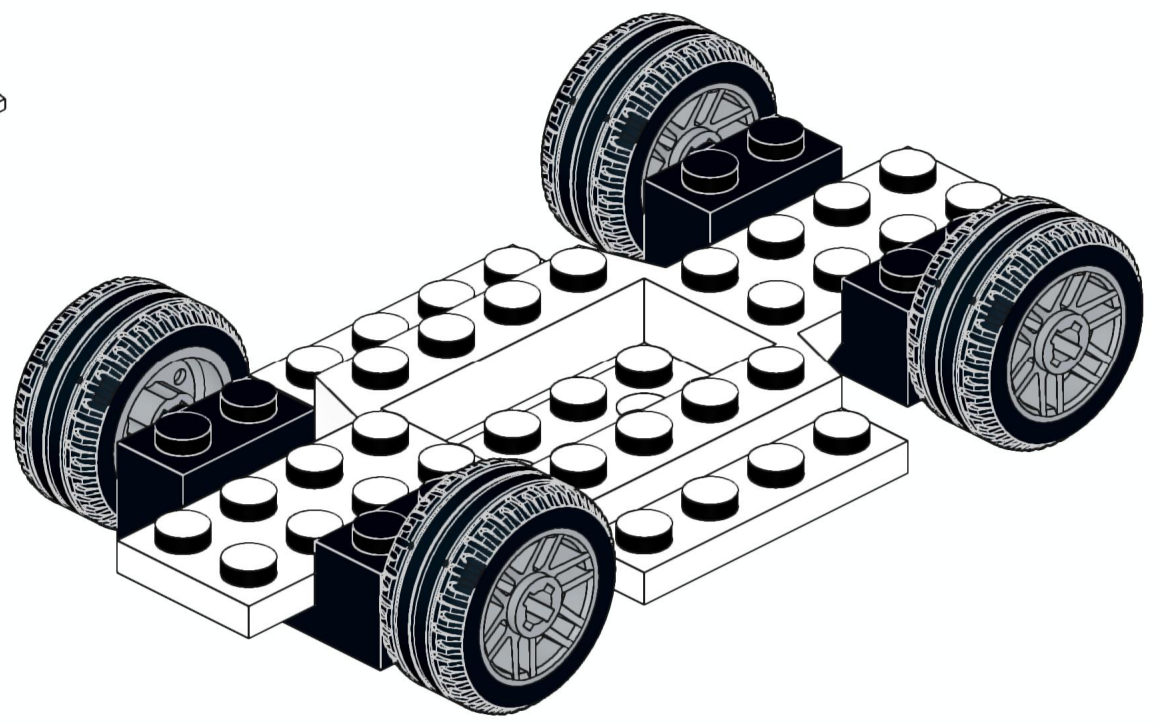

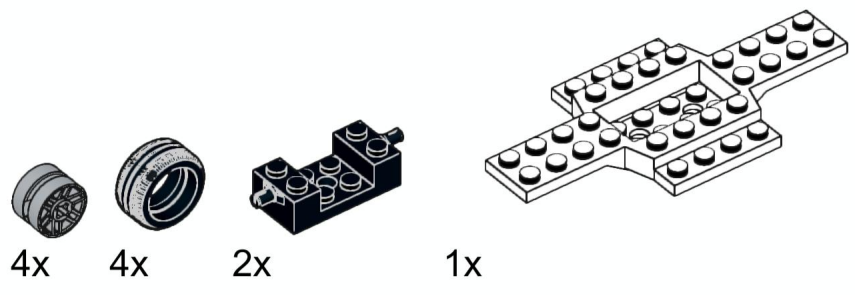

1



2

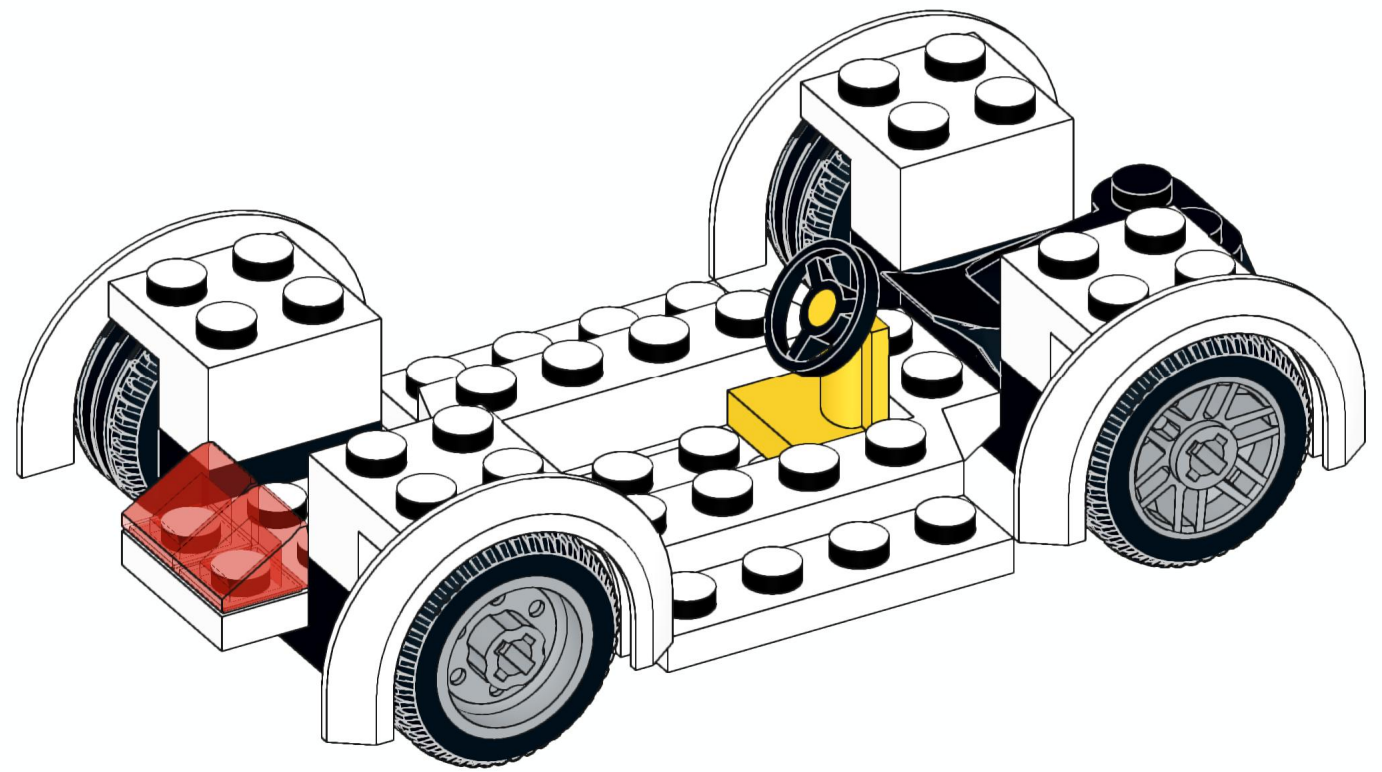
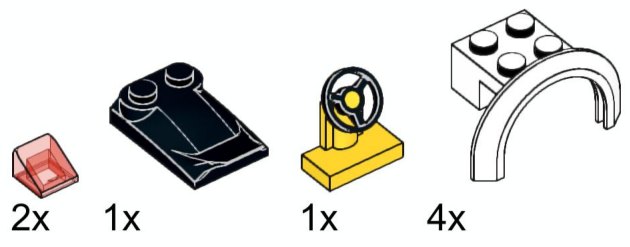

3

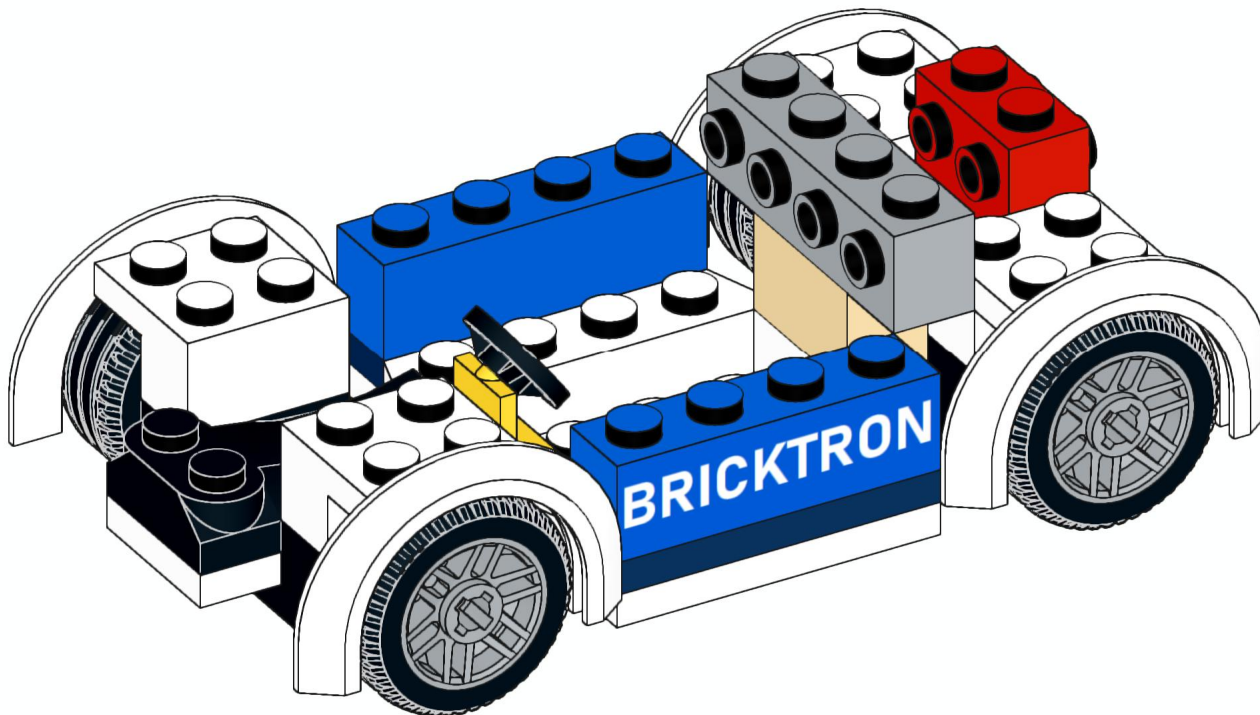
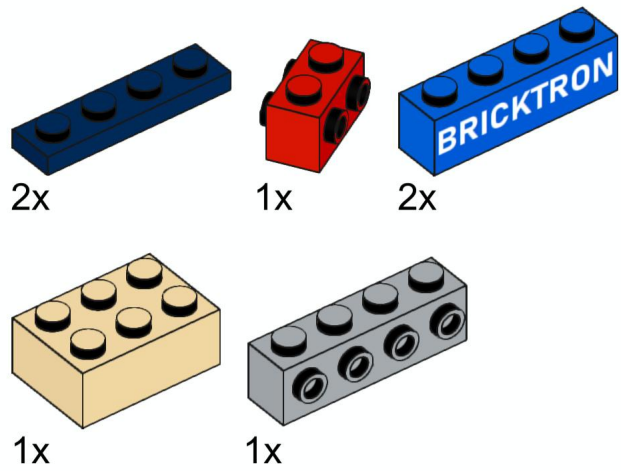

4

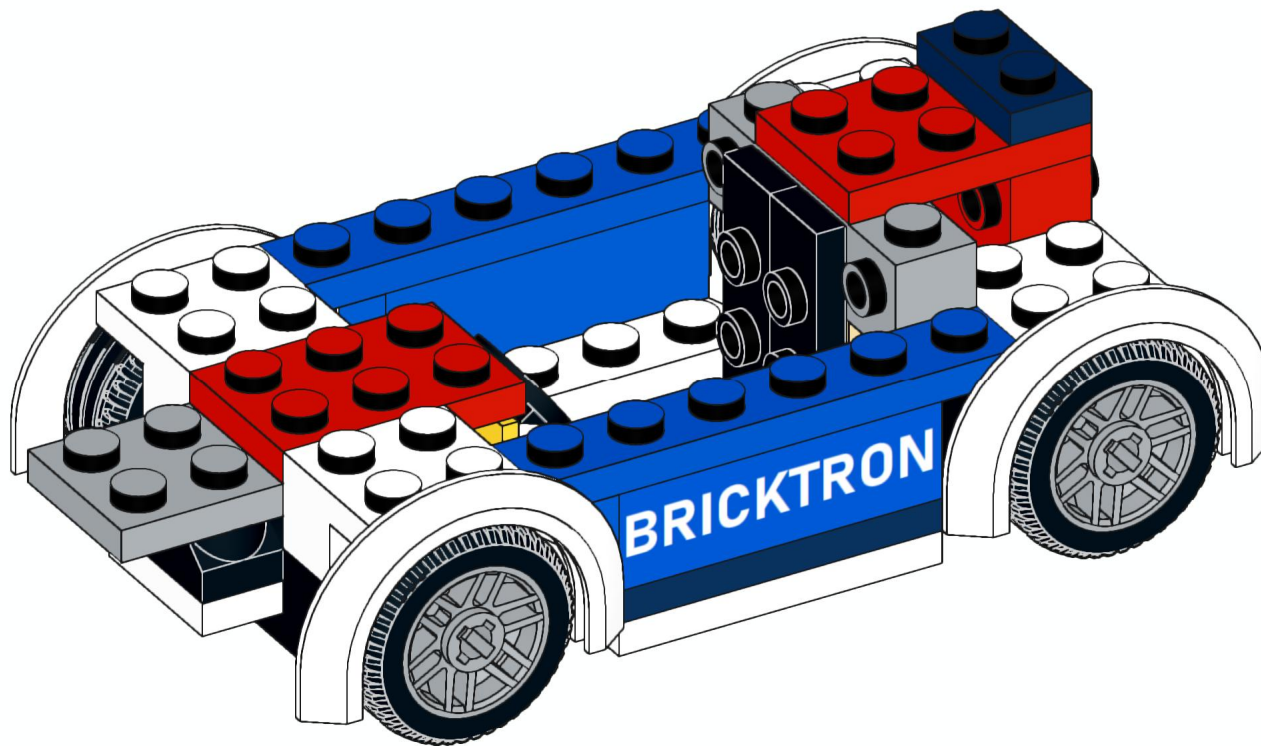
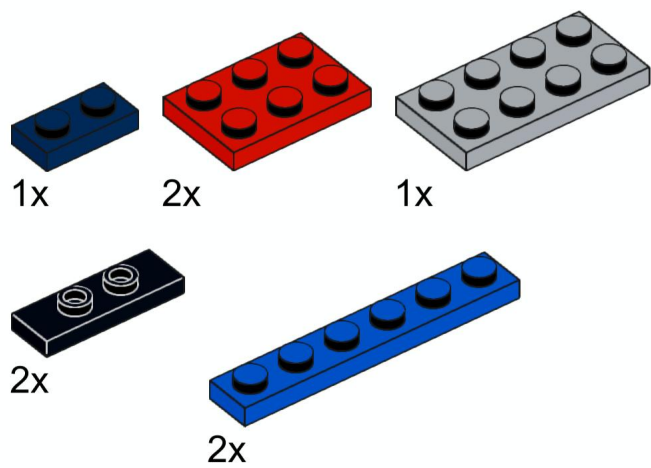

5

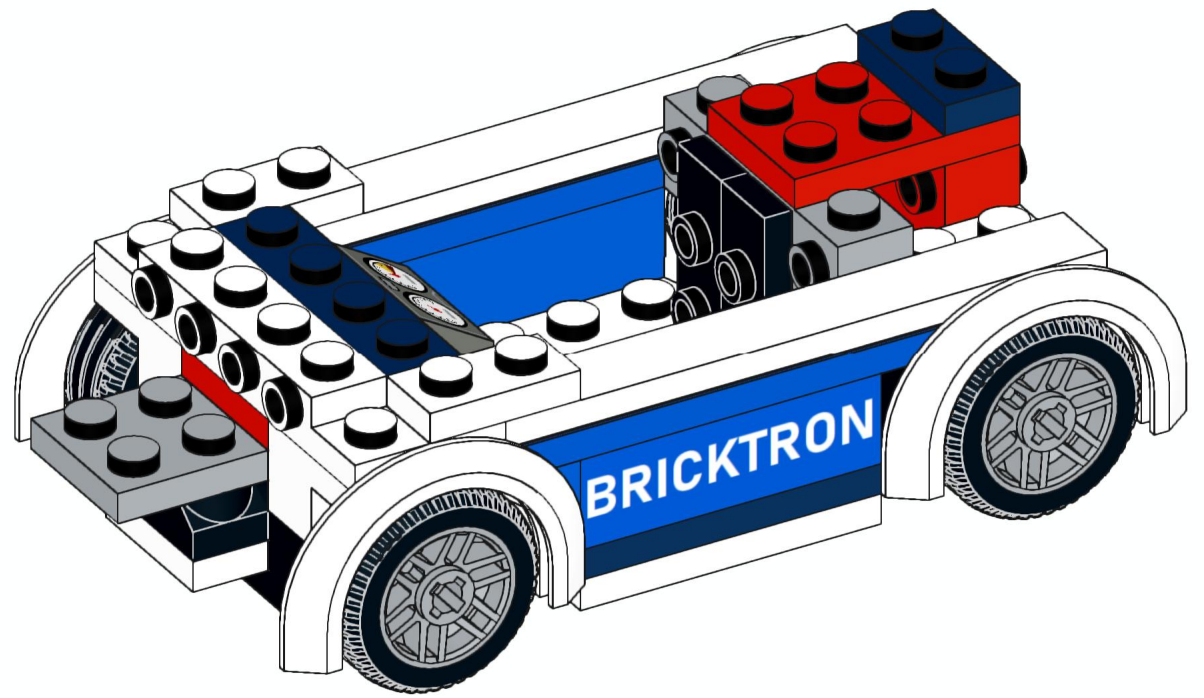
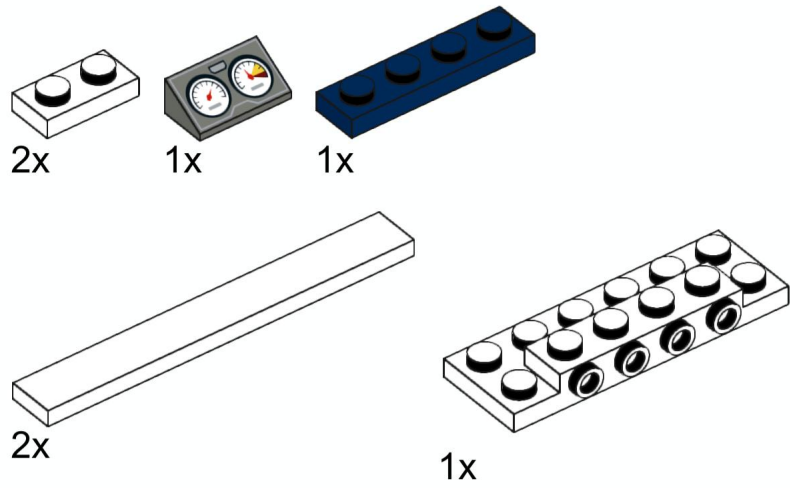

6

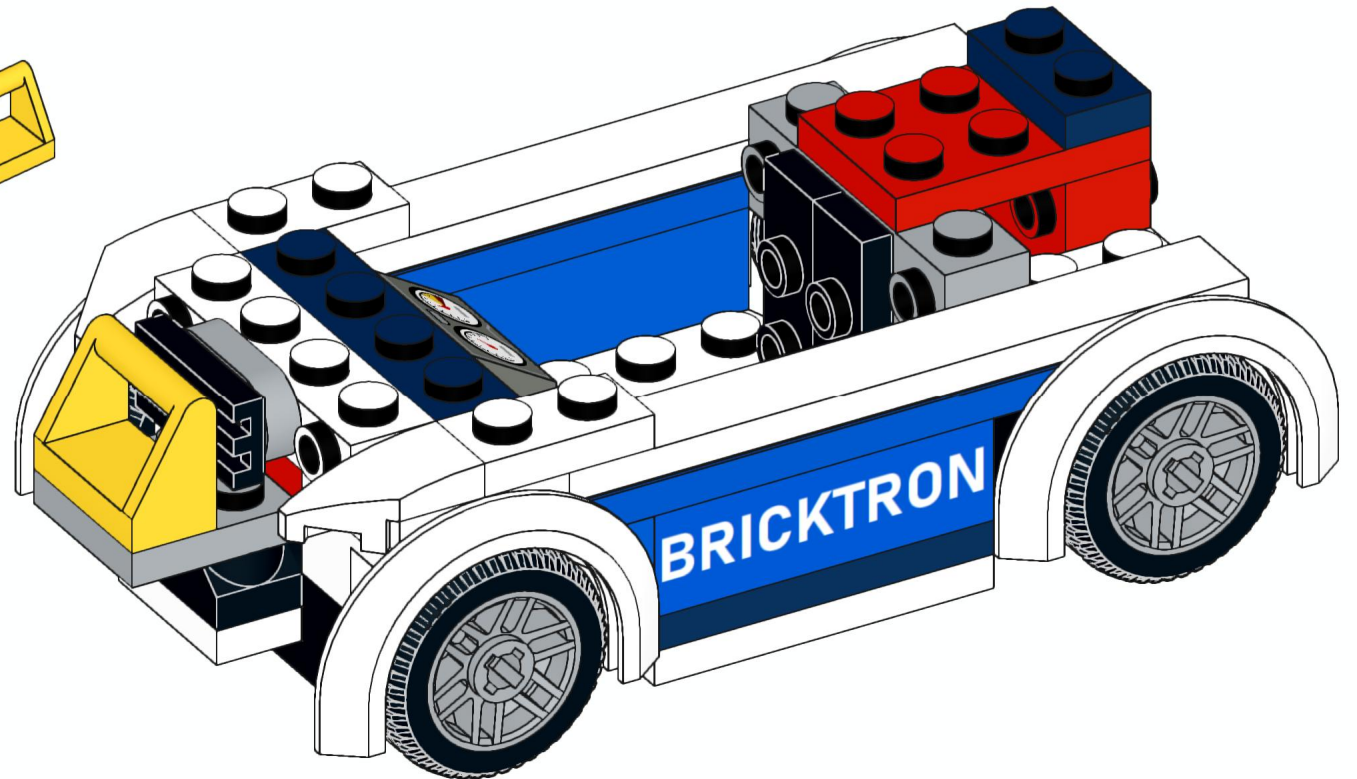
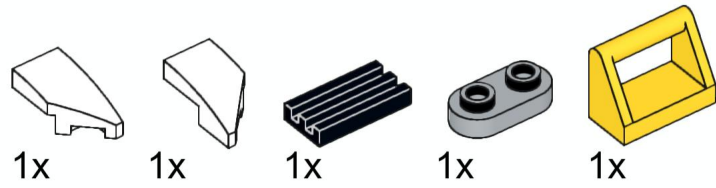



11

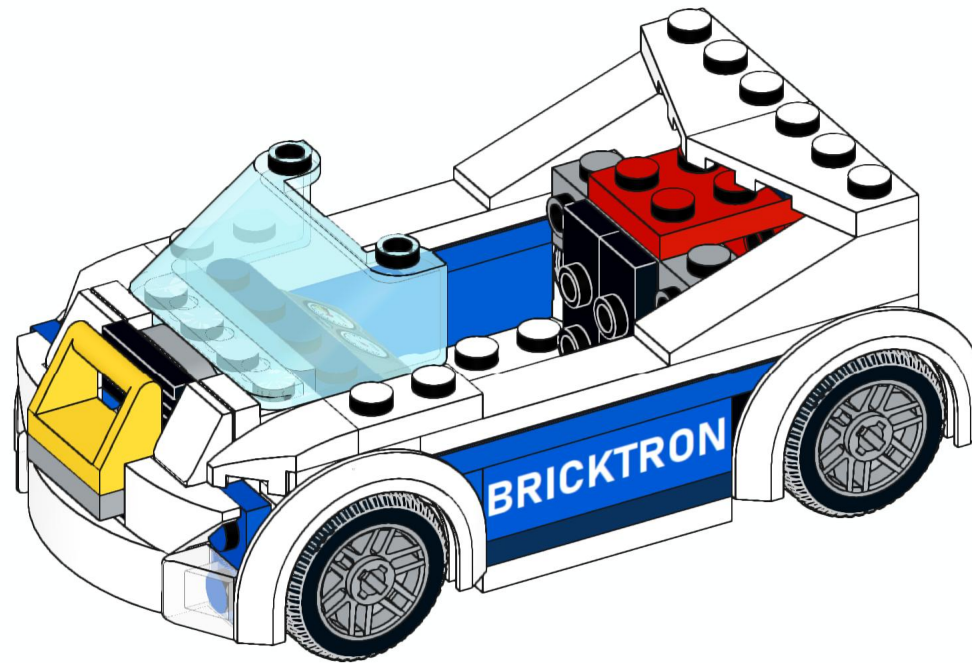
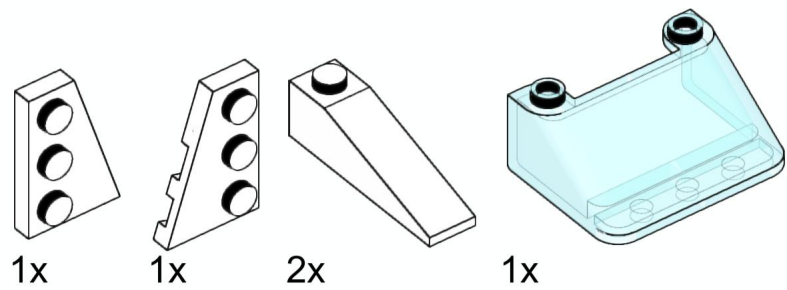

12

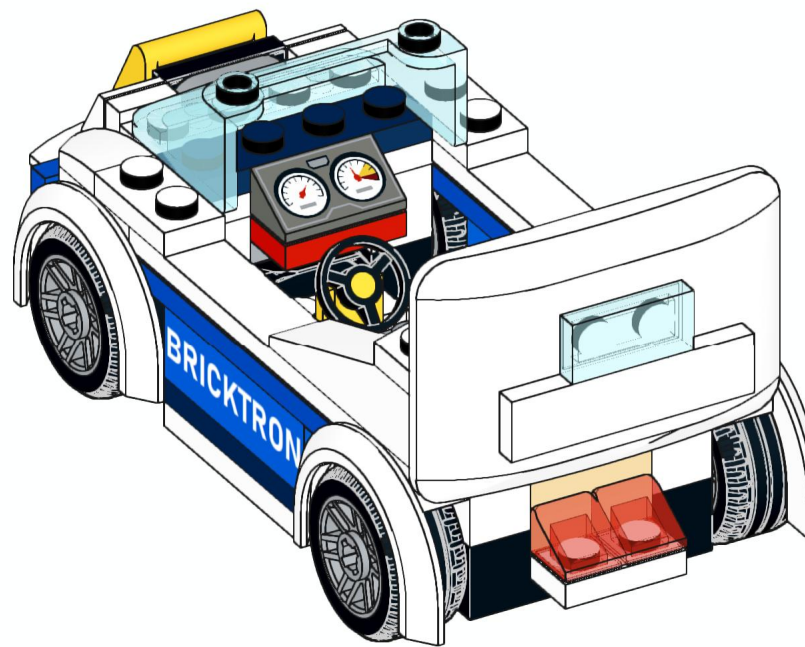
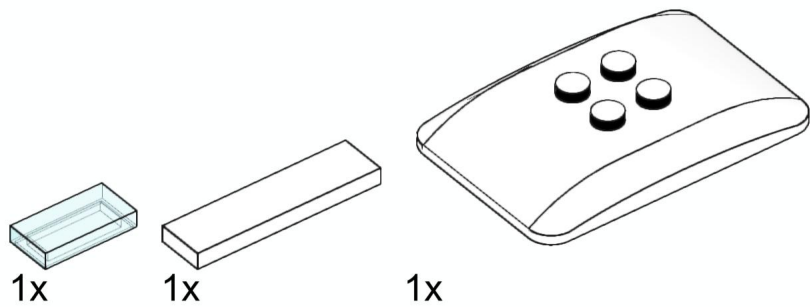

13

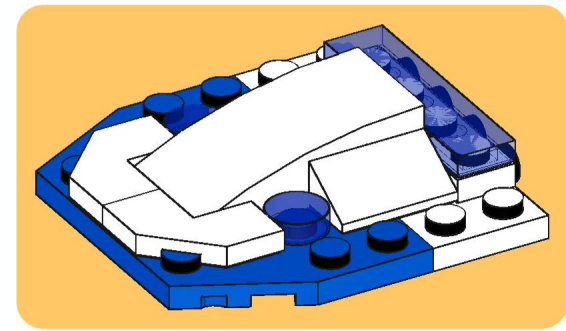
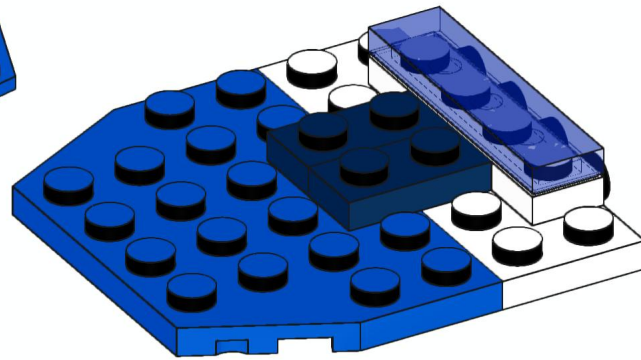
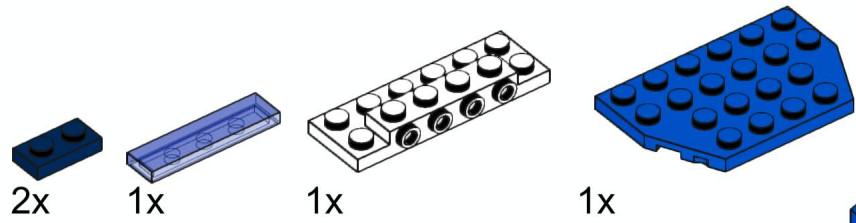

14

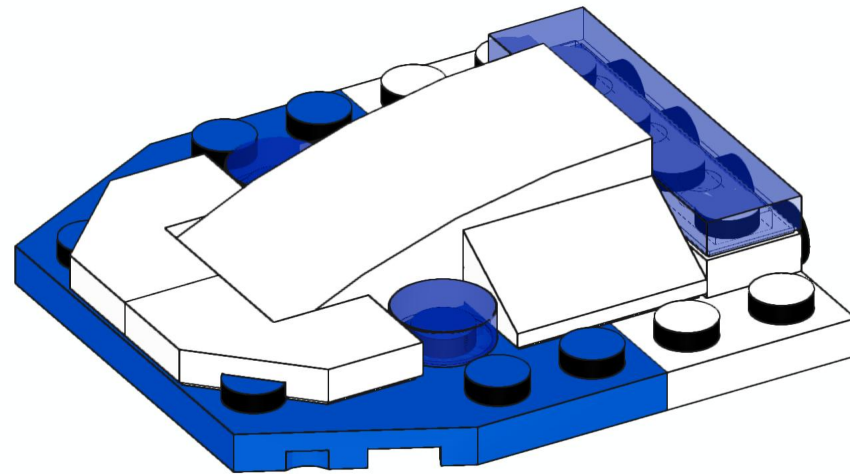
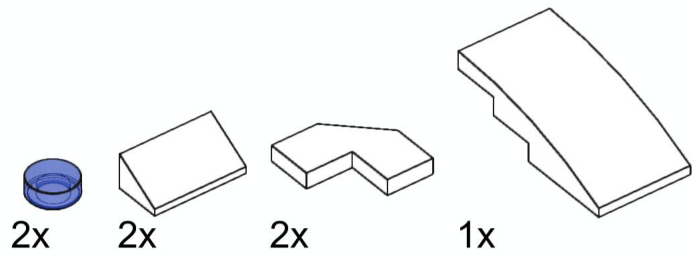

15

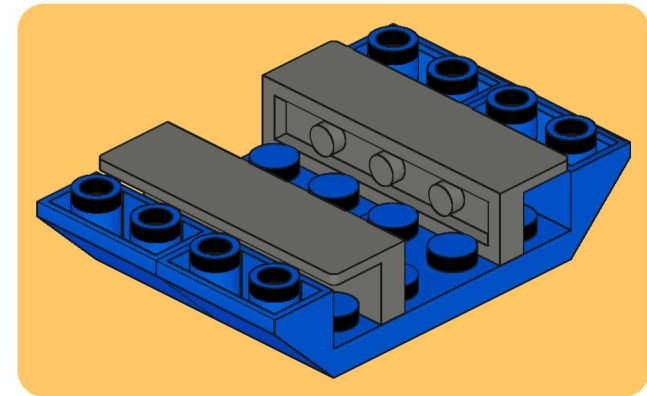
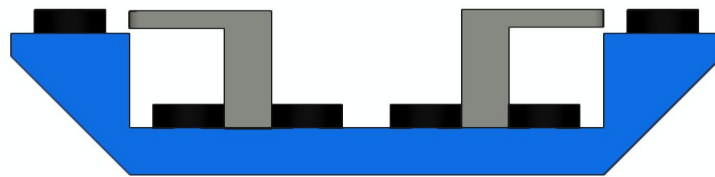
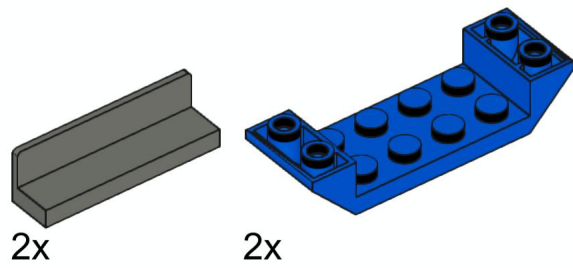



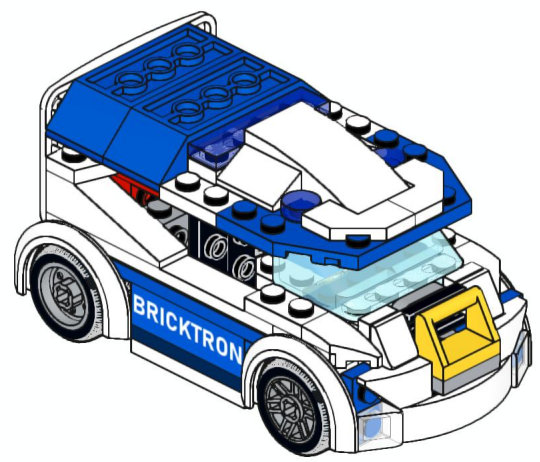
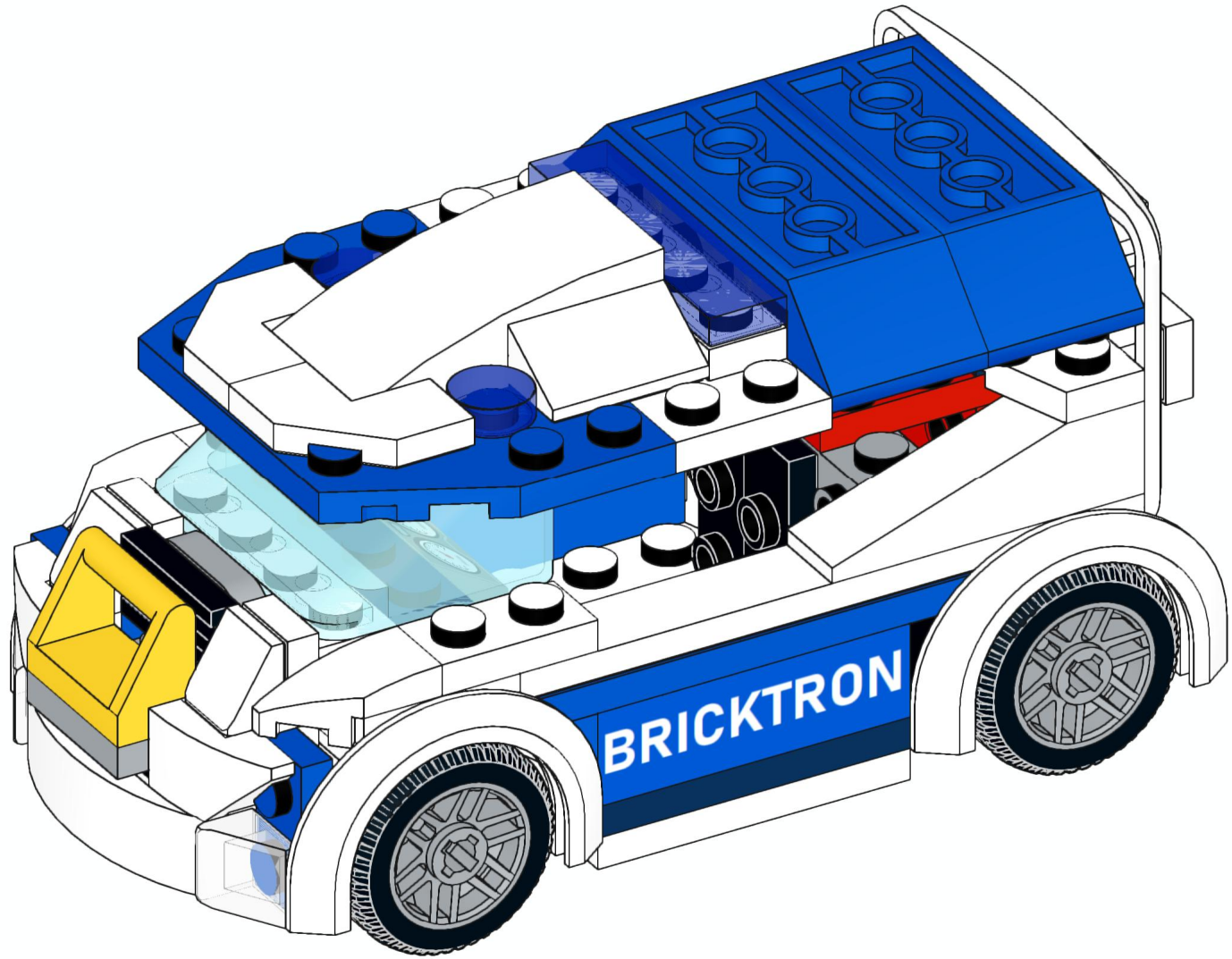

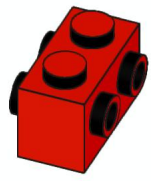

1x  
52107, 5

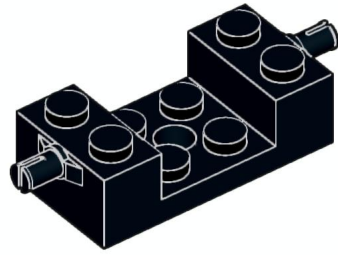

2x  
18892, 11



2x  
34103, 11

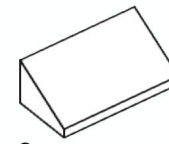
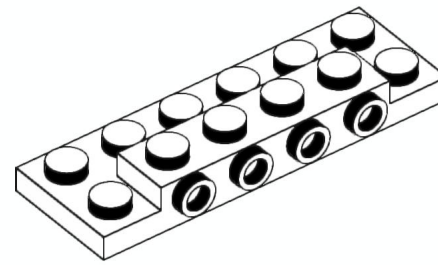

2x  
85984, 1

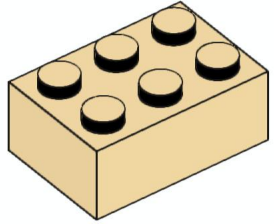

1x  
3002, 2

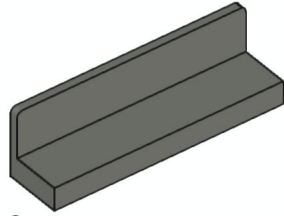

2x  
30413, 85

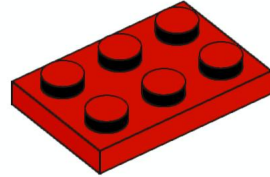

2x  
3021, 5

2x  
87609, 1

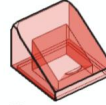

2x  
54200, 17

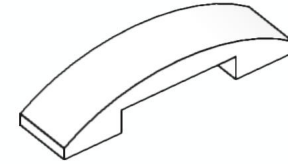

1x  
93273, 1



1x  
47456, 11

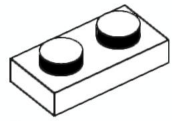

6x  
3023, 1

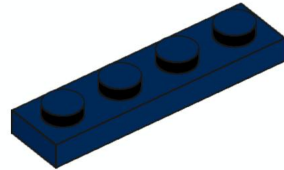

3x  
3710, 63



2x  
54200, 12

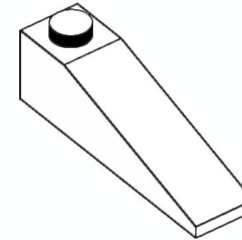

2x  
60477, 1

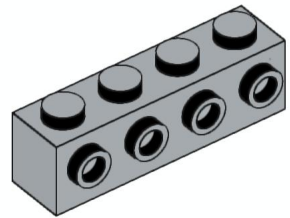

1x  
30414, 86

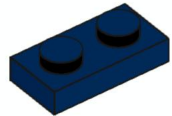

3x  
3023, 63

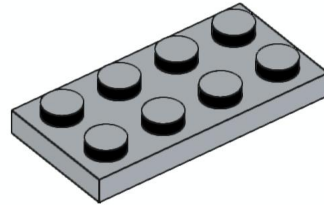

1x  
3020, 86



2x  
54200, 1

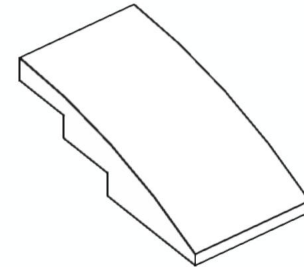

1x  
93606, 1



1x  
35480, 86

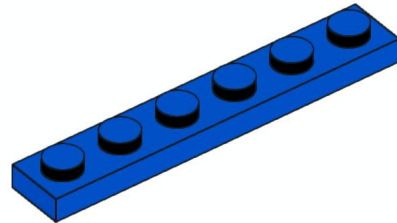

2x  
3666, 7

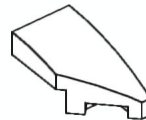

2x  
29119, 1

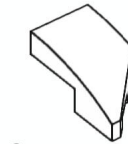

2x  
29120, 1

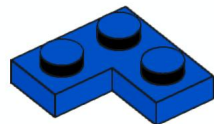

2x  
2420, 7

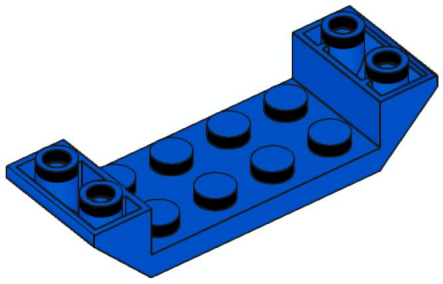

2x  
22889, 7

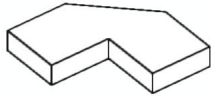

2x  
27263, 1

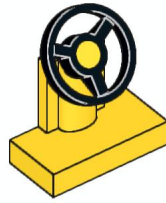

1x  
3829c01, 3



1x  
85984pb100, 85

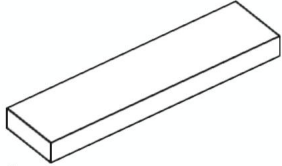

1x  
2431, 1

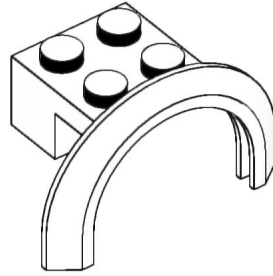

4x  
50745, 1



2x  
98138, 14

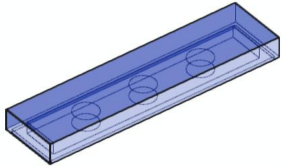

1x  
2431, 14

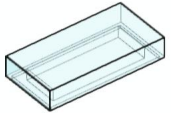

1x  
3069b, 15

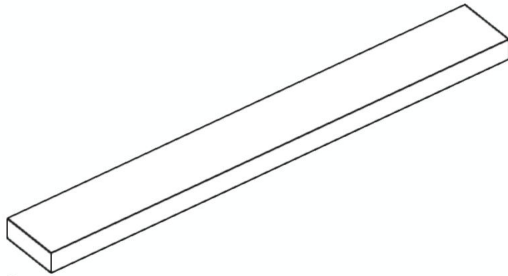

2x  
4162, 1



1x  
2412b, 11

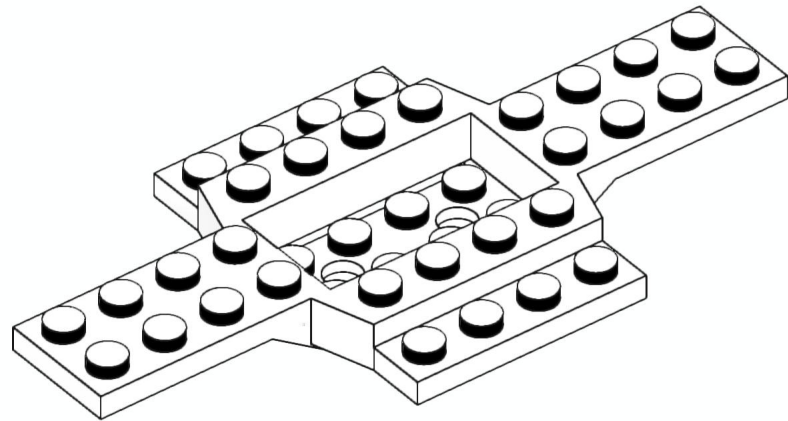

1x  
28324, 1

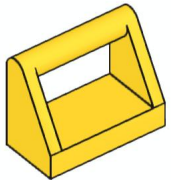

1x  
2432, 3



4x  
11209, 11

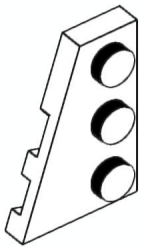

1x  
43723, 1

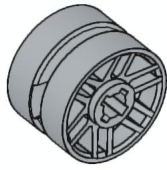

4x  
11208, 86

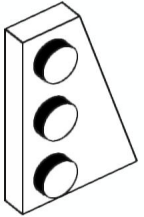

1x  
43722, 1

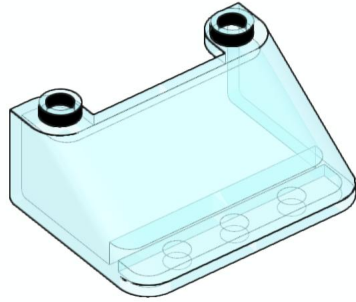

1x  
57783, 15

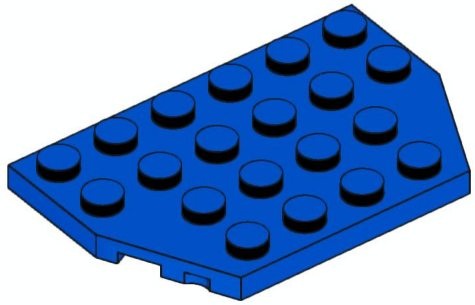

1x  
32059, 7



2x



1x  
98281, 1