

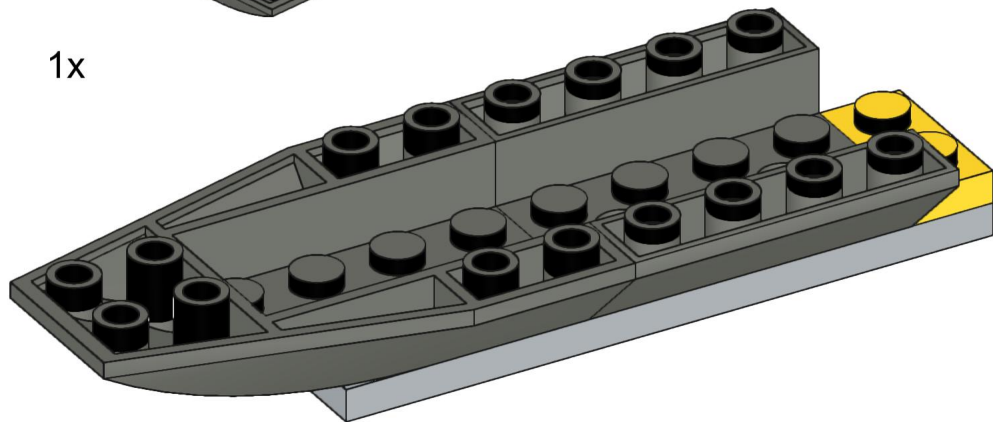

1

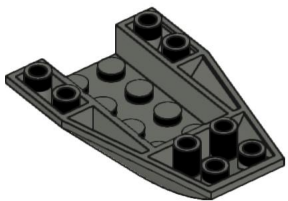

2

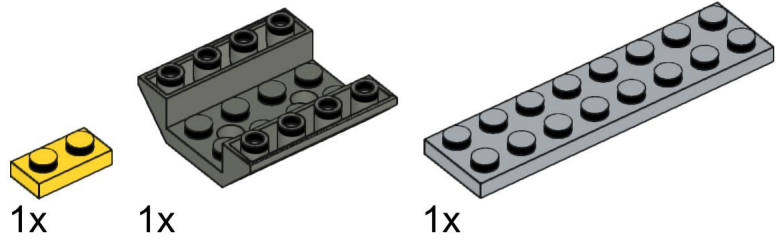
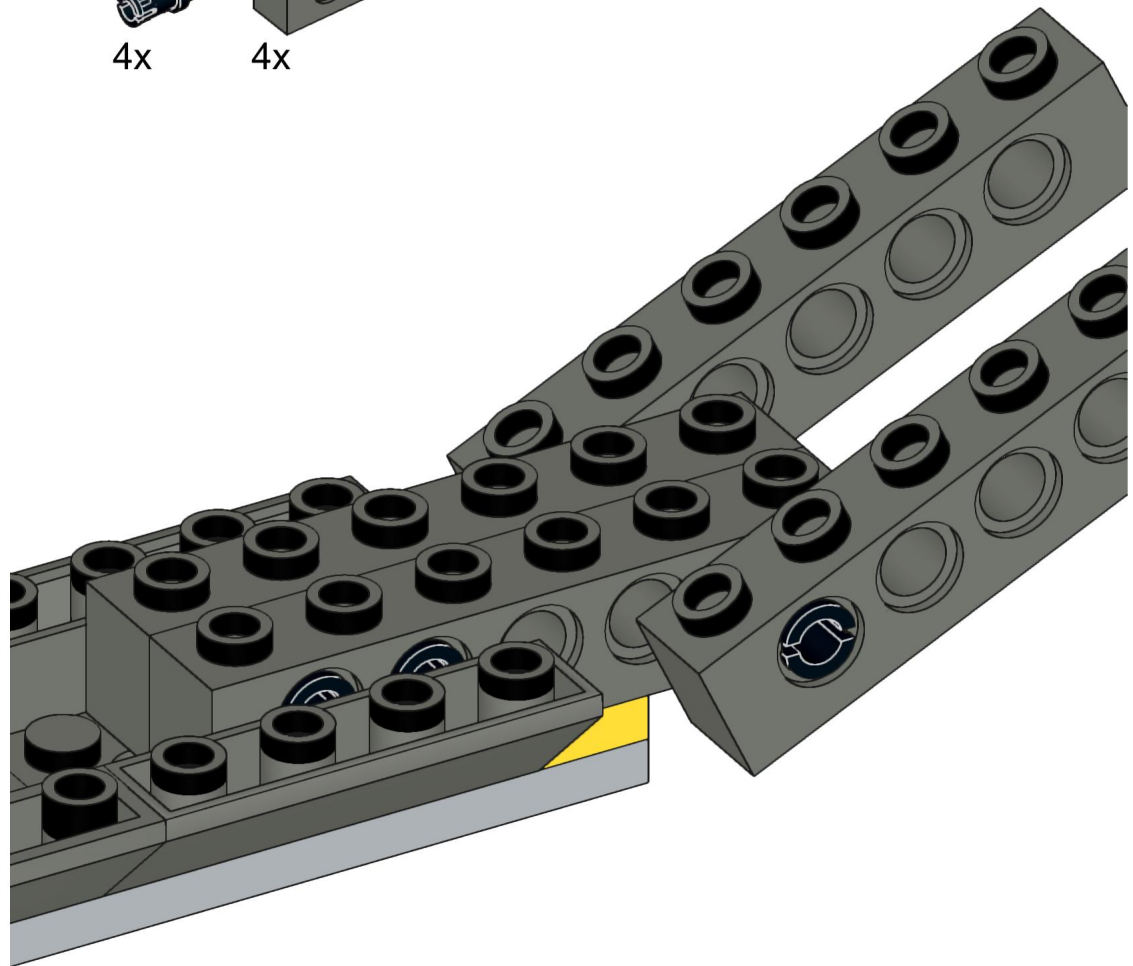
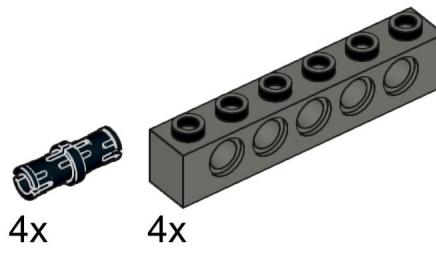

3

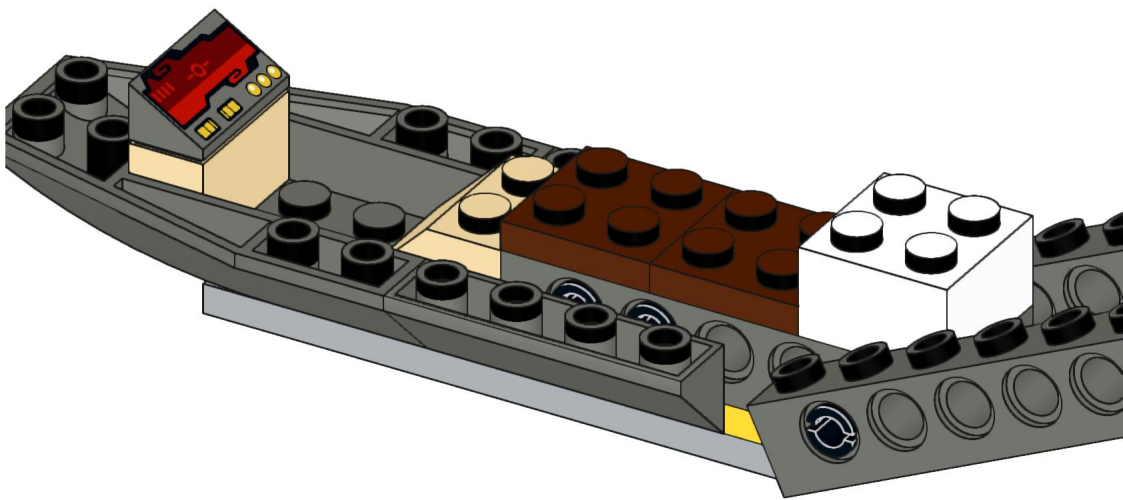
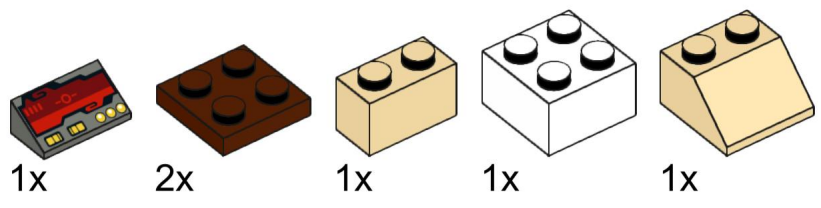

4

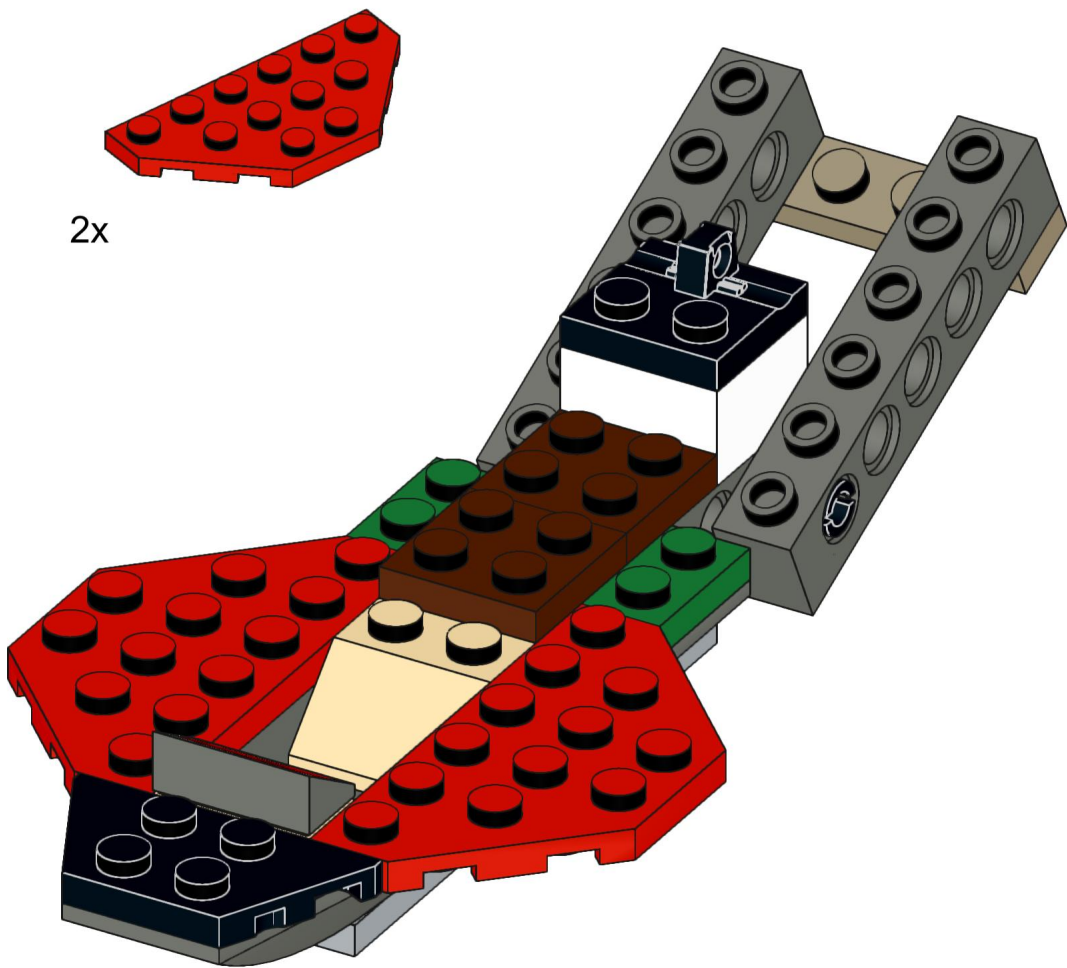
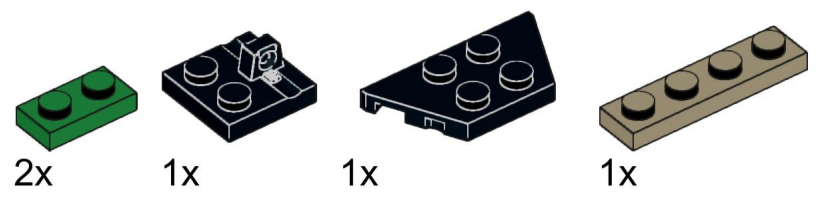

7

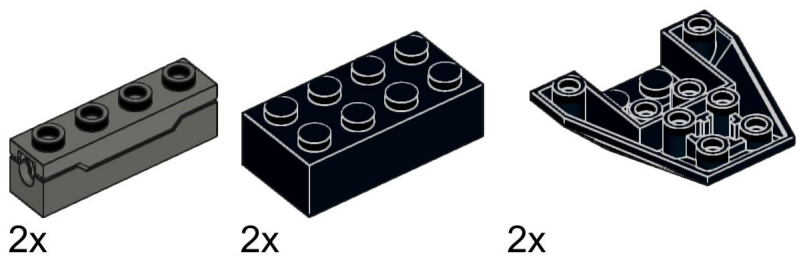

8

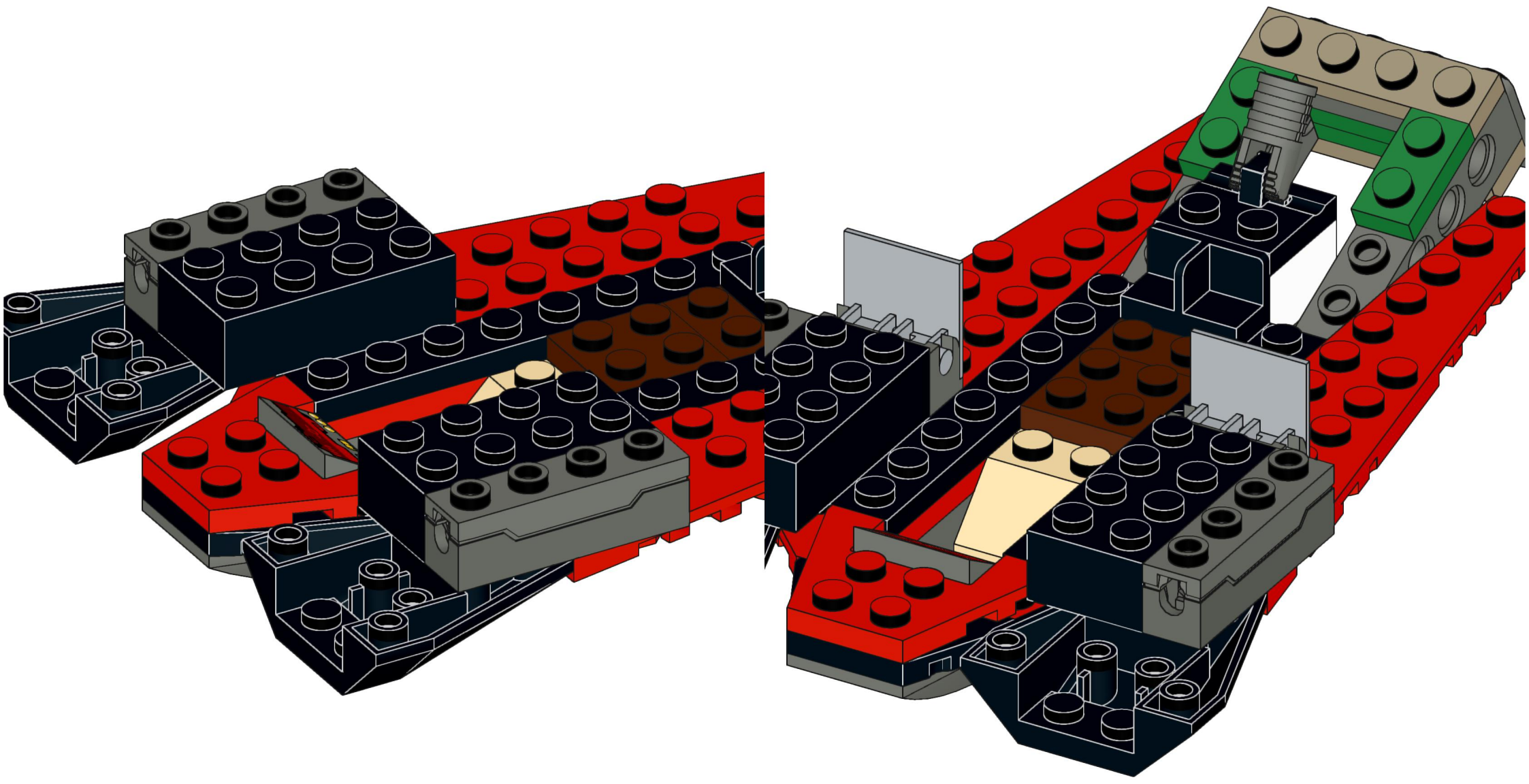
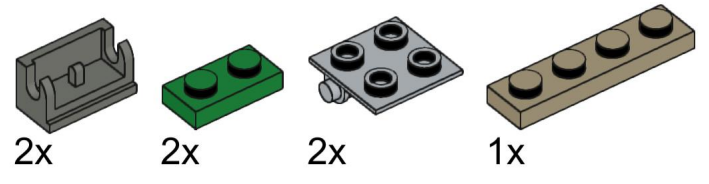

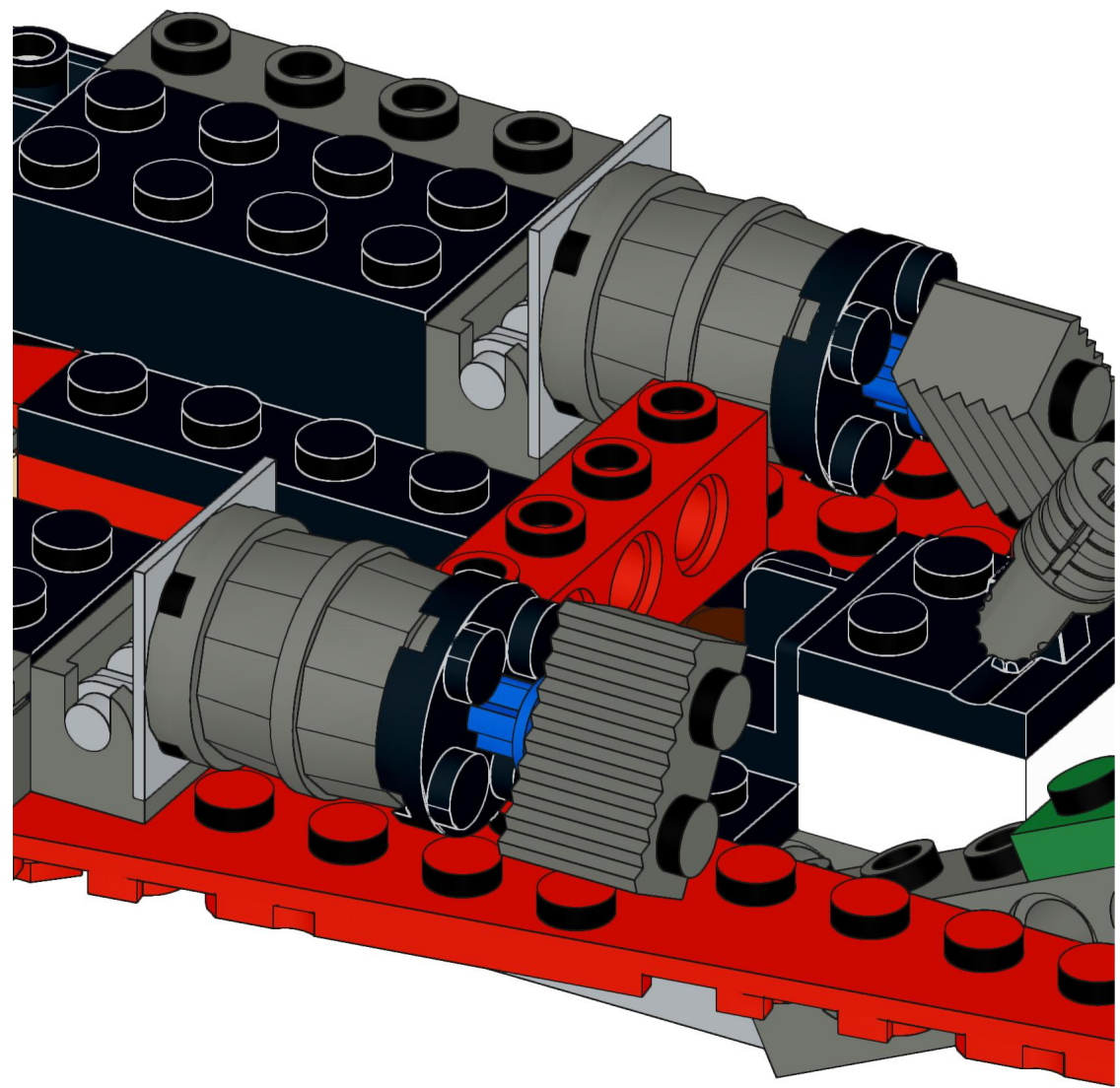
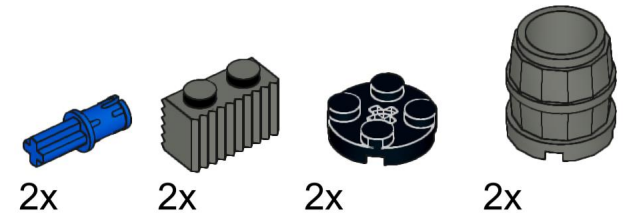
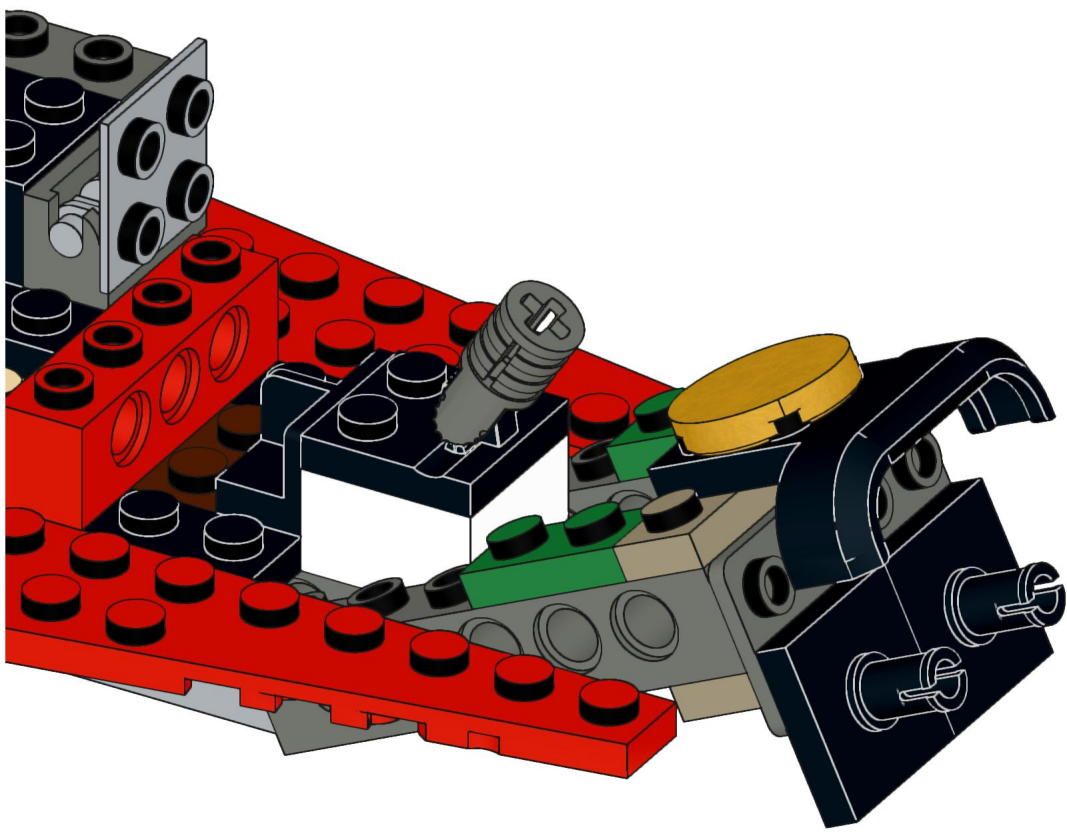
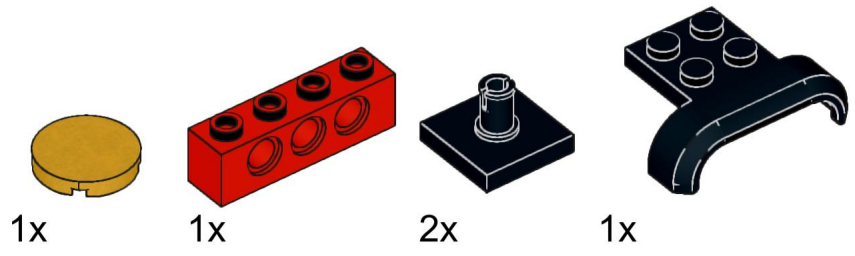

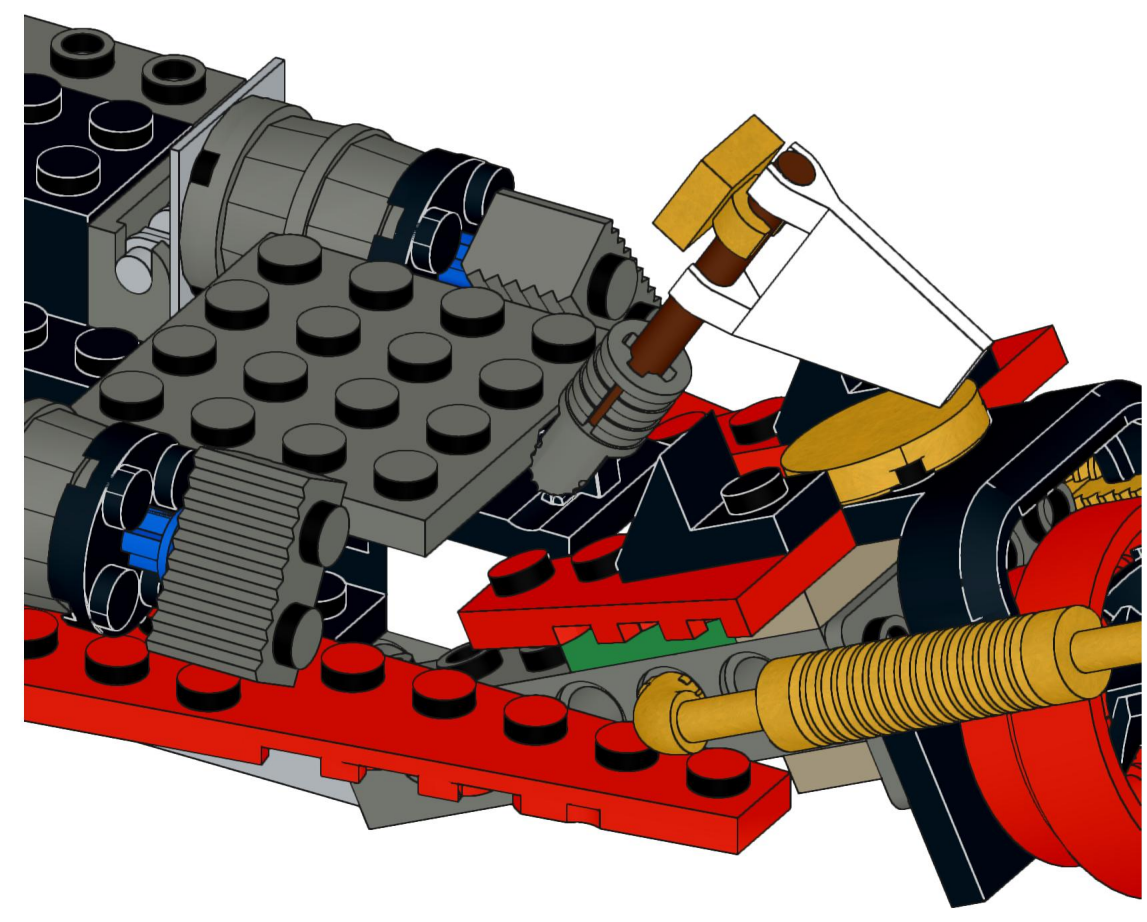
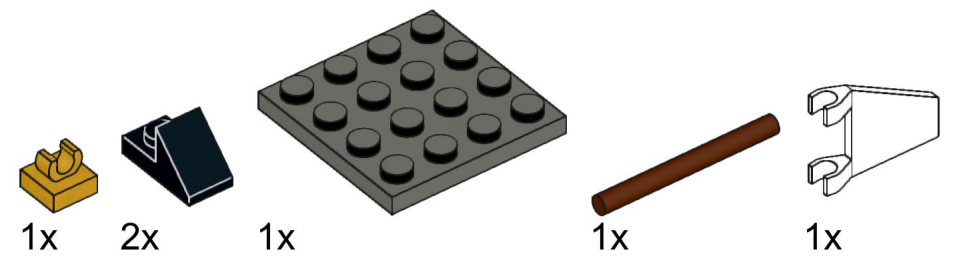
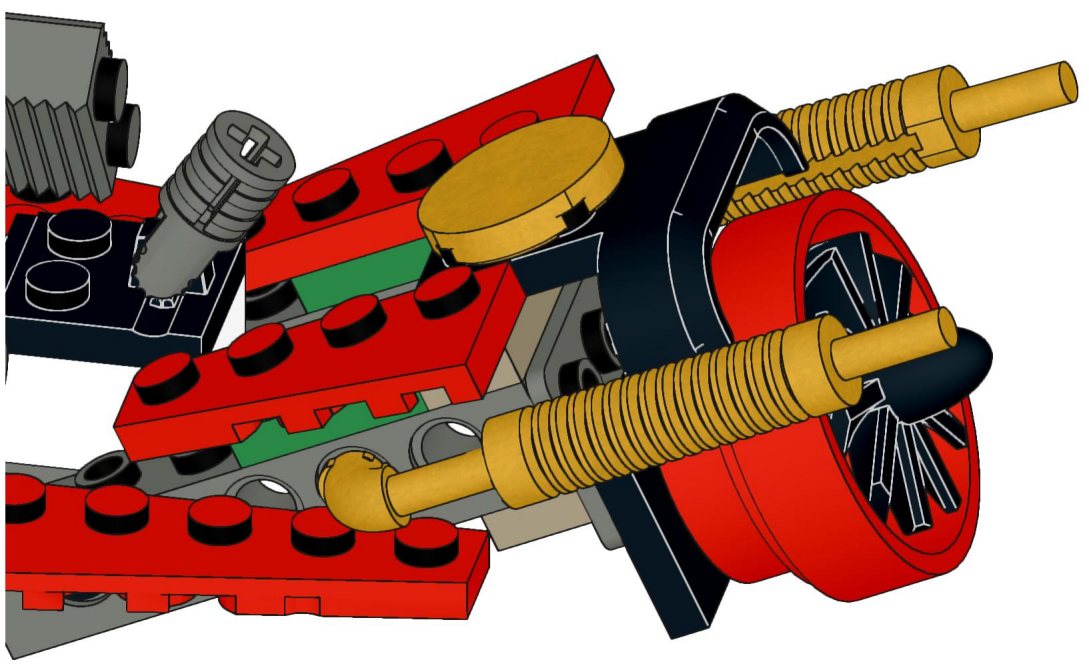
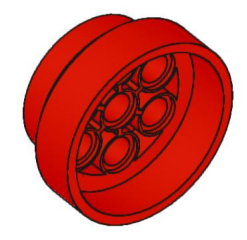

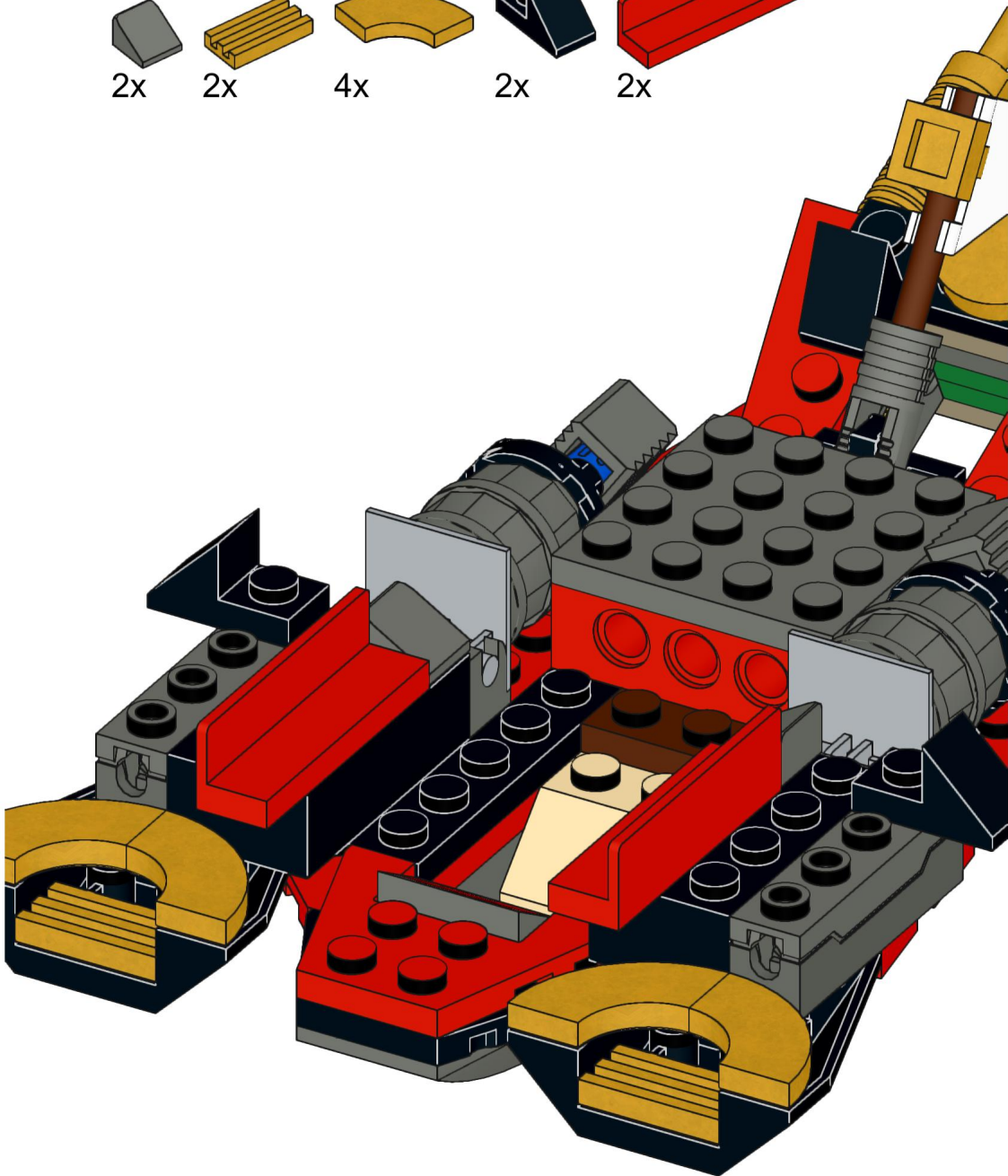

- 2x
- 2x
- 4x
- 2x
- 2x



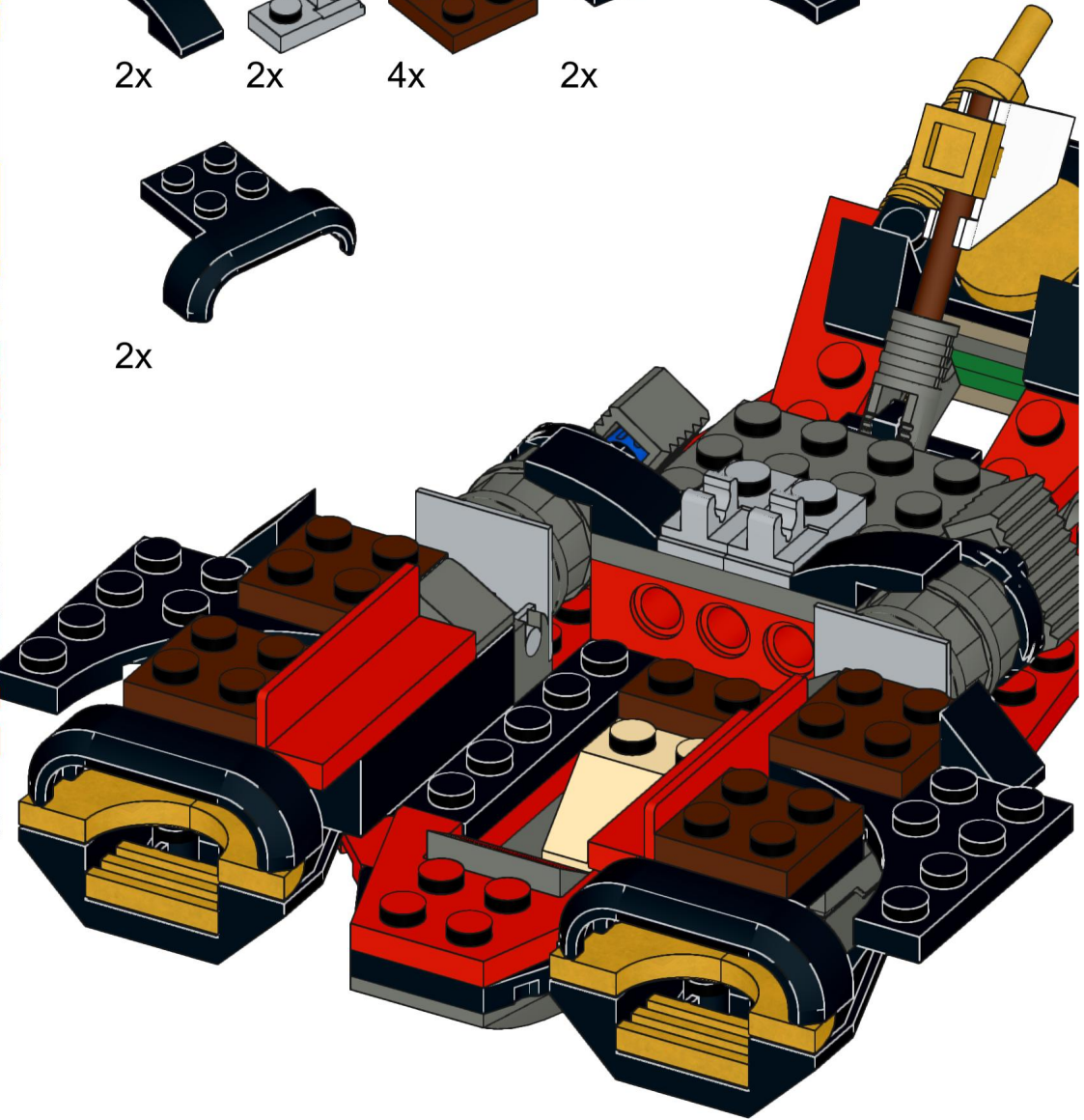



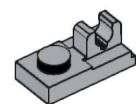
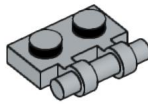
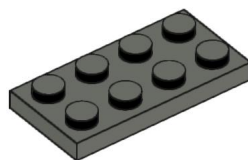
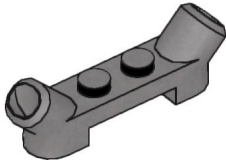

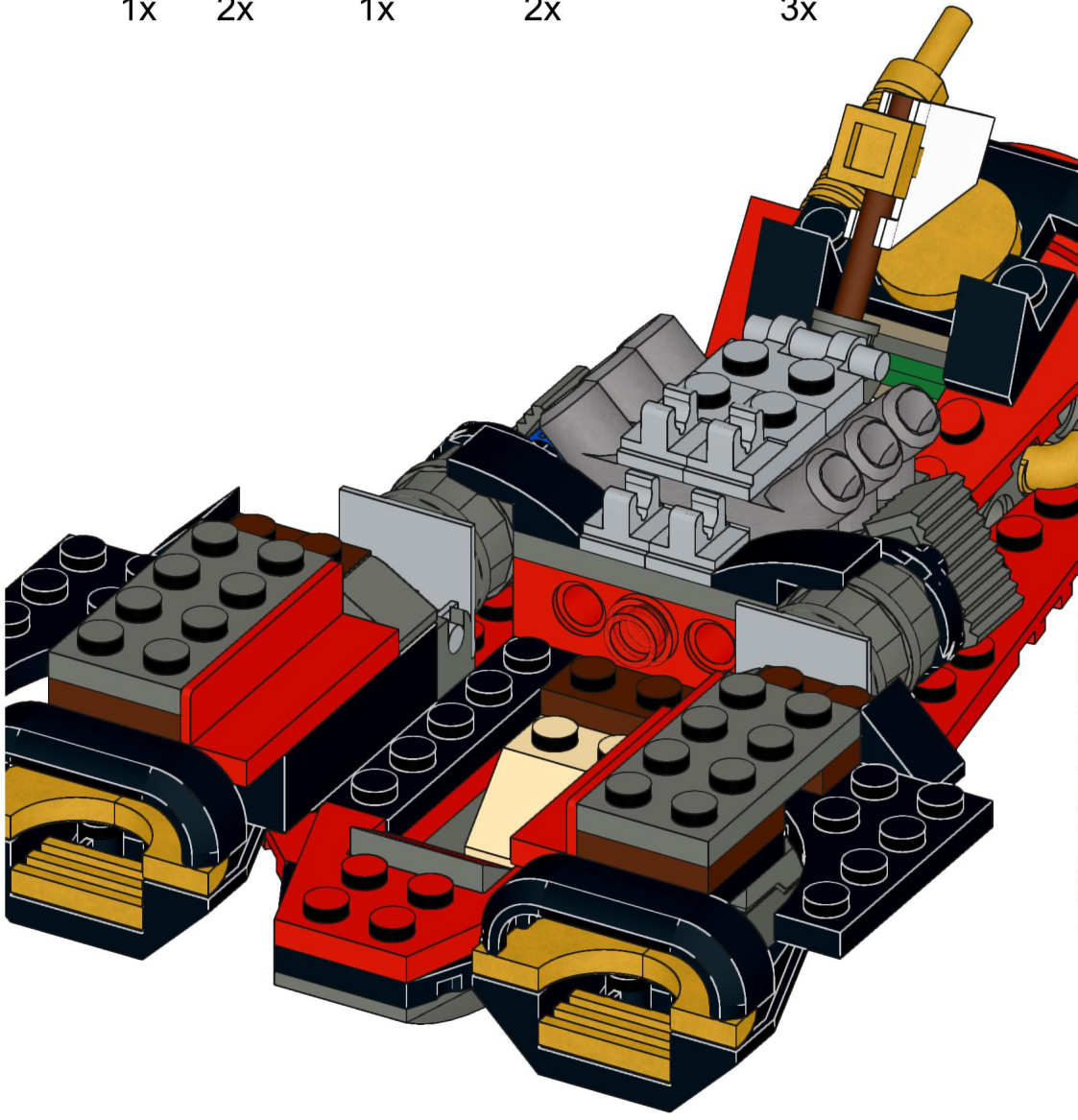
- 2x
- 2x
- 4x
- 2x







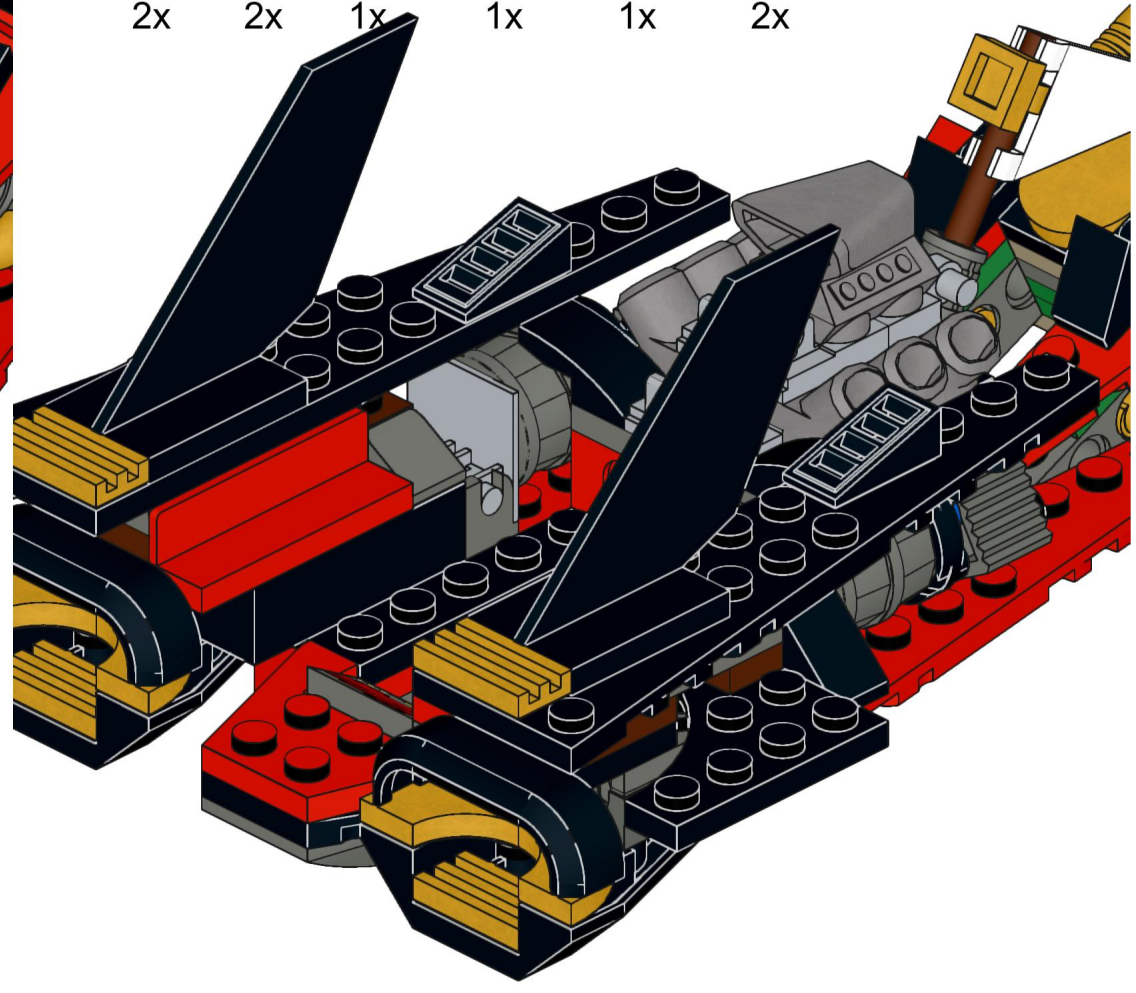

- 
1x
- 
2x
- 
1x
- 
2x
- 
3x



- 
2x
- 
2x
- 
1x
- 
1x
- 
1x
- 
2x

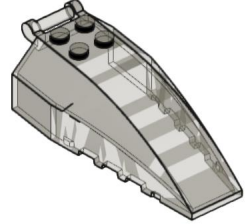

-  2x
-  2x
-  2x
-  1x
-  1x
-  2x
-  1x

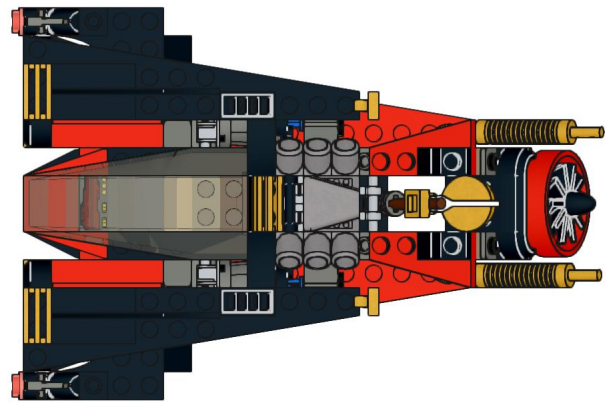
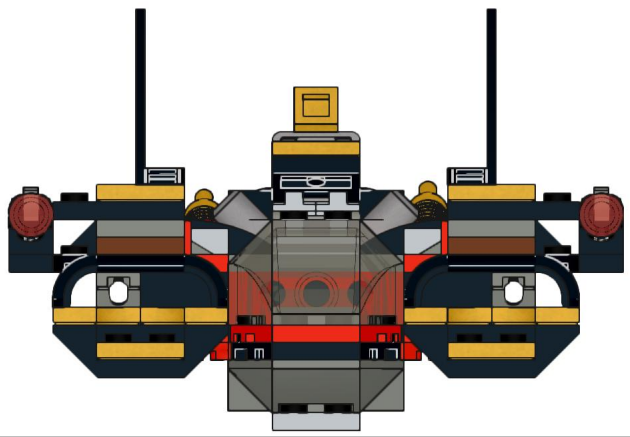
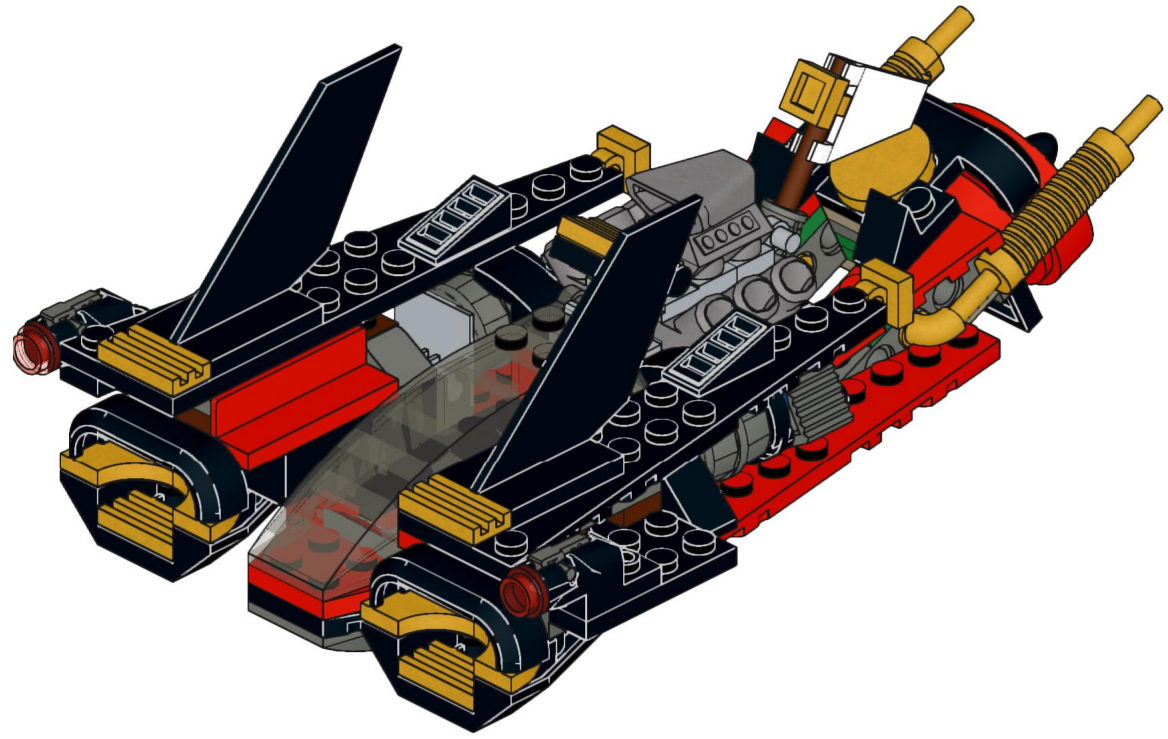
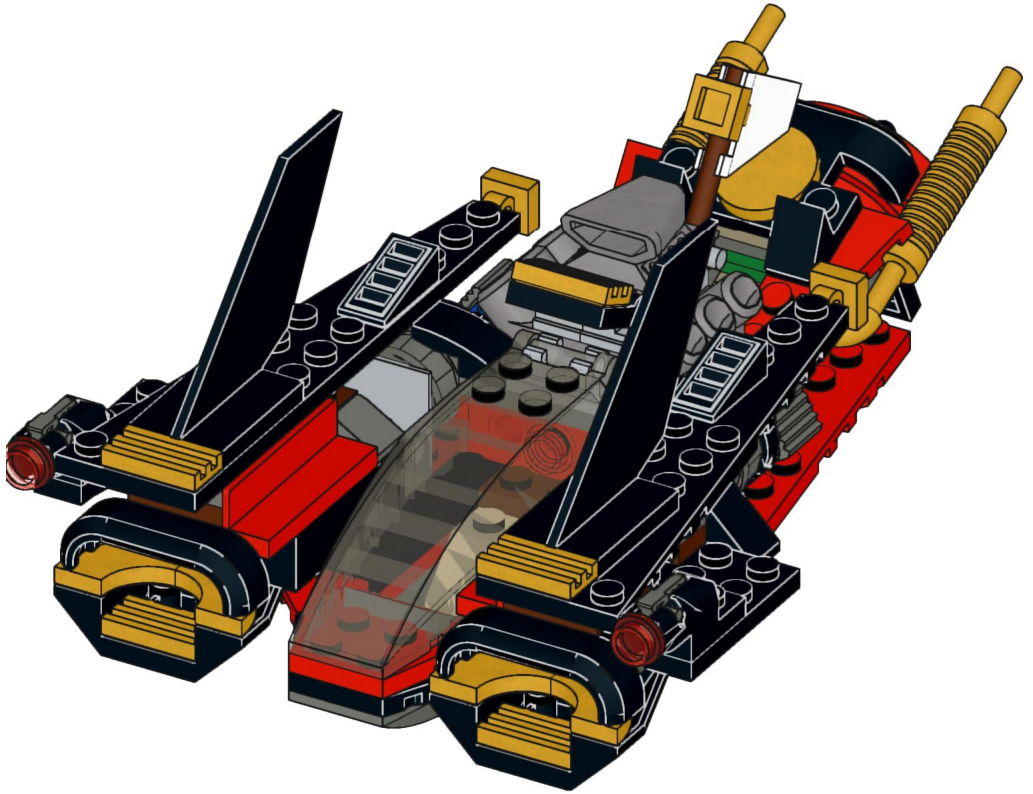





2x
11477, 11



2x
15392, 85



2x
2489, 85

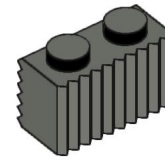

2x
2877, 85

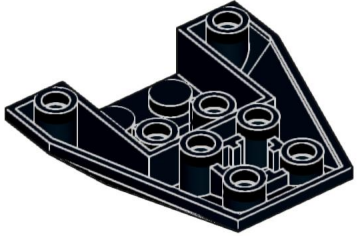

2x
13349, 11



2x
15403, 11

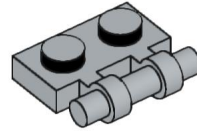

1x
2540, 86

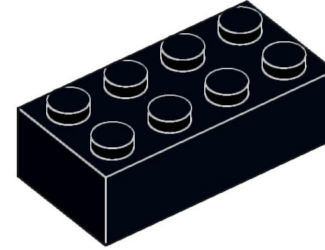

2x
3001, 11

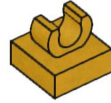

3x
15712, 115



4x
2780, 11

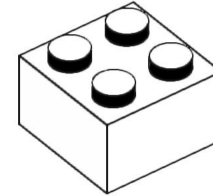

1x
3003, 1

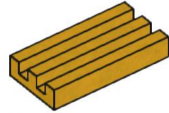
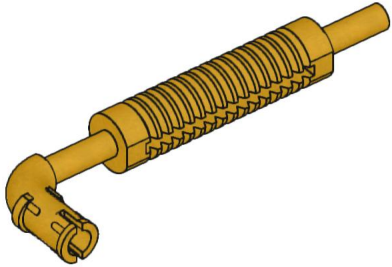

5x
2412b, 115



4x
27925, 115

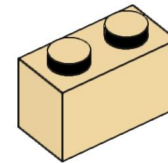

1x
3004, 2

2x
14682, 115

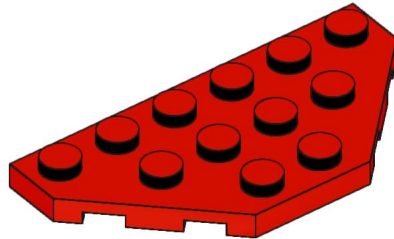

2x
2419, 5



3x
28326, 11

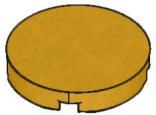

1x
14769, 115

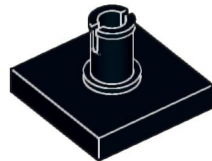

2x
2460, 11

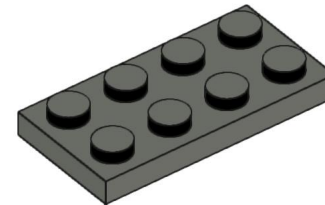

2x
3020, 85

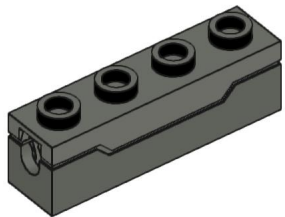

2x
15301c01, 85

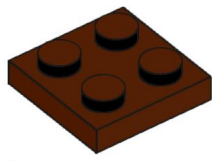

6x
3022, 88

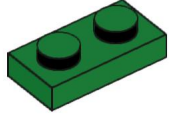

6x
3023, 6

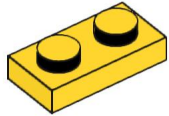

1x
3023, 3

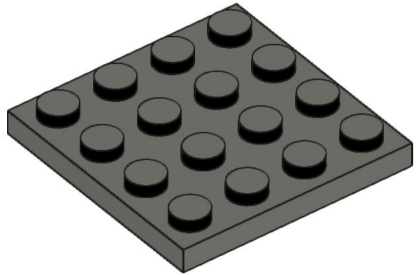

1x
3031, 85

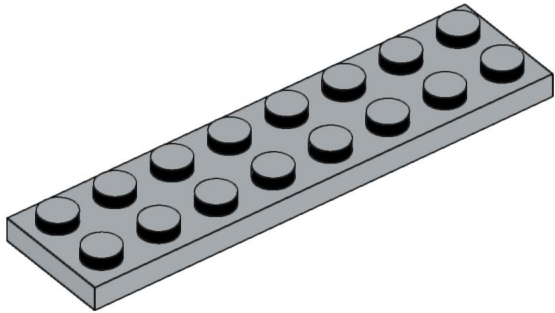

1x
3034, 86



1x
30374, 88

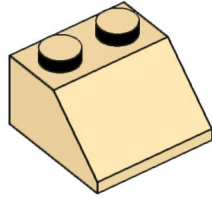

1x
3039, 2

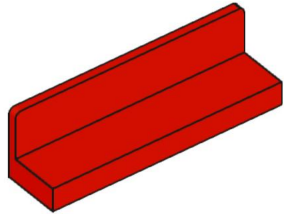

2x
30413, 5



1x
30553, 85



2x
3460, 11



2x
35044, 11

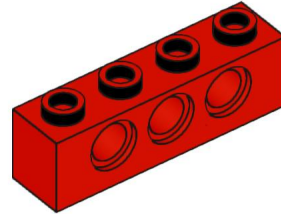

1x
3701, 5

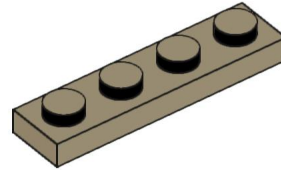

2x
3710, 69

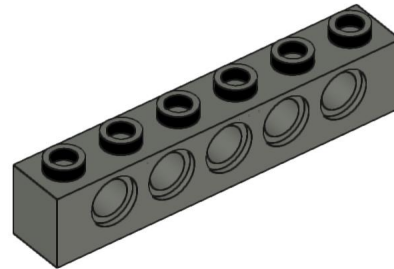

4x
3894, 85

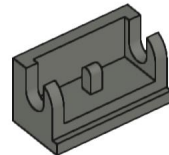

2x
3937, 85



2x
4032, 11



3x
4073, 17

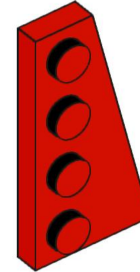

1x
41769, 5

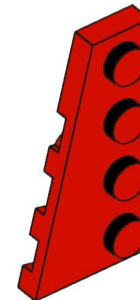

1x
41770, 5



2x
43093, 7

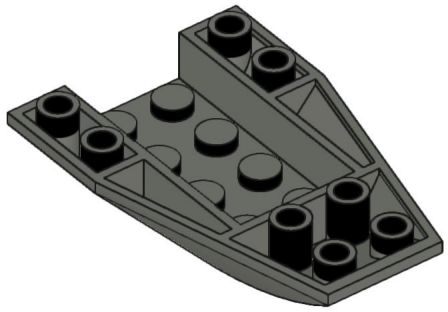

1x
43713, 85

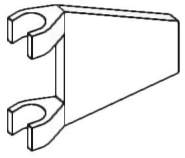

1x
44676, 1

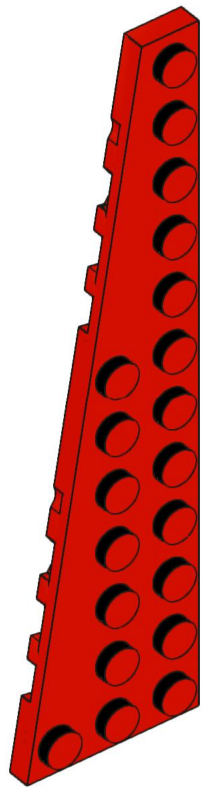

1x
47397, 5

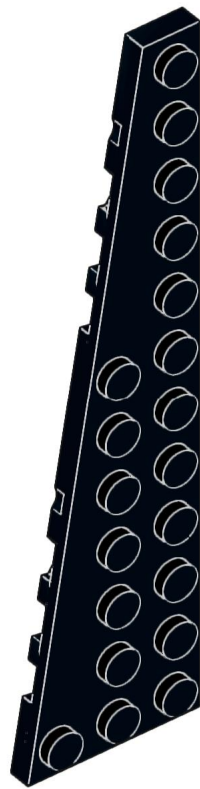

1x
47397, 11

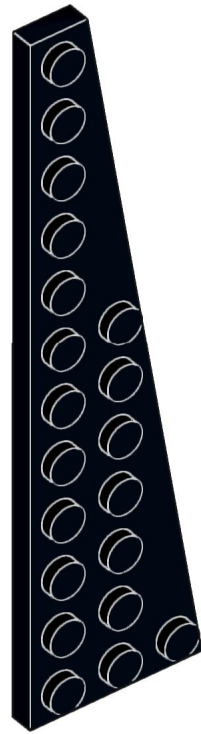

1x
47398, 11

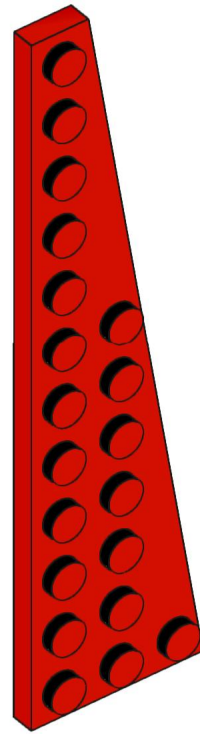

1x
47398, 5

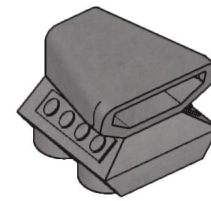

1x
50943, 95

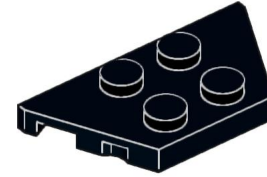

1x
51739, 11



2x
54200, 85

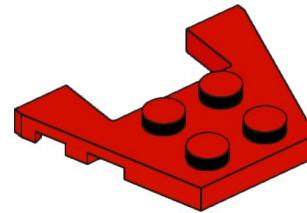

1x
48183, 5

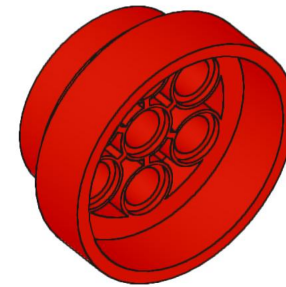

1x
60208, 5

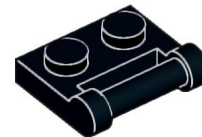

1x
48336, 11

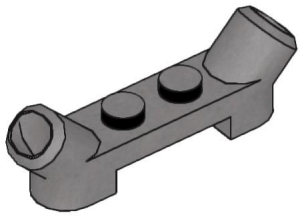

3x
61072, 95

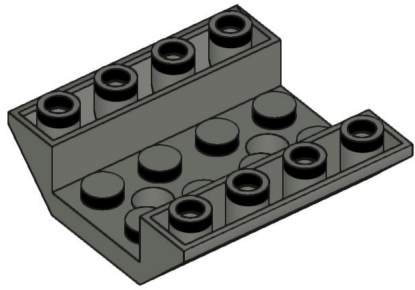

1x
72454, 85

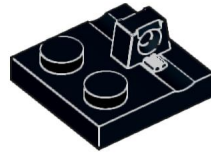

1x
92582, 11

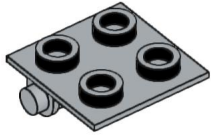

2x
6134, 86



1x
85984pb077, 85



4x
92946, 11



2x
61409, 11

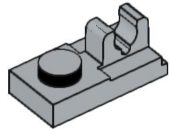

4x
92280, 86

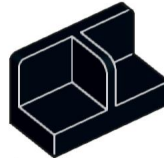

1x
93095, 11

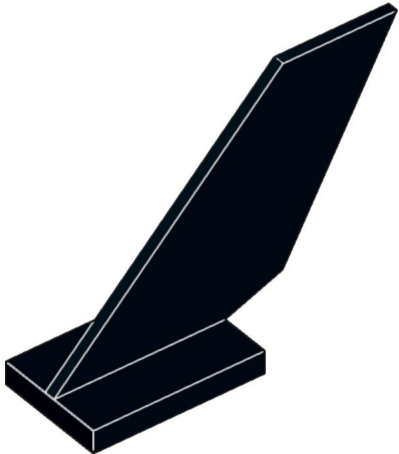

2x
6239, 11

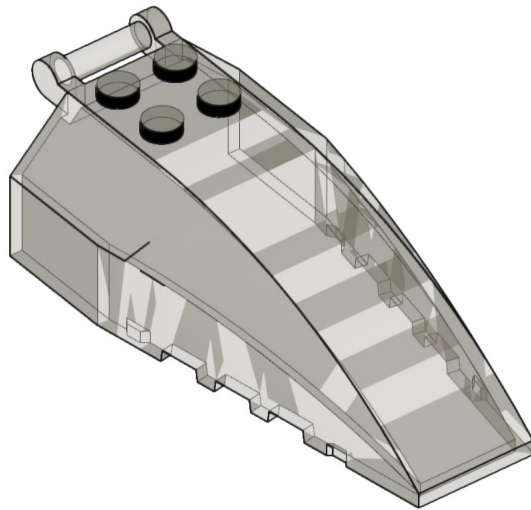

1x
92579, 13

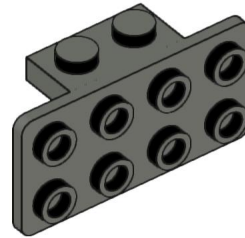

1x
93274, 85



1x
x577, 11