

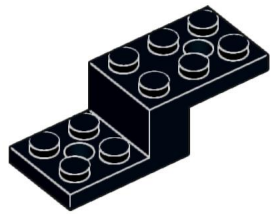

1

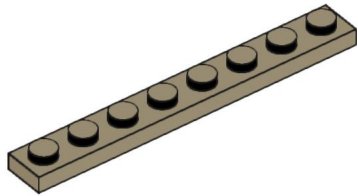

2x



1x

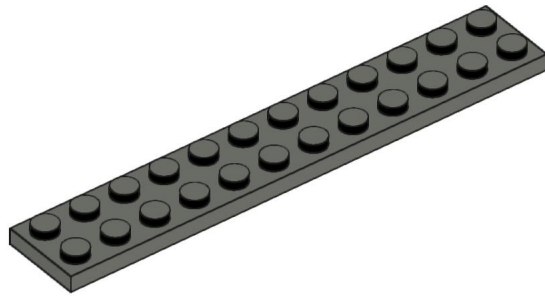

1x

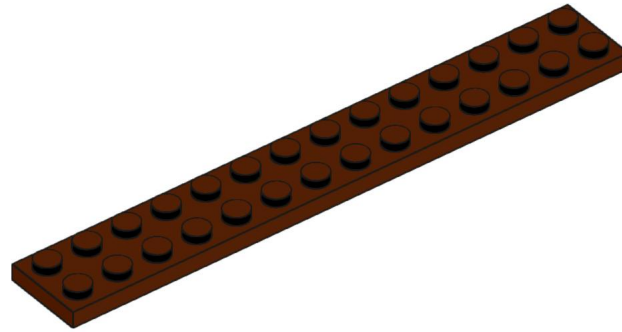

2x



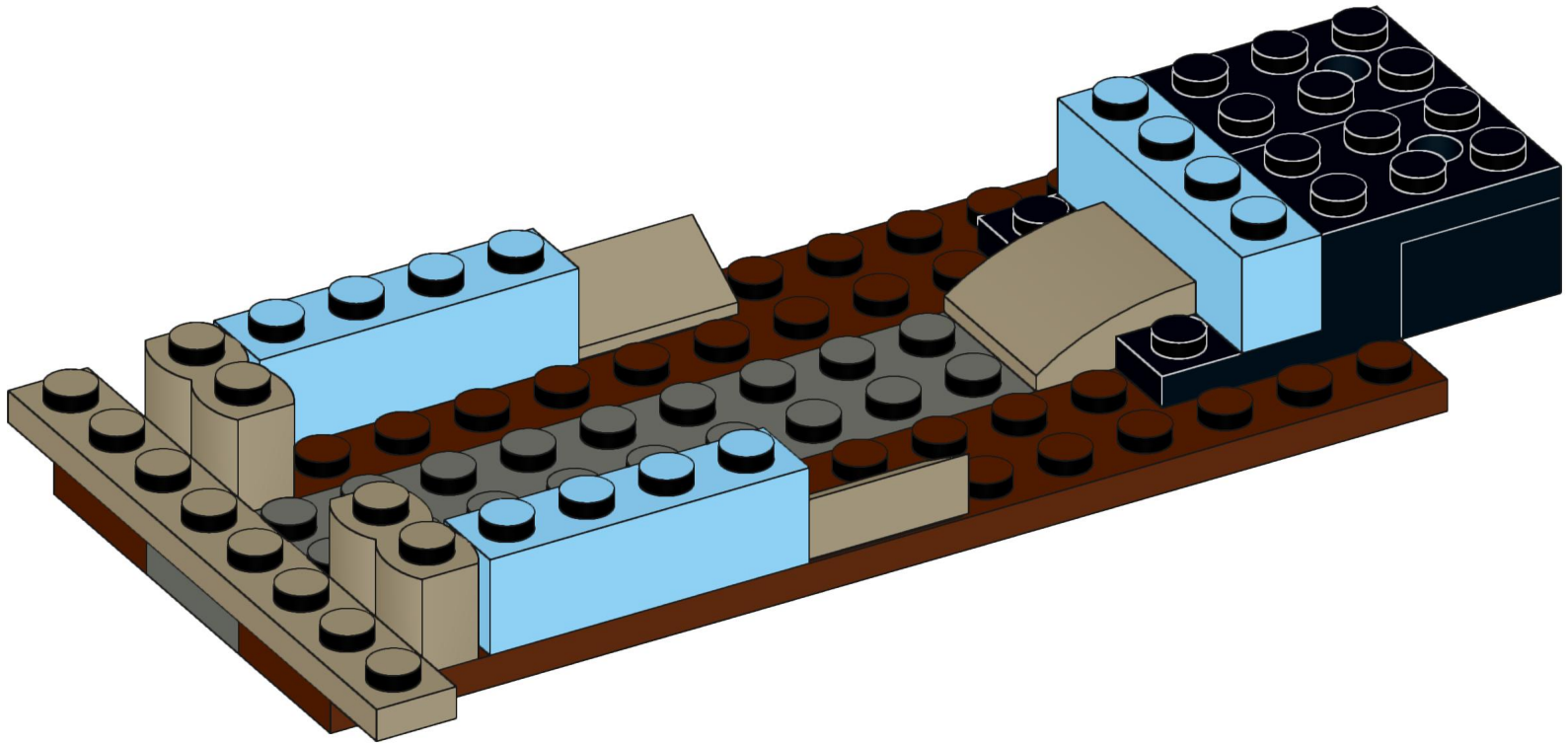
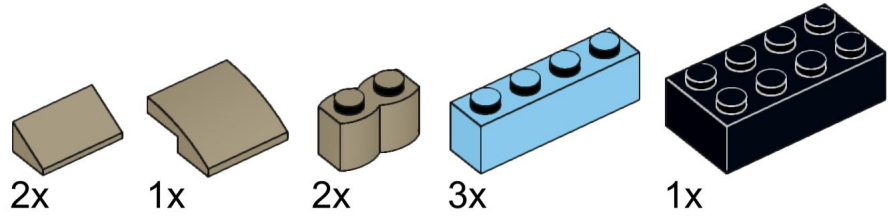



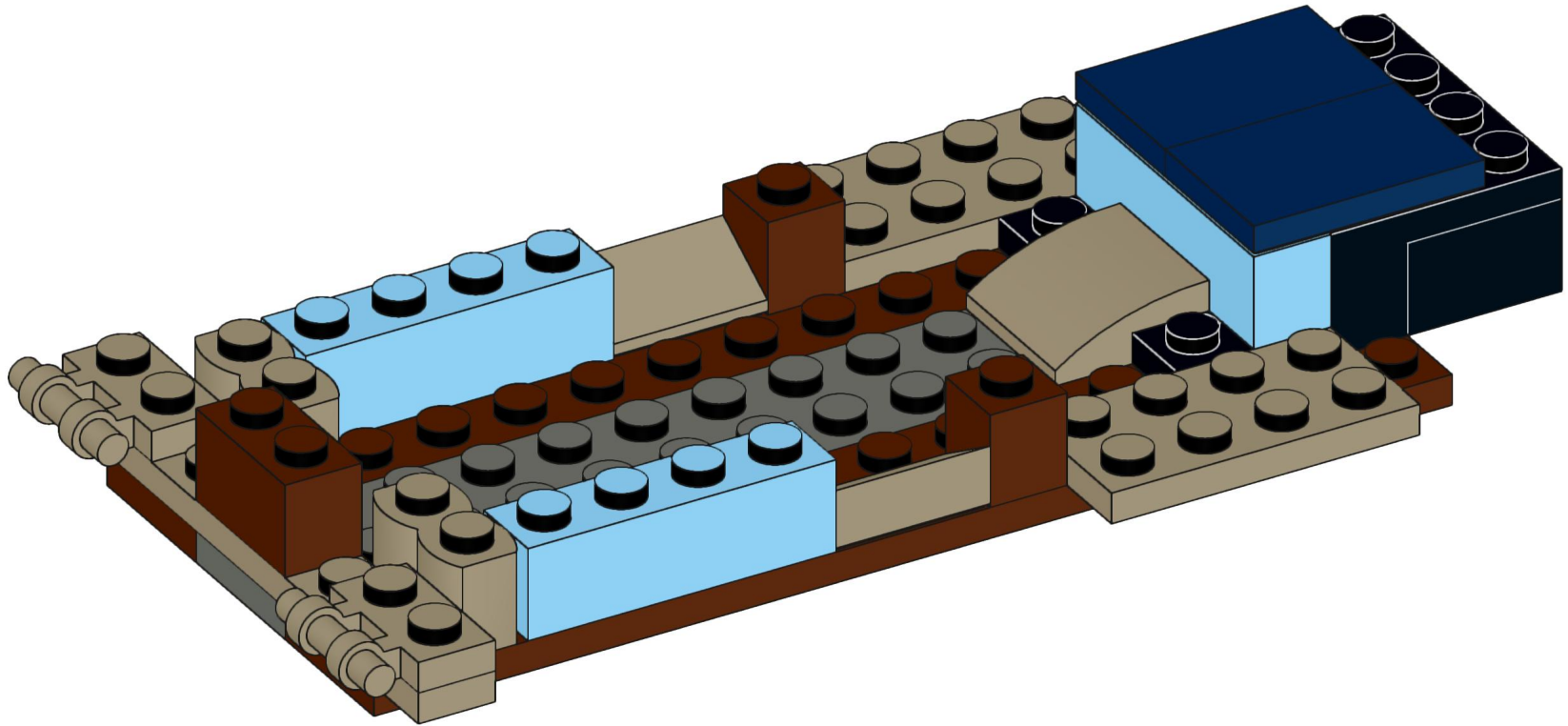
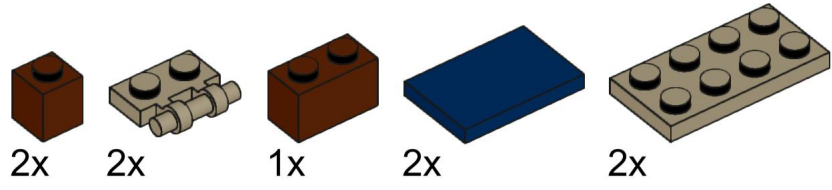

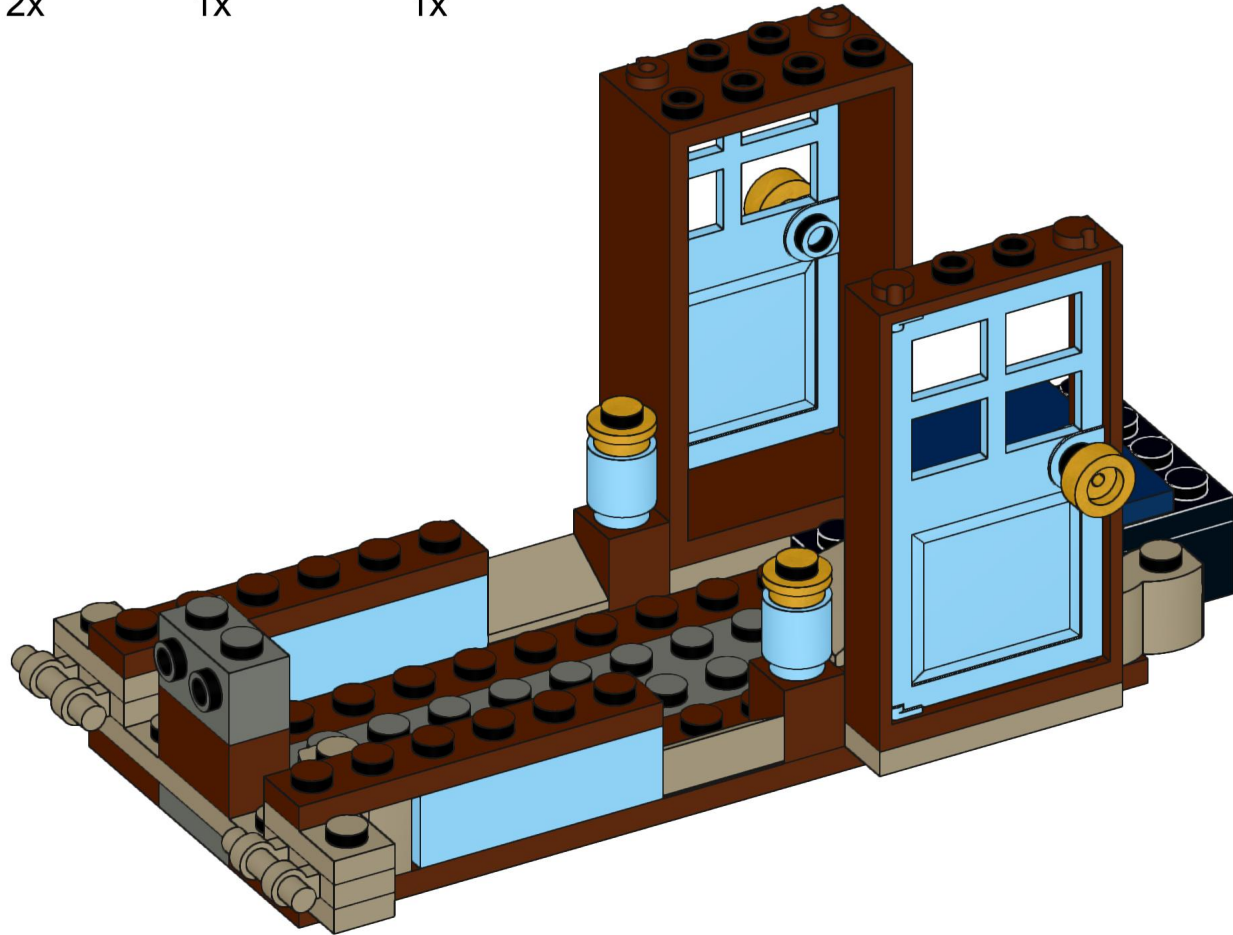
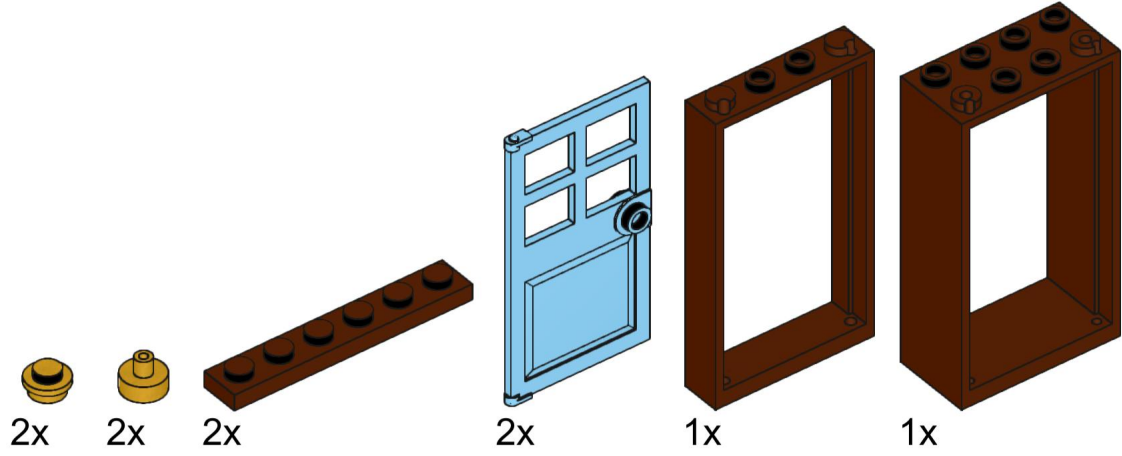

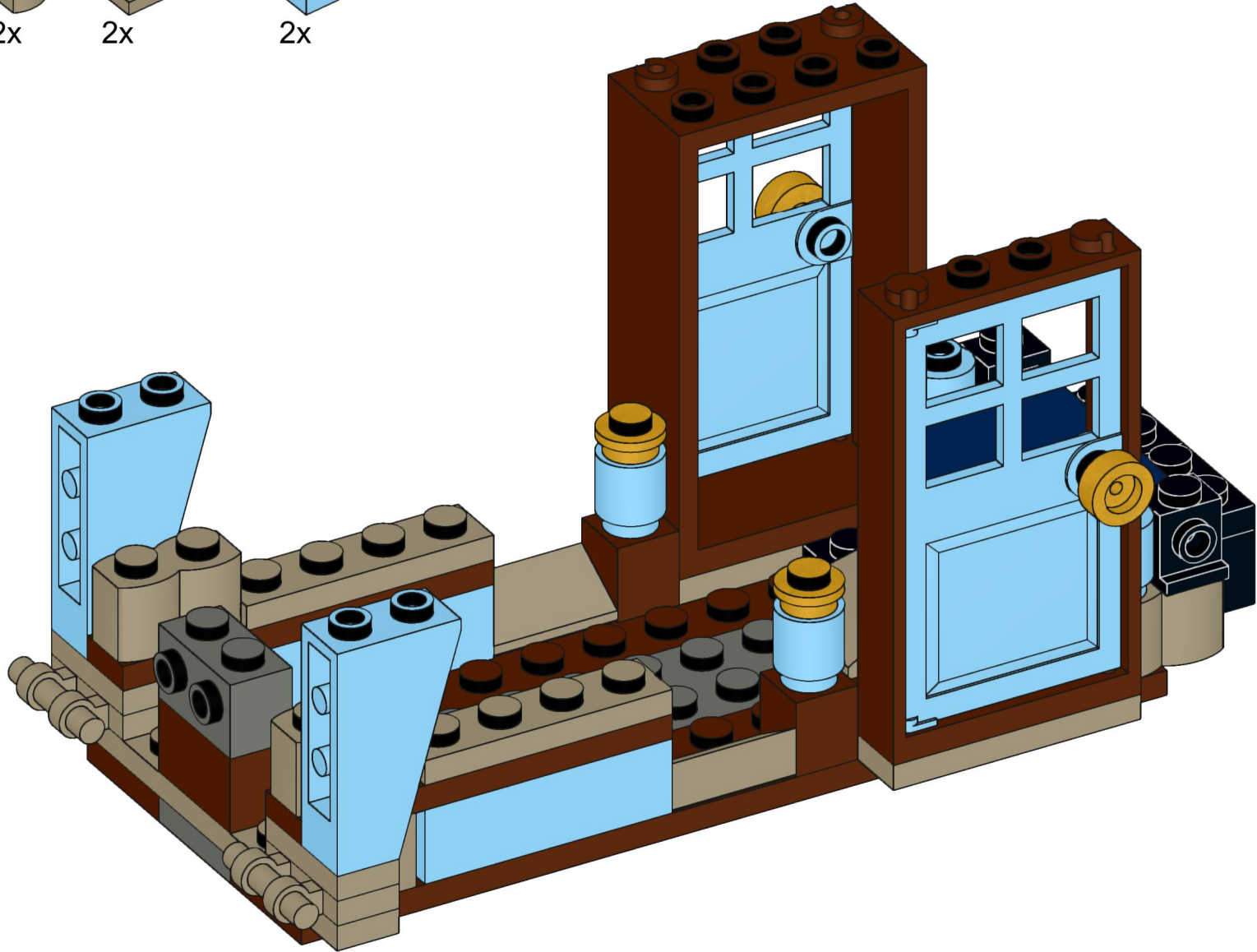
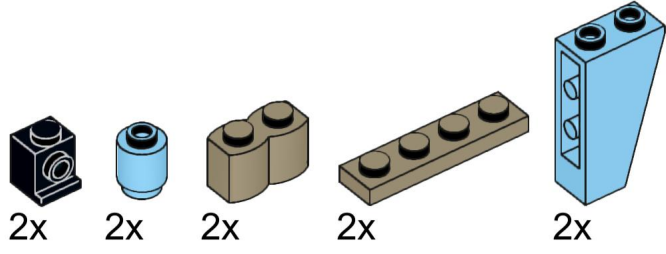
3







- 4x 
- 2x 
- 4x 
- 2x 
- 1x 

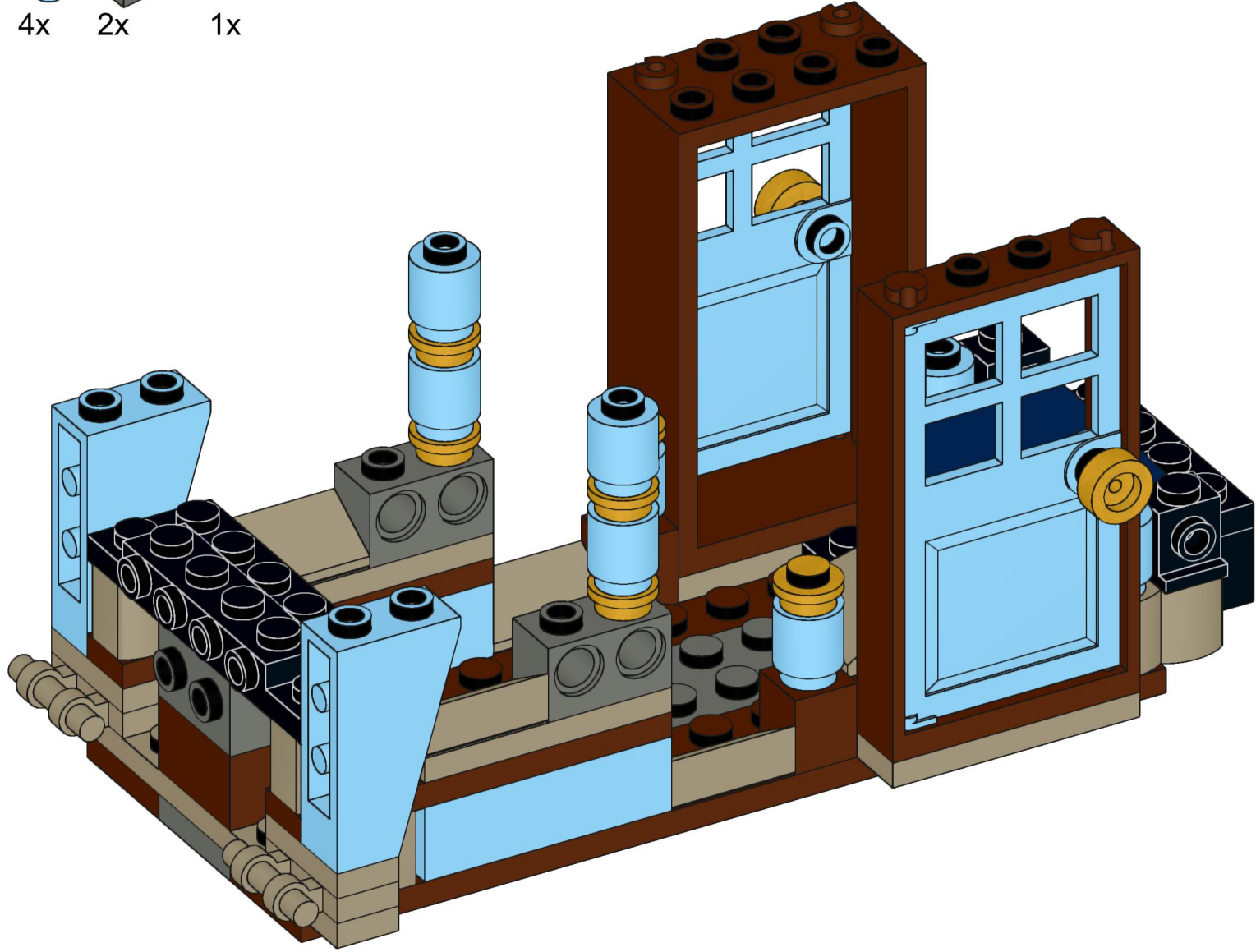

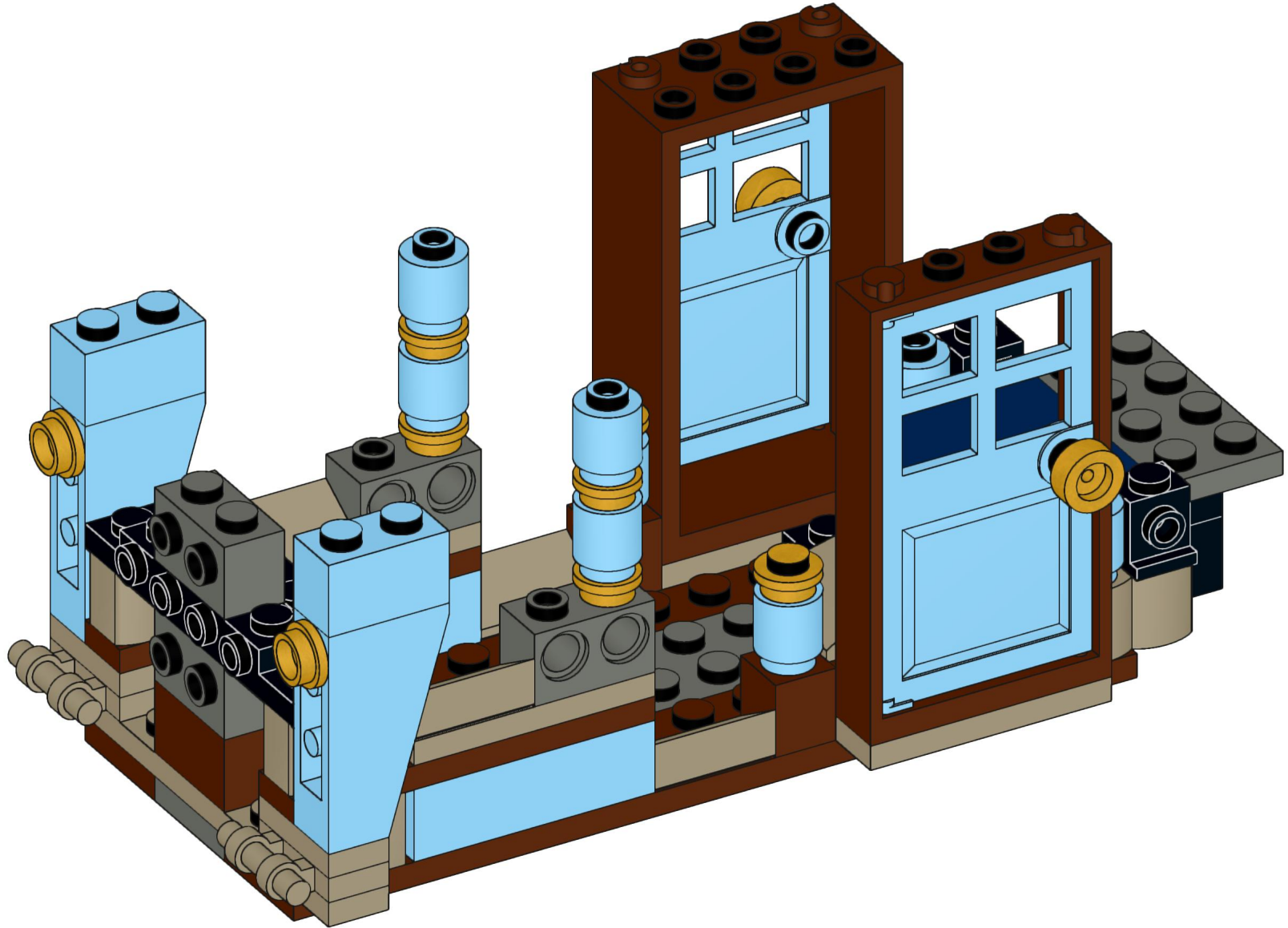
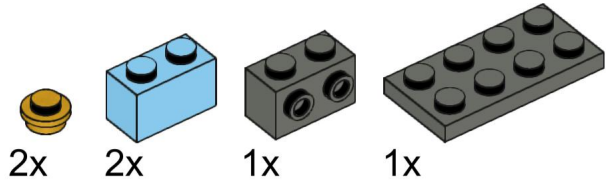

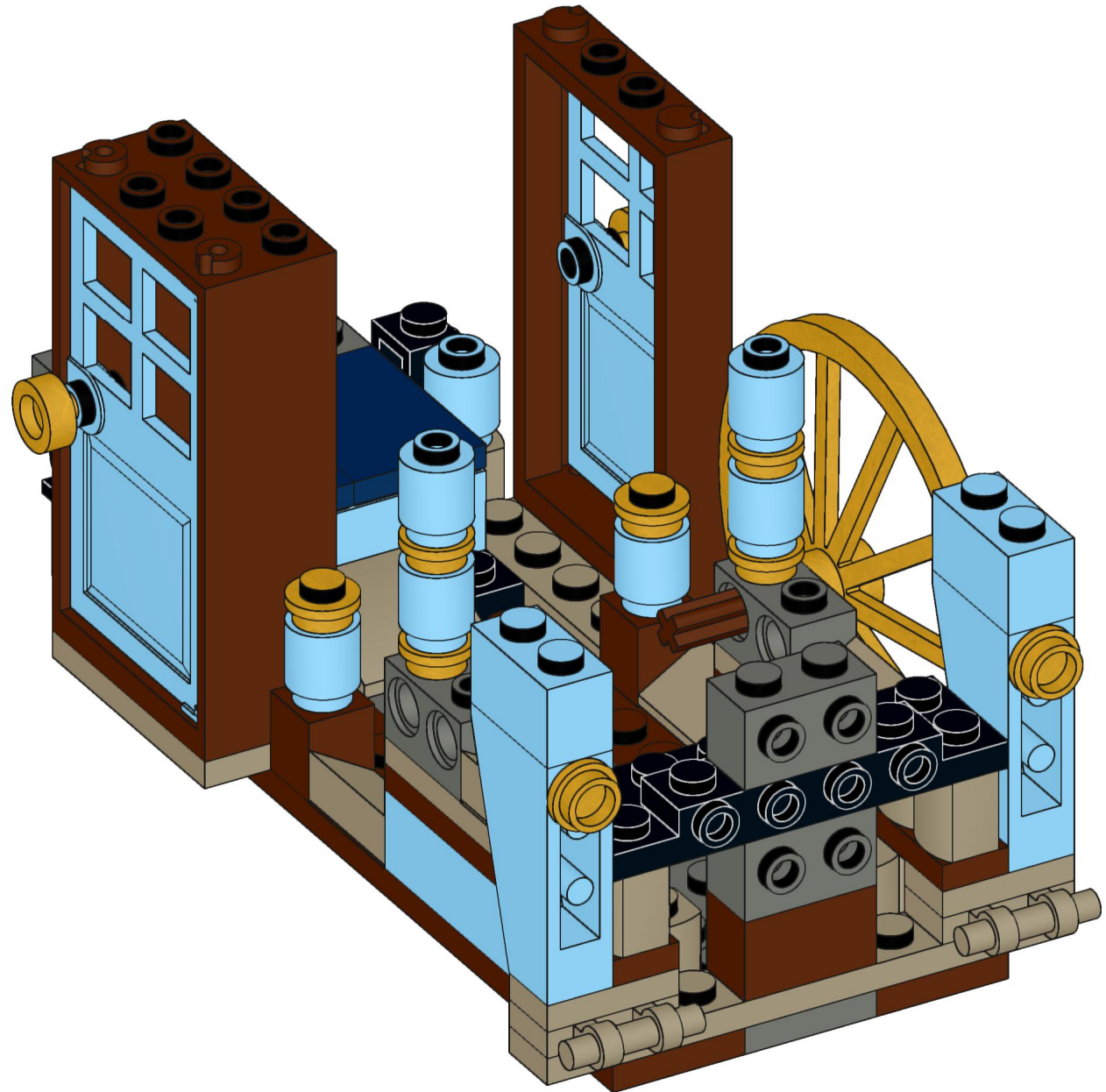
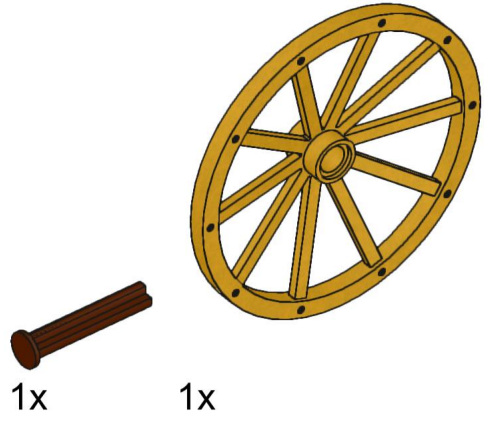

10



1x



1x

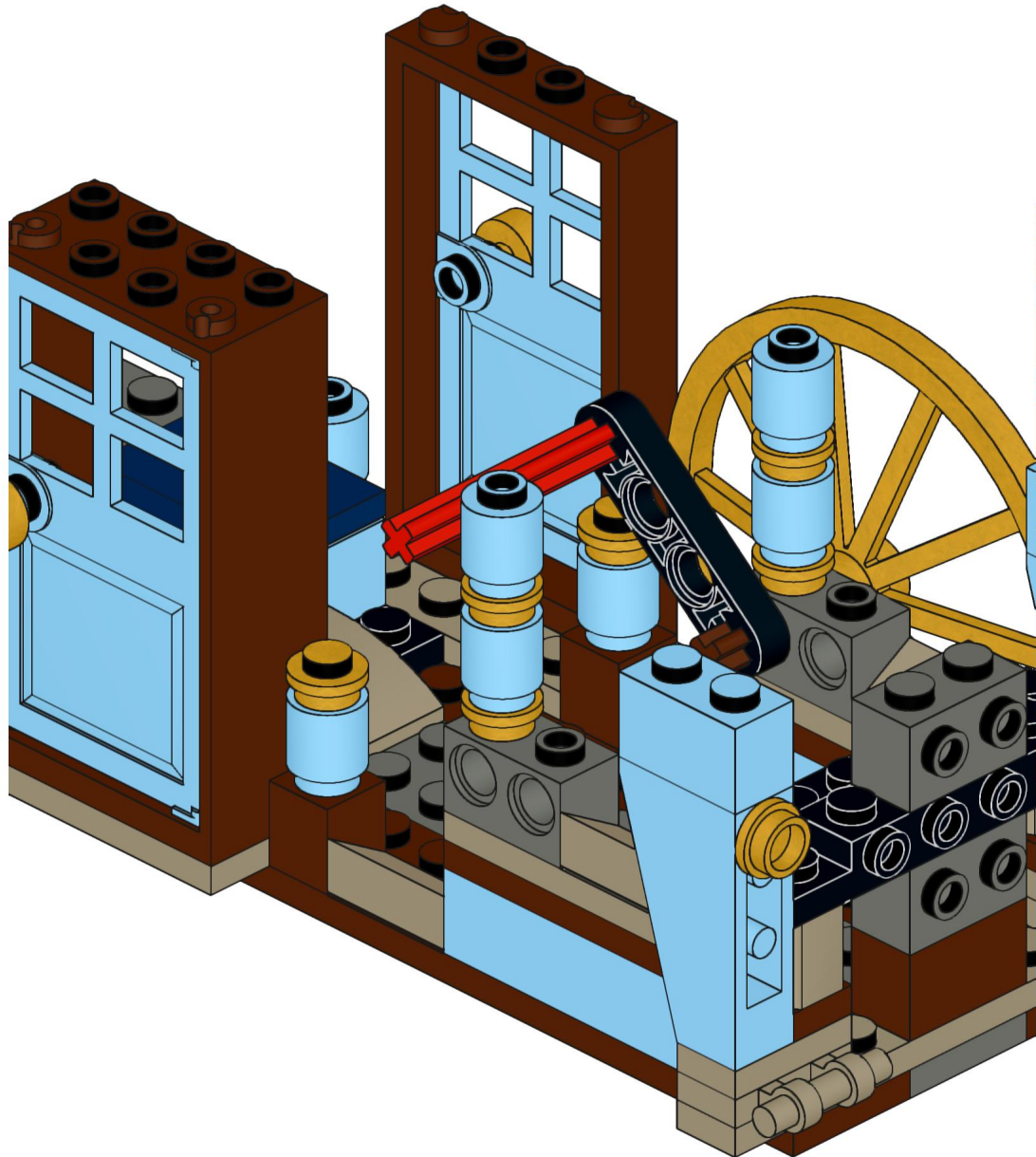

11



1x

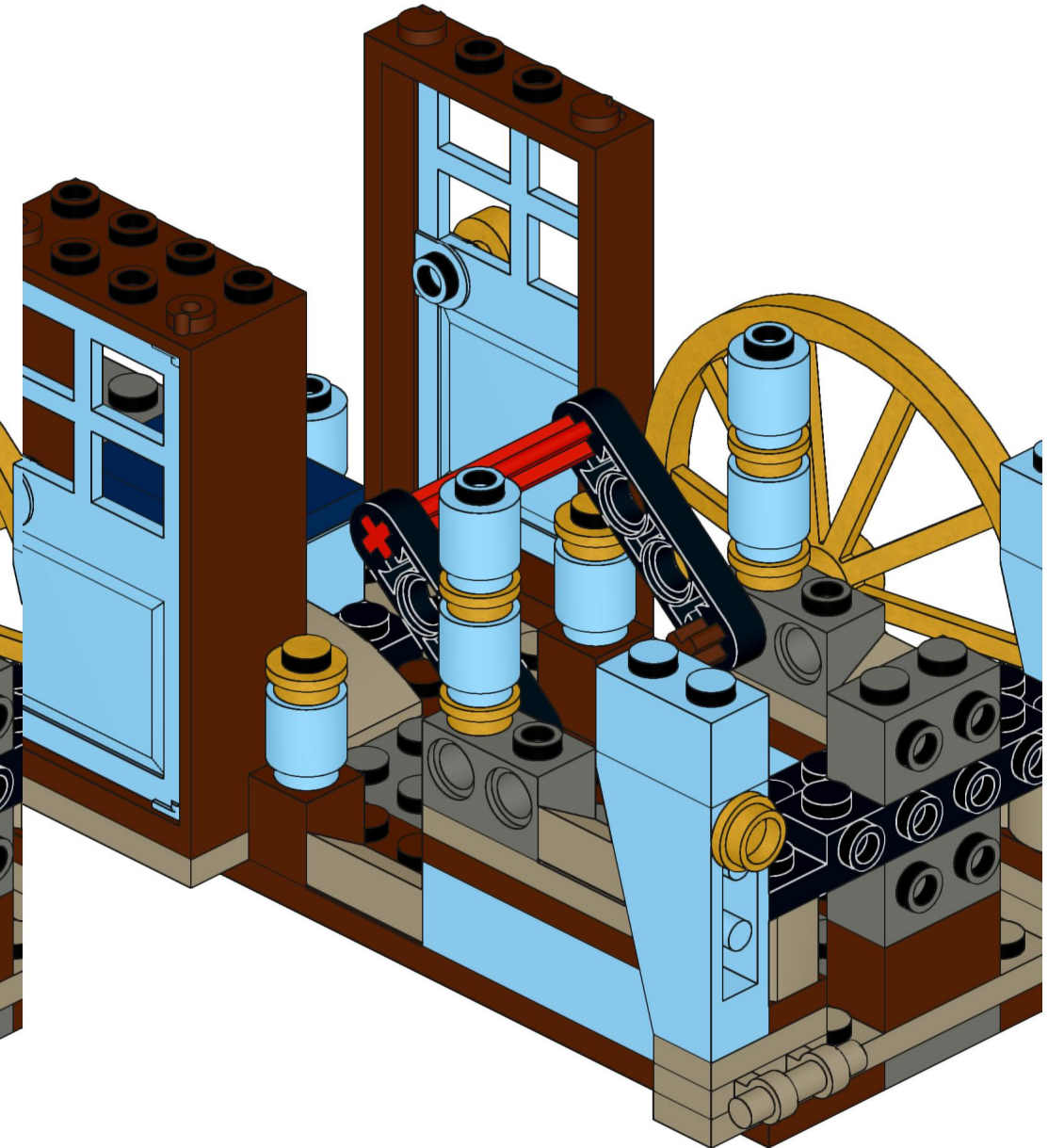

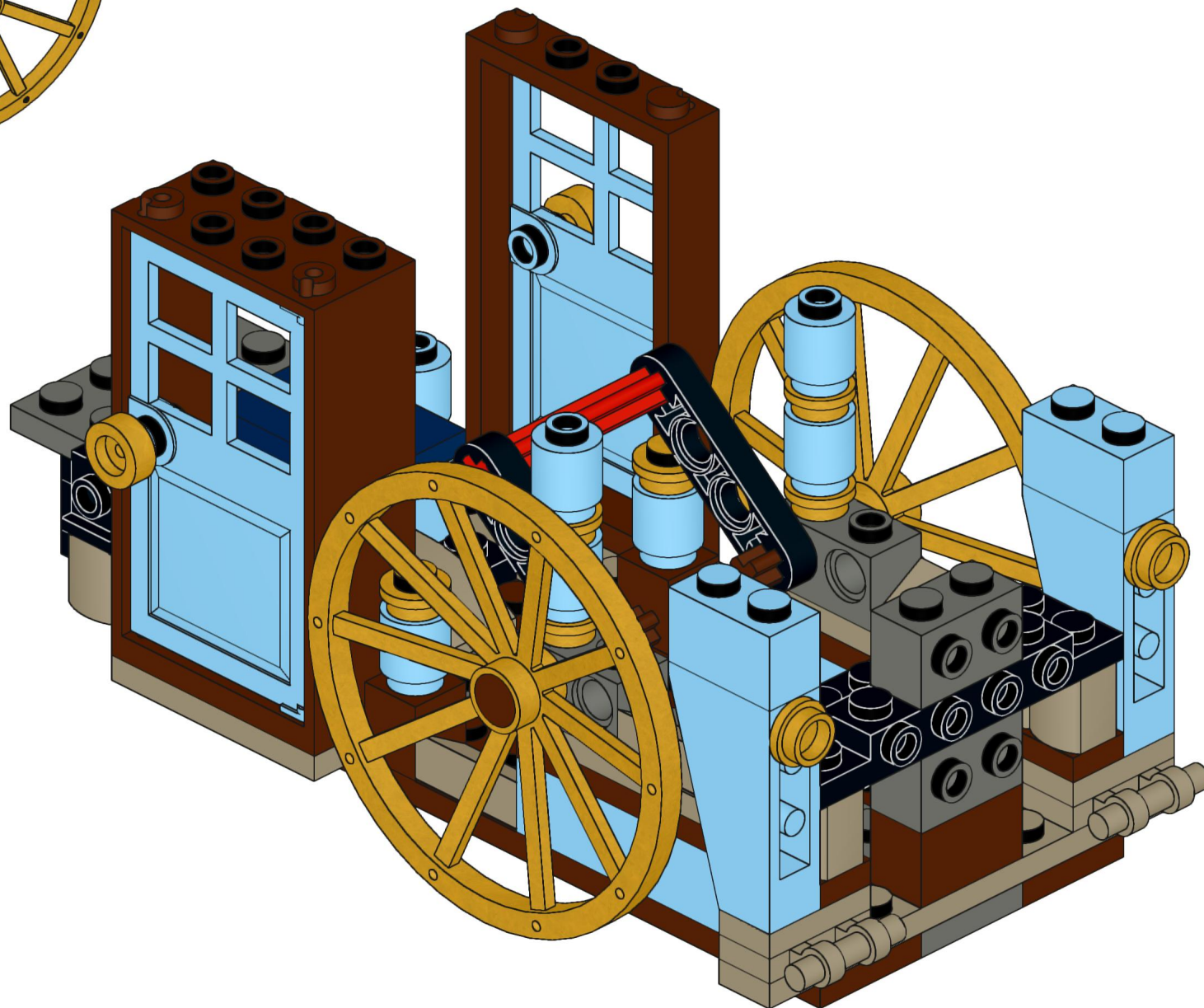
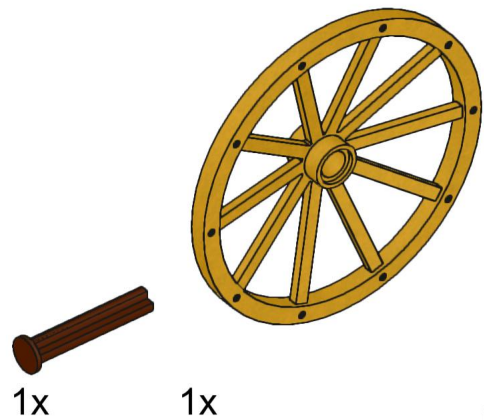

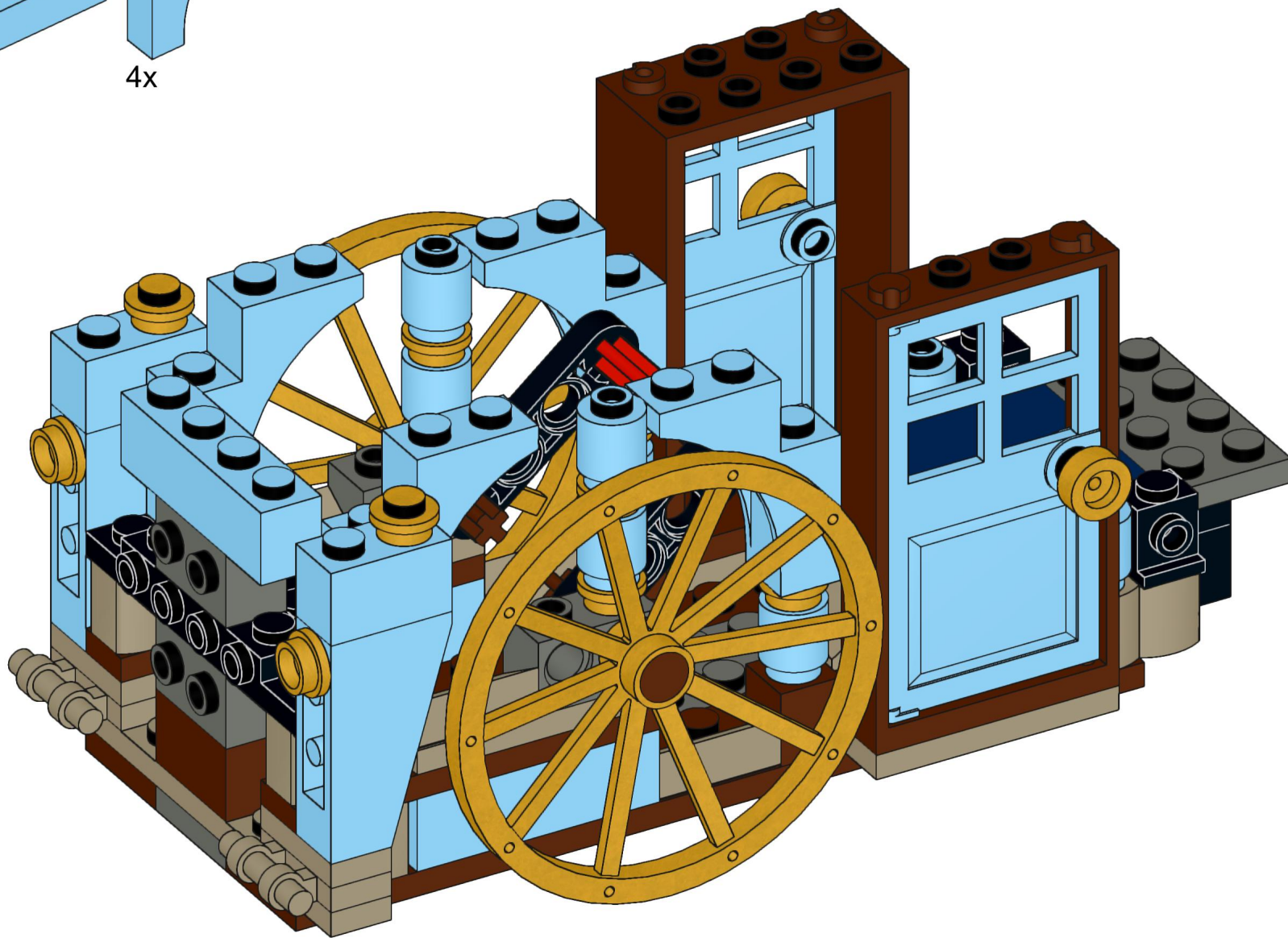
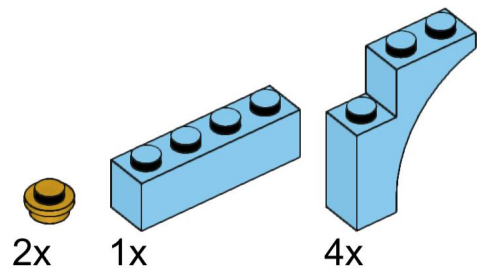

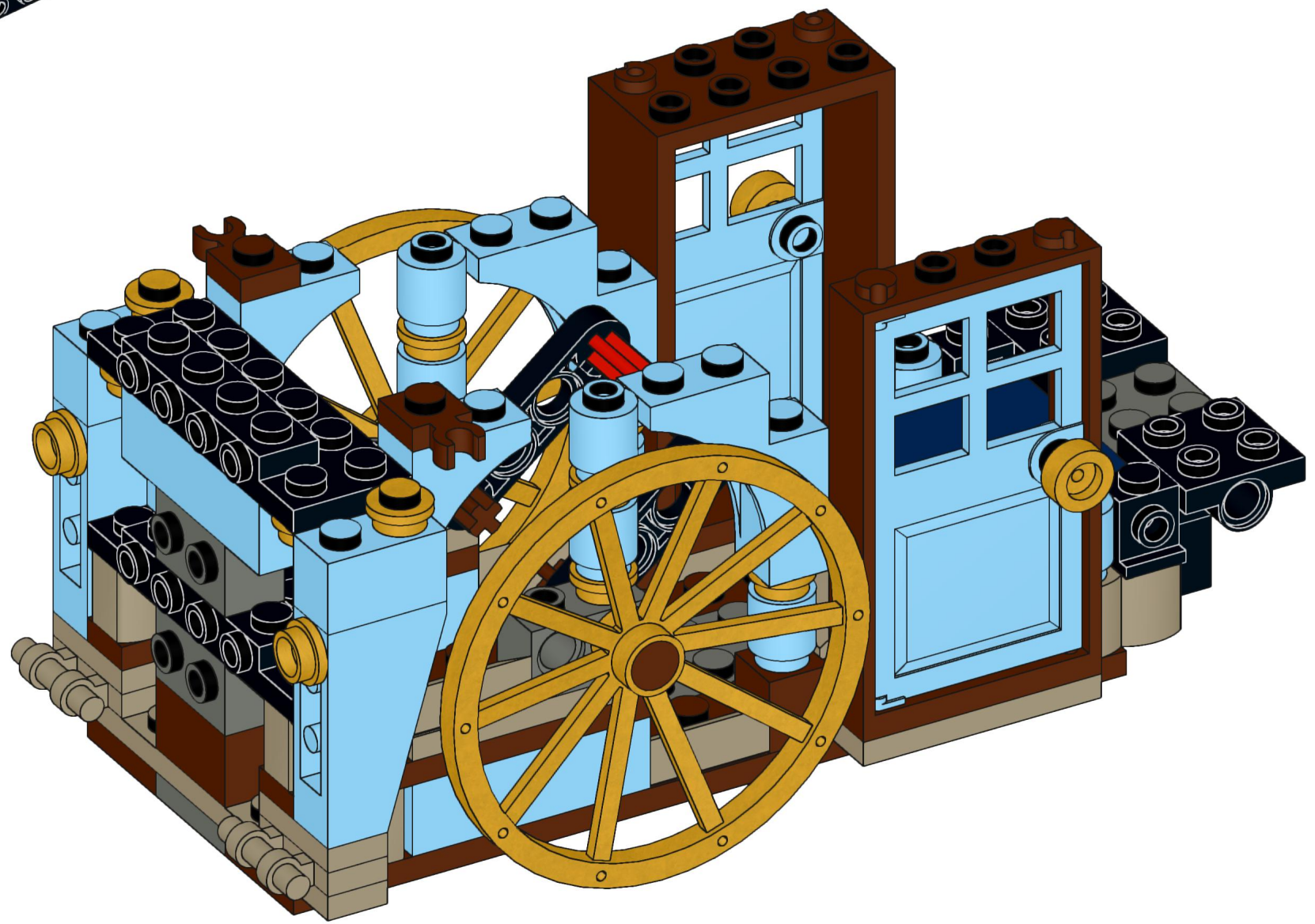
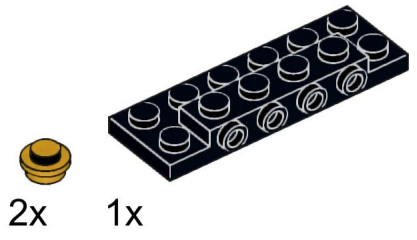

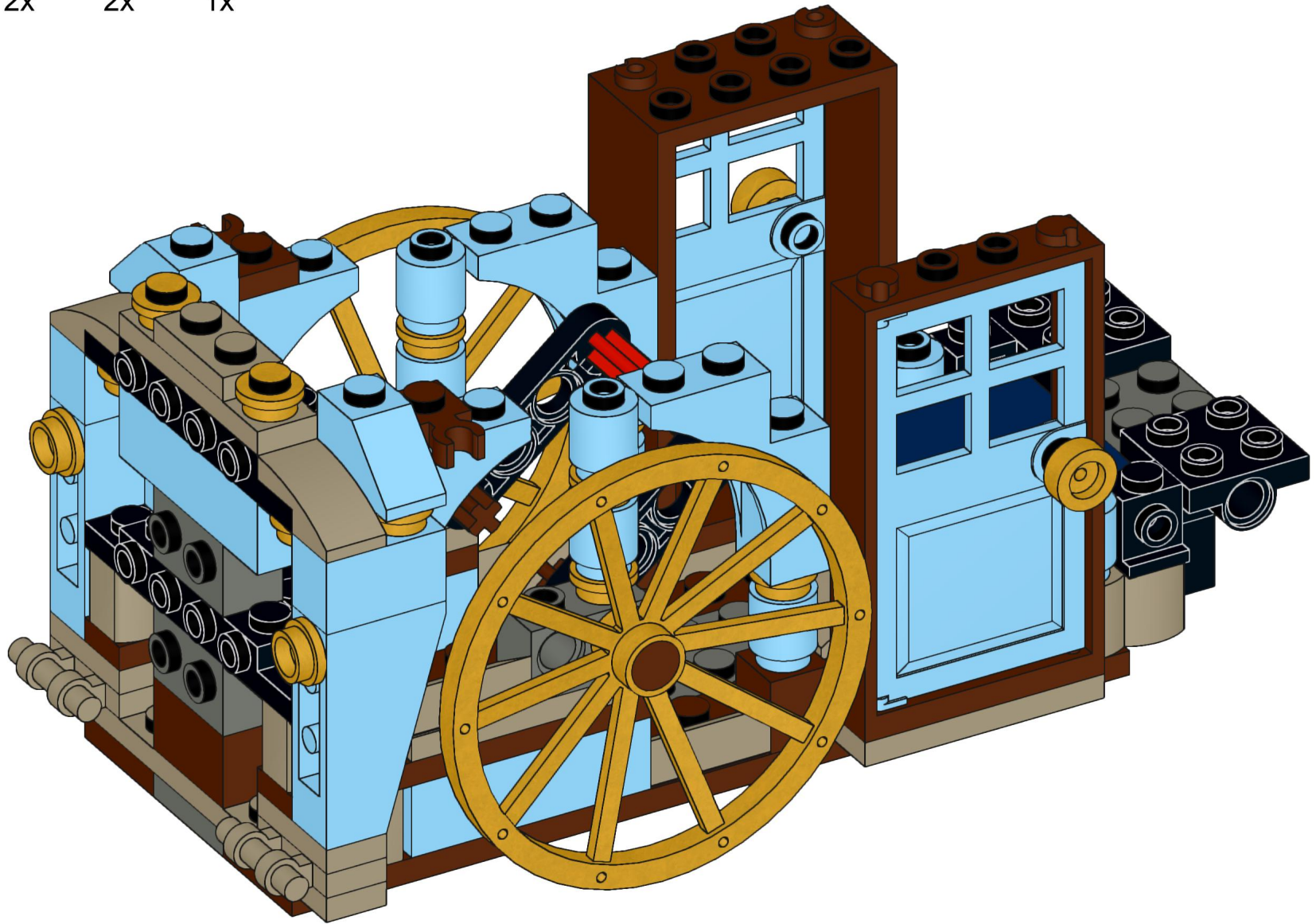
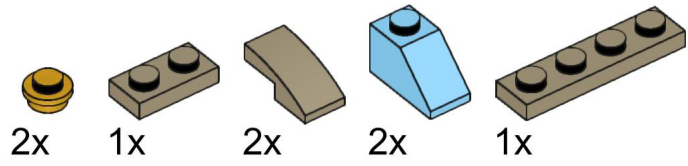

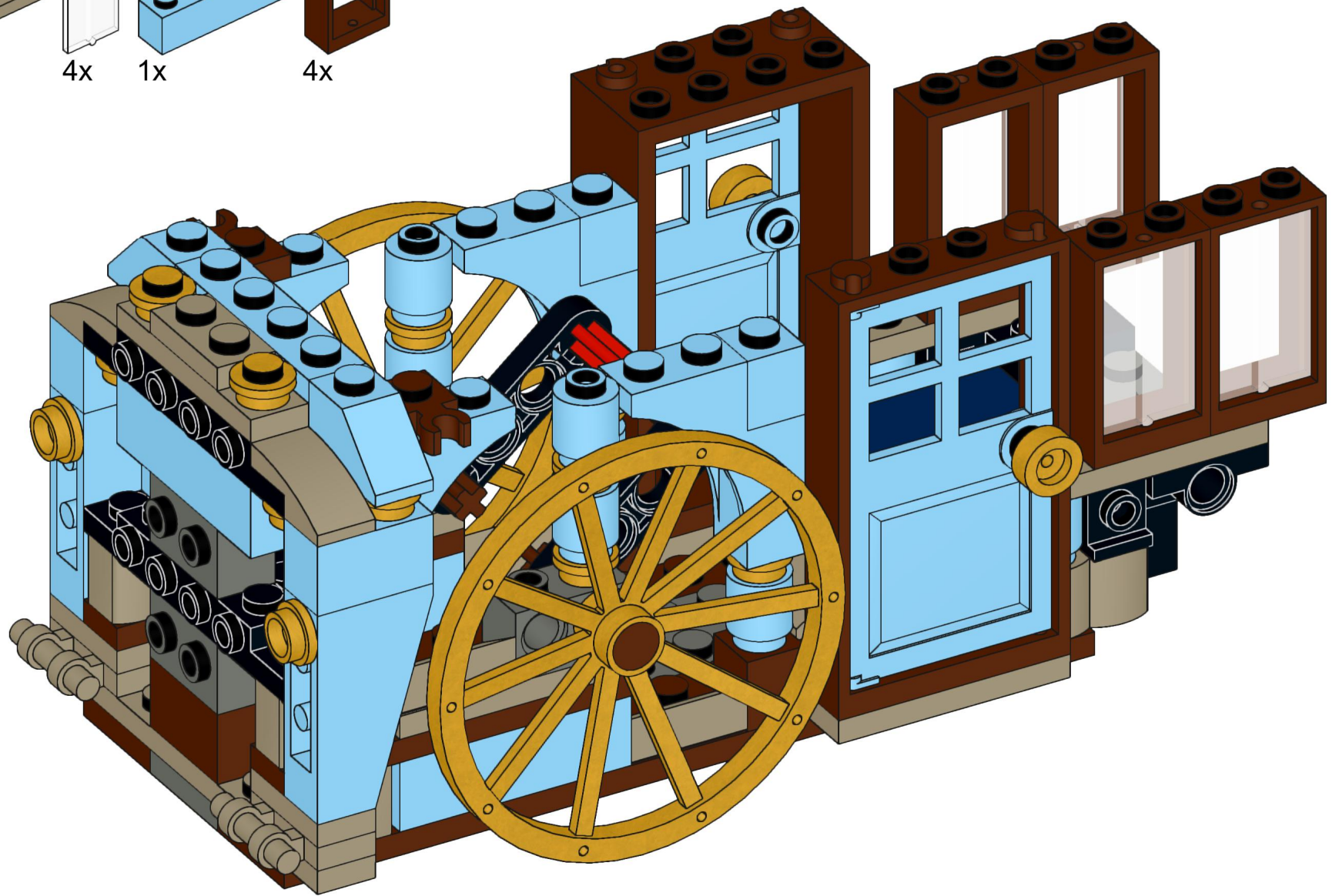
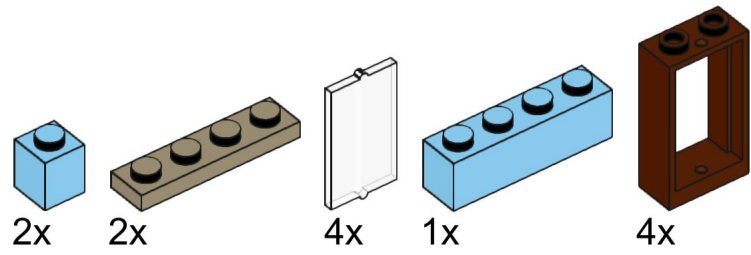

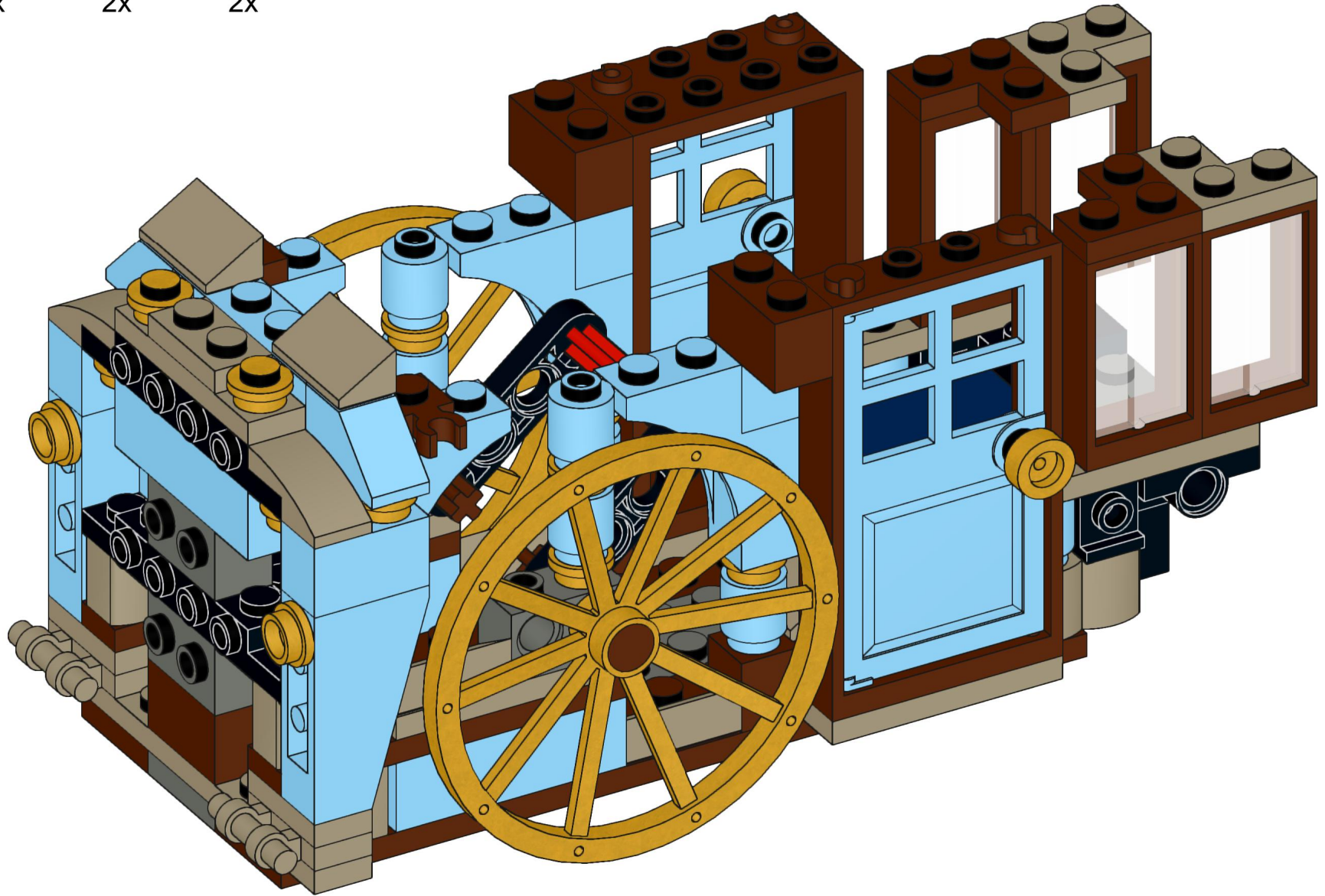
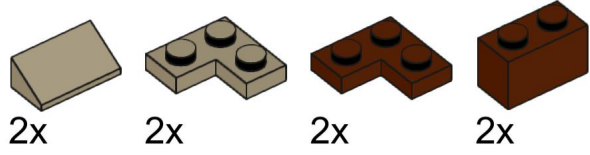

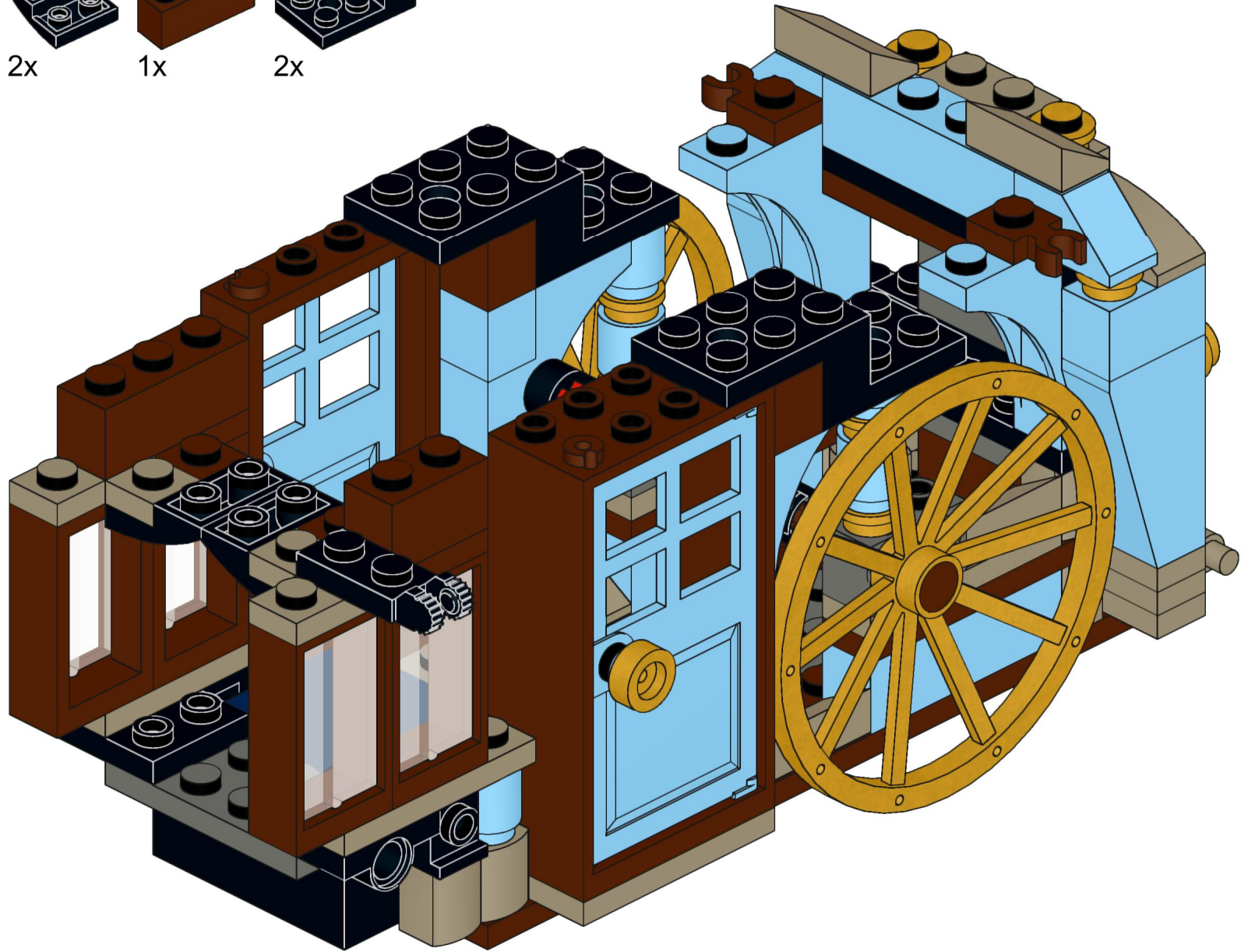
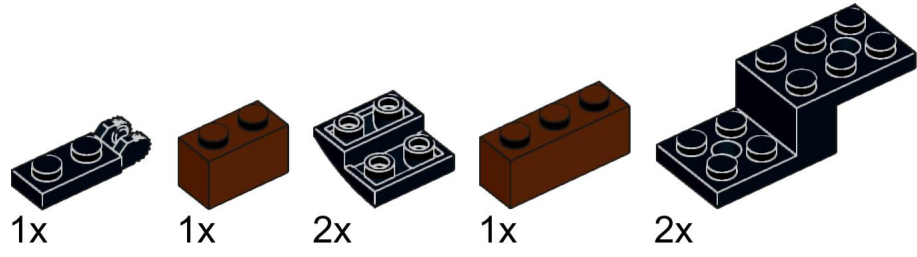

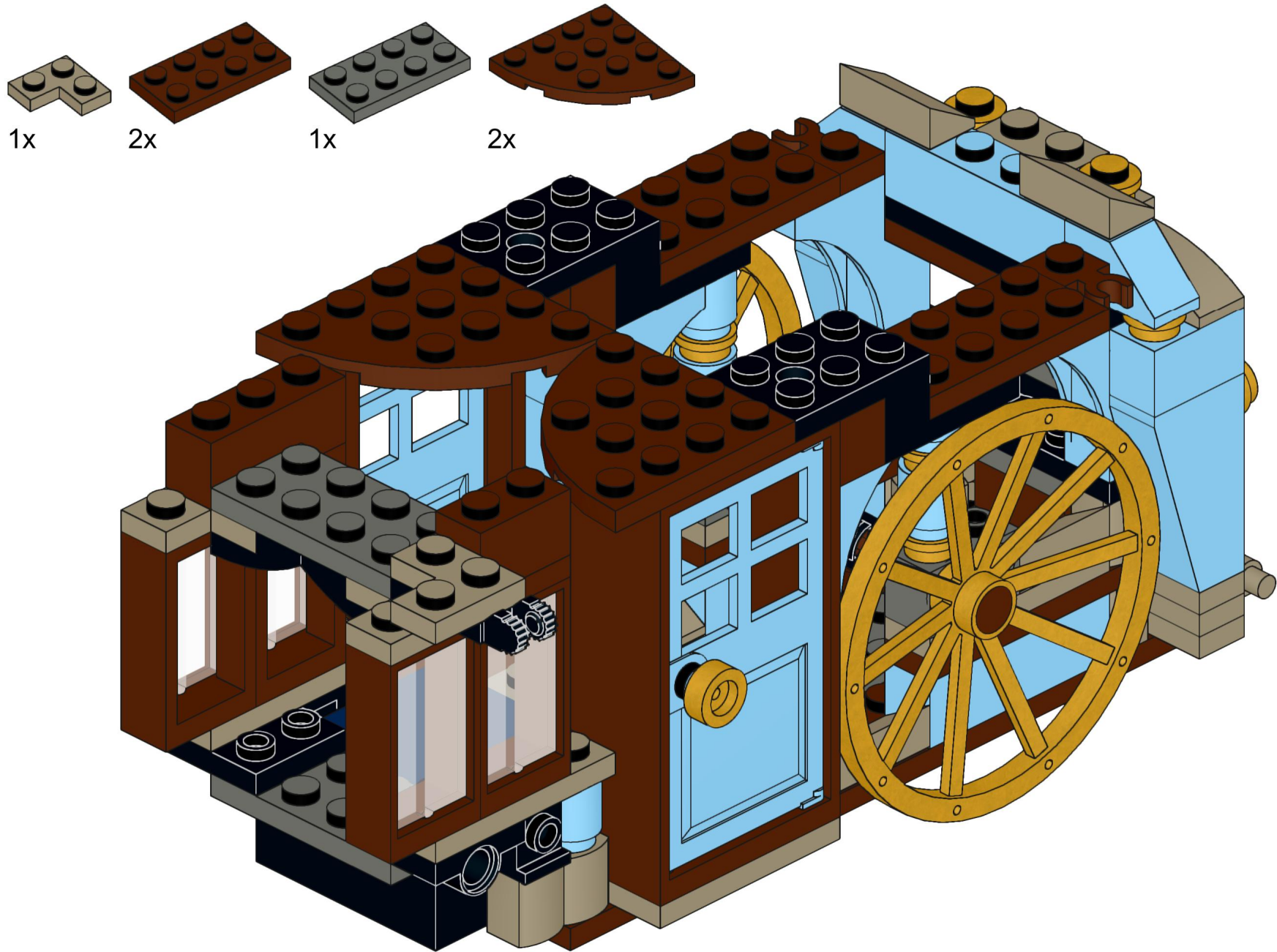

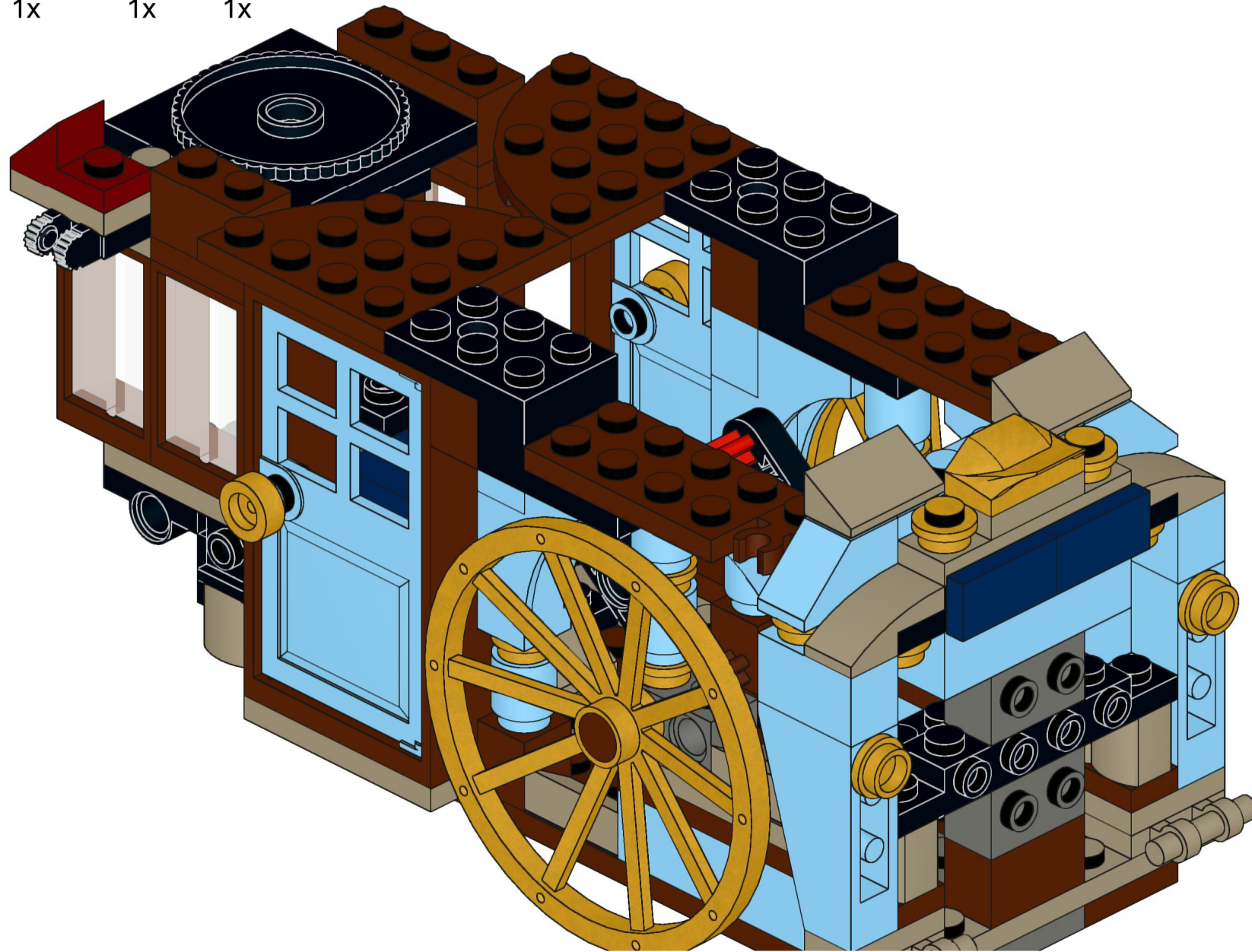
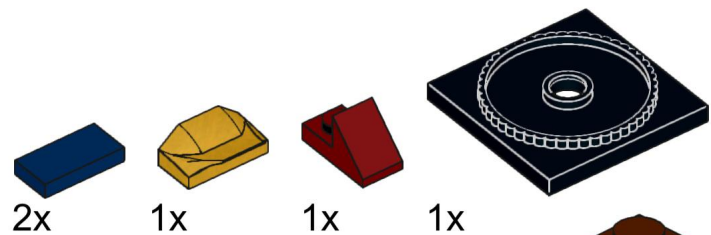



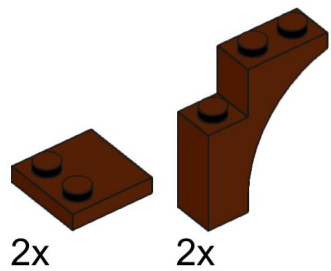

22

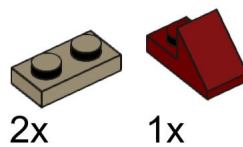



23

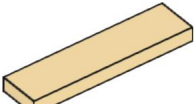

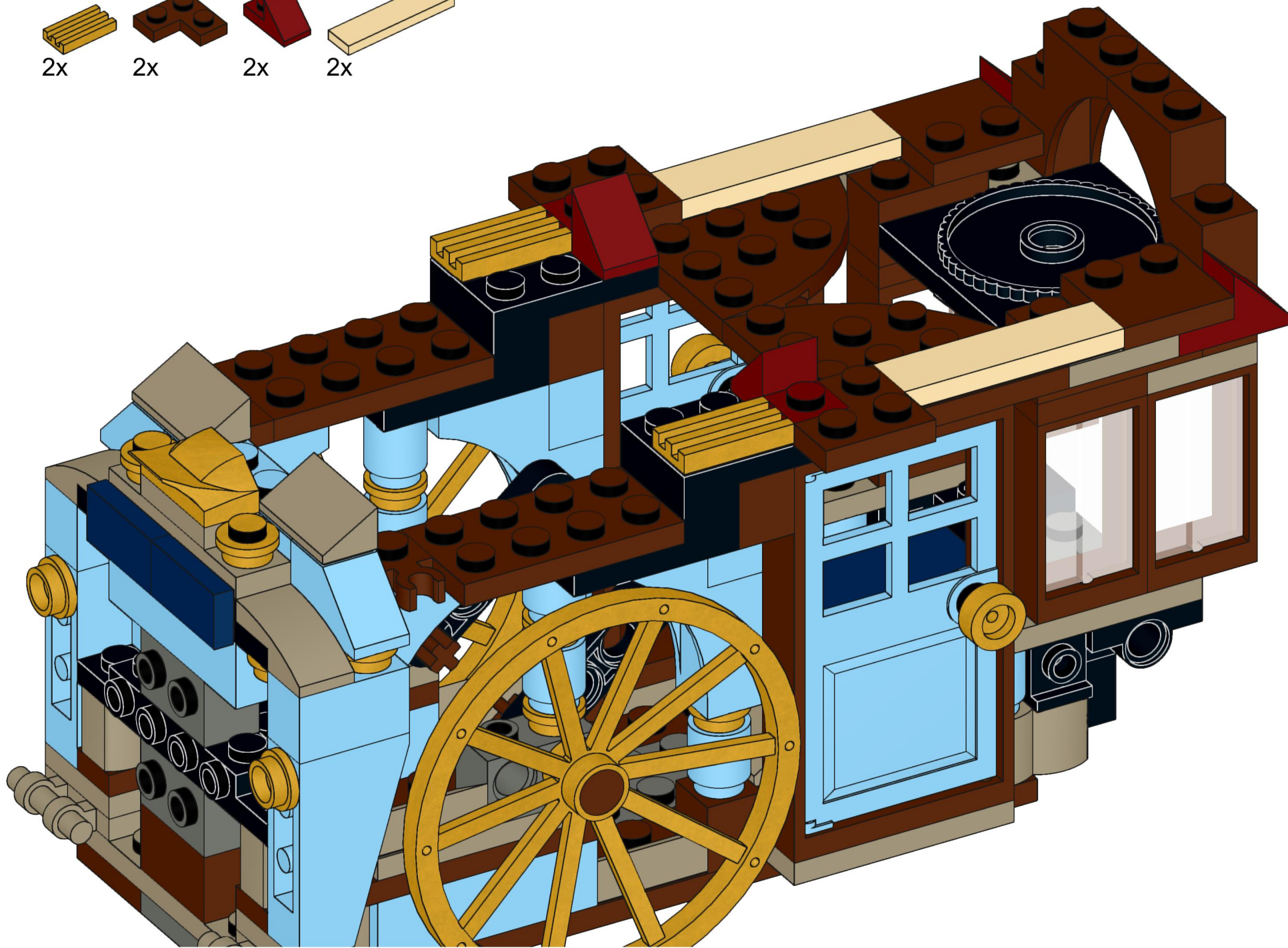
- 2x 
- 2x 
- 2x 
- 2x 

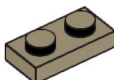

- 1x 
- 1x 
- 2x 
- 2x 

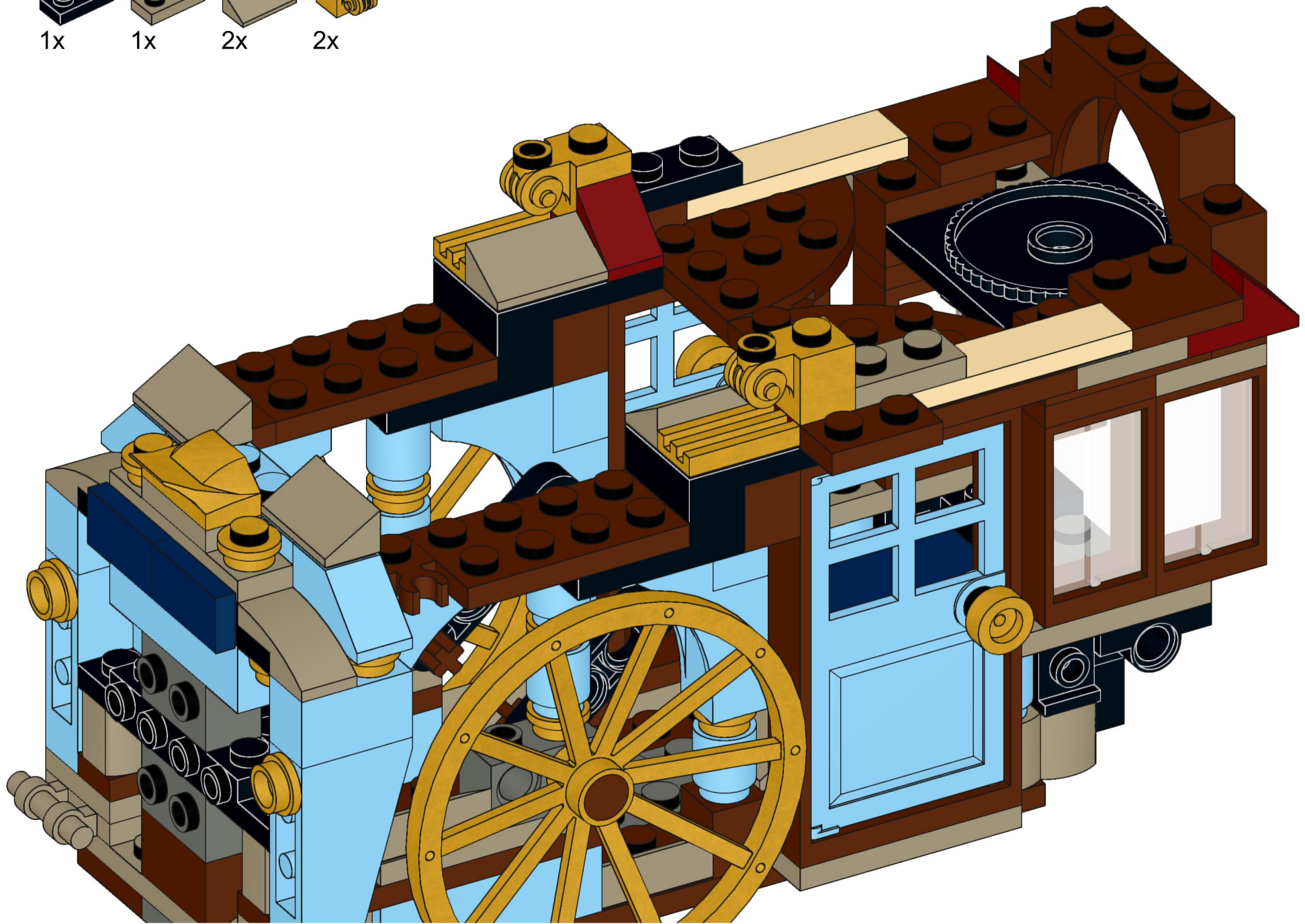

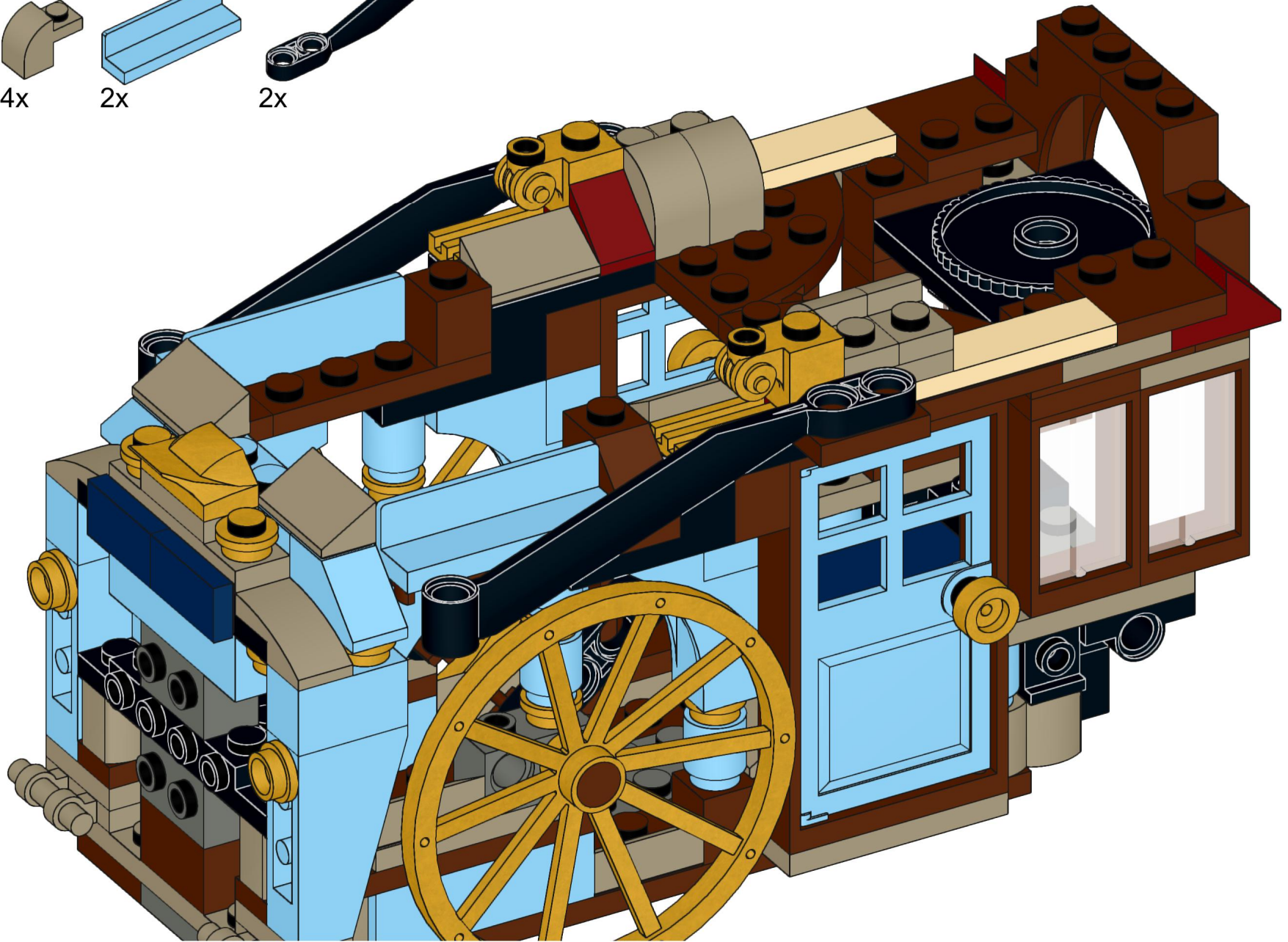
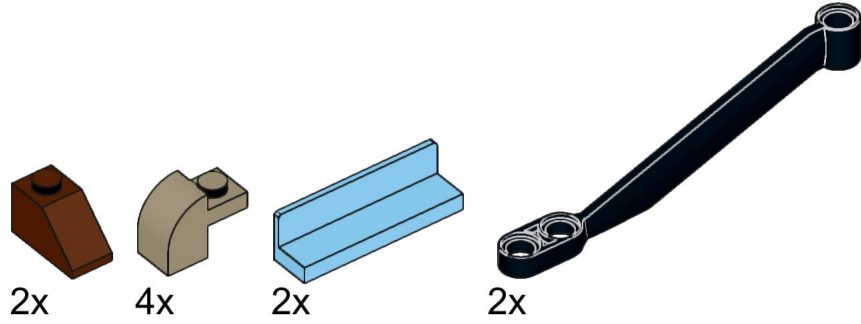

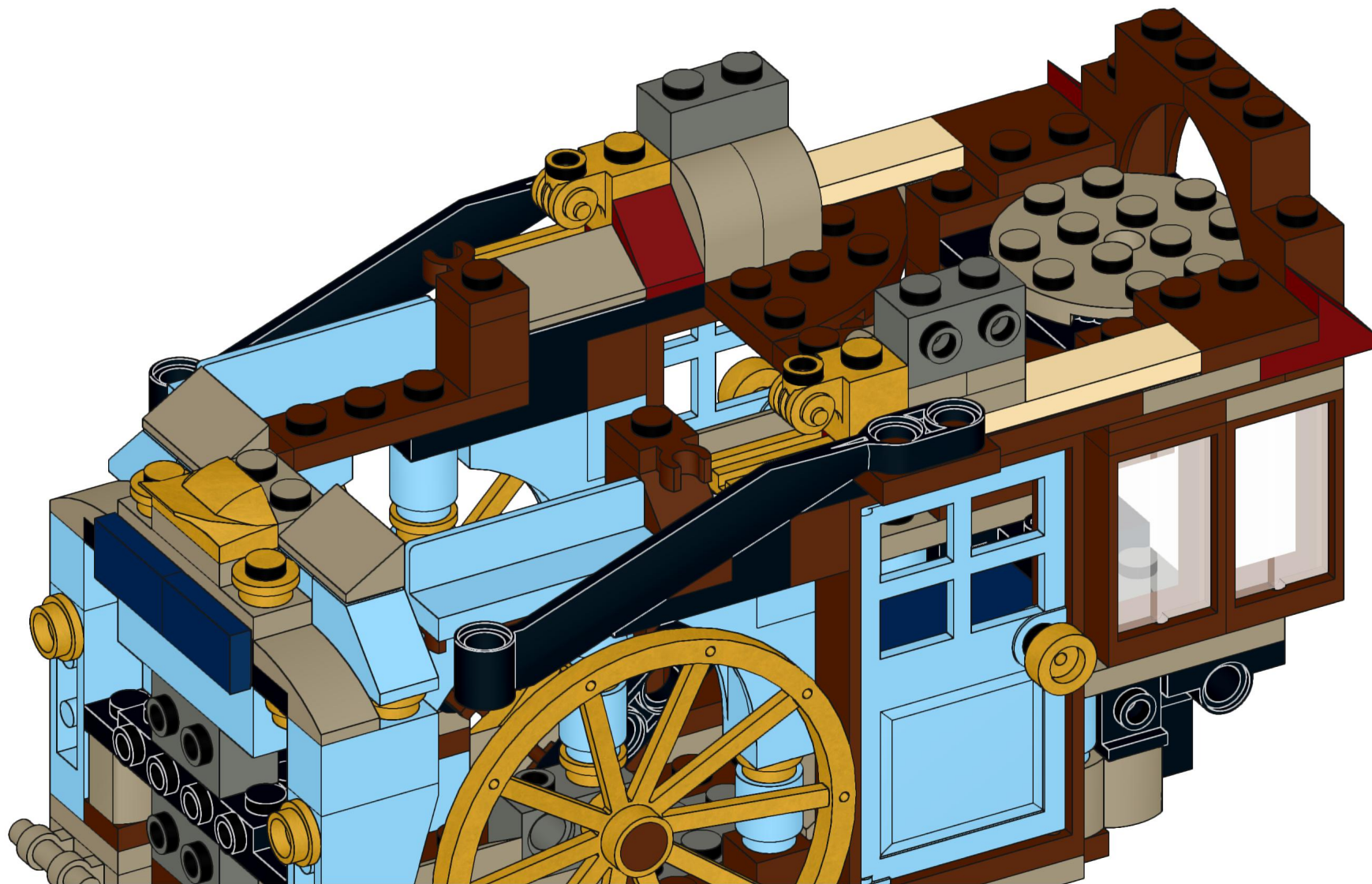
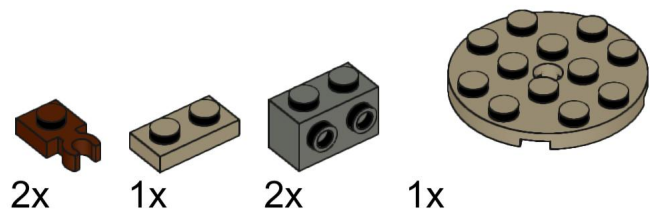

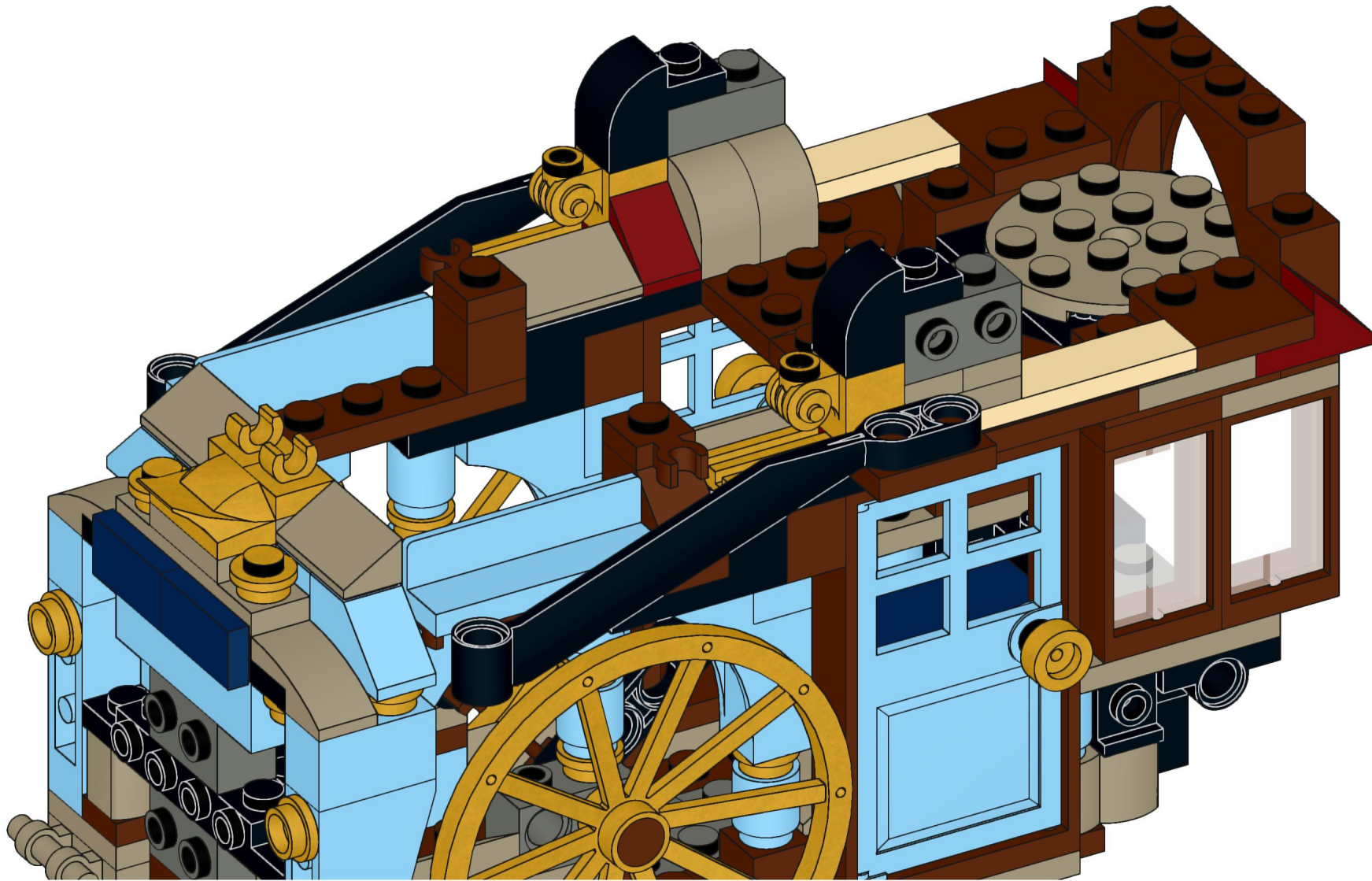
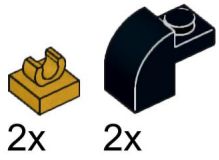

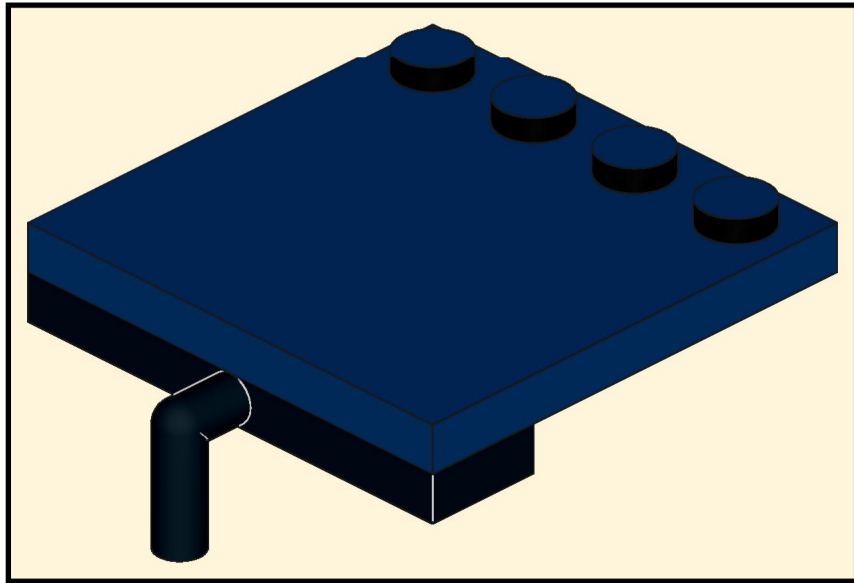

1x

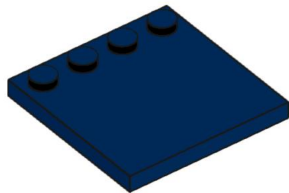

1x

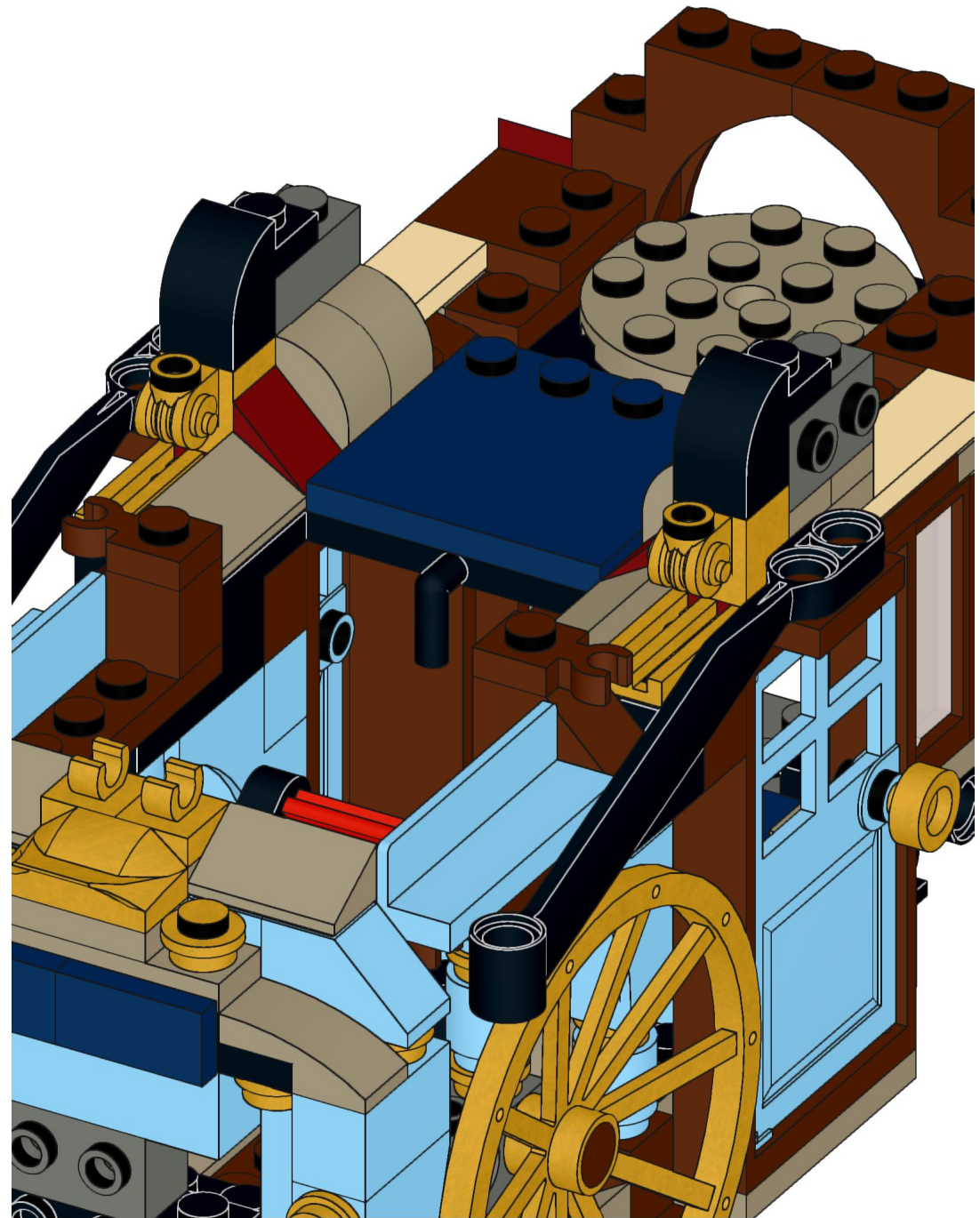
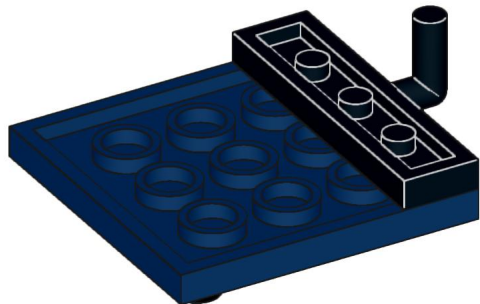



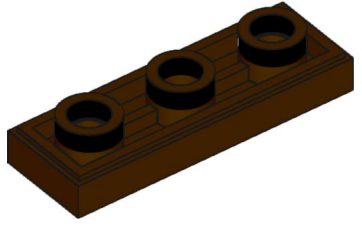

31

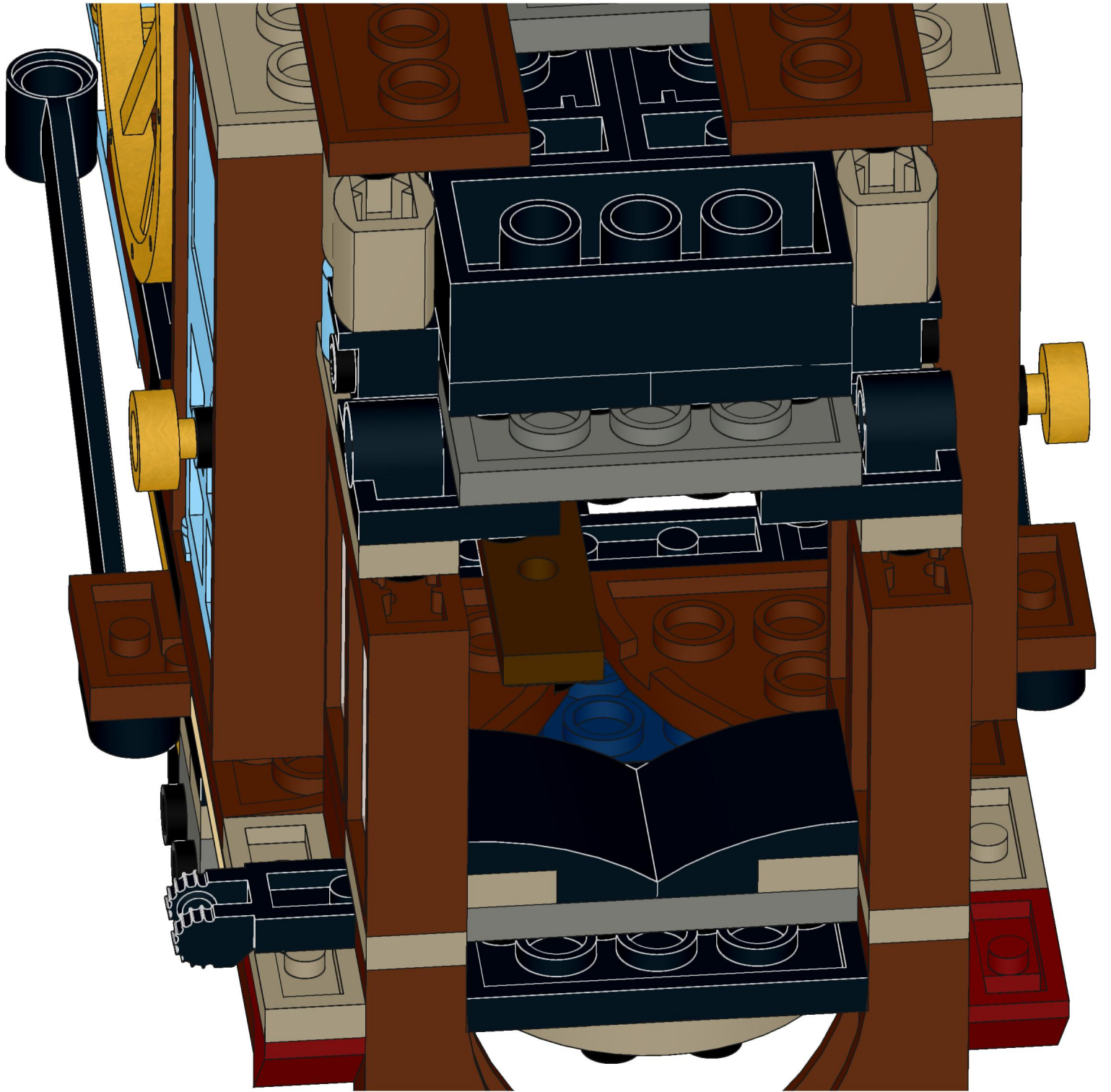

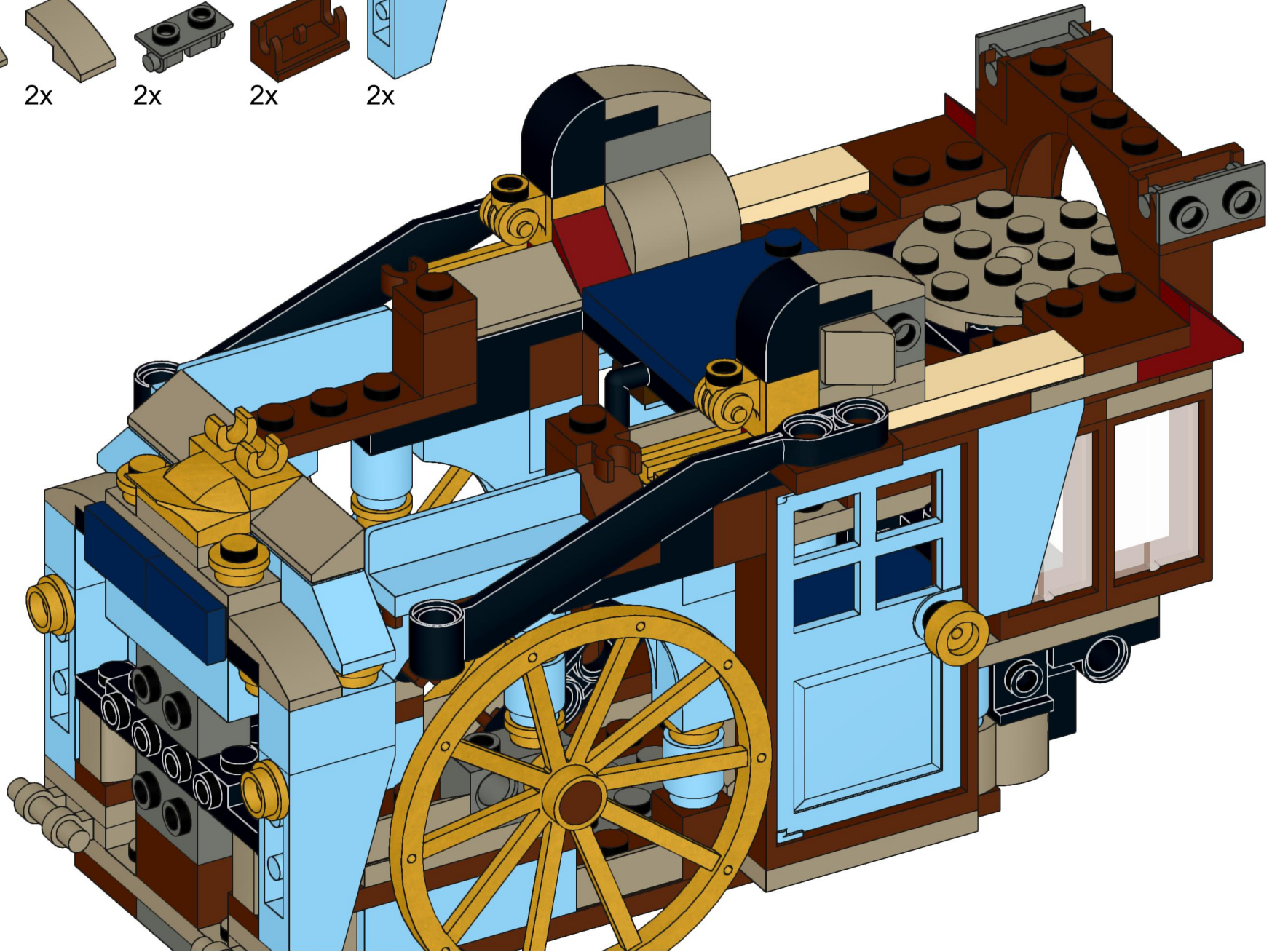
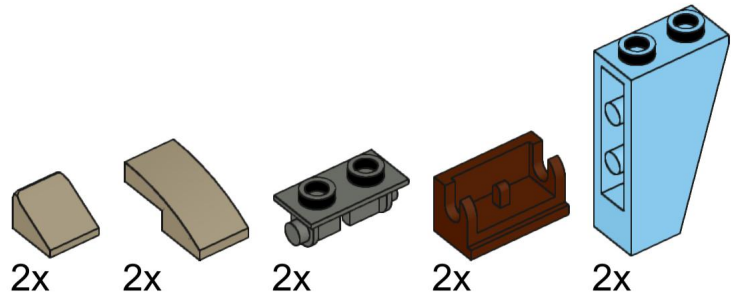

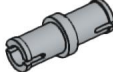

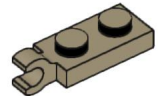
1x



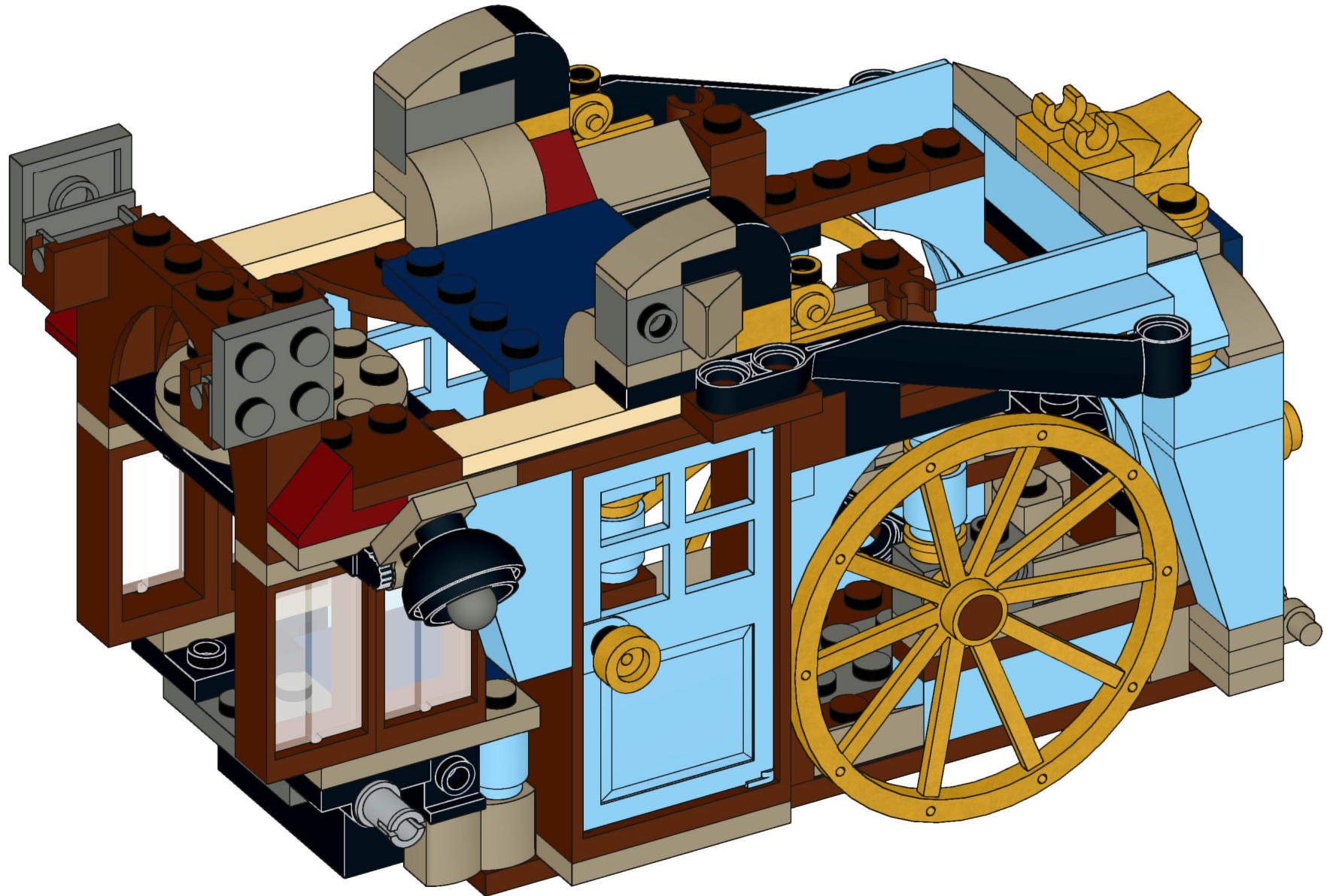

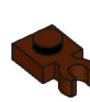
- 2x 
- 2x 
- 1x 
- 1x 
- 1x 



- 2x 
- 1x 
- 2x 
- 2x 

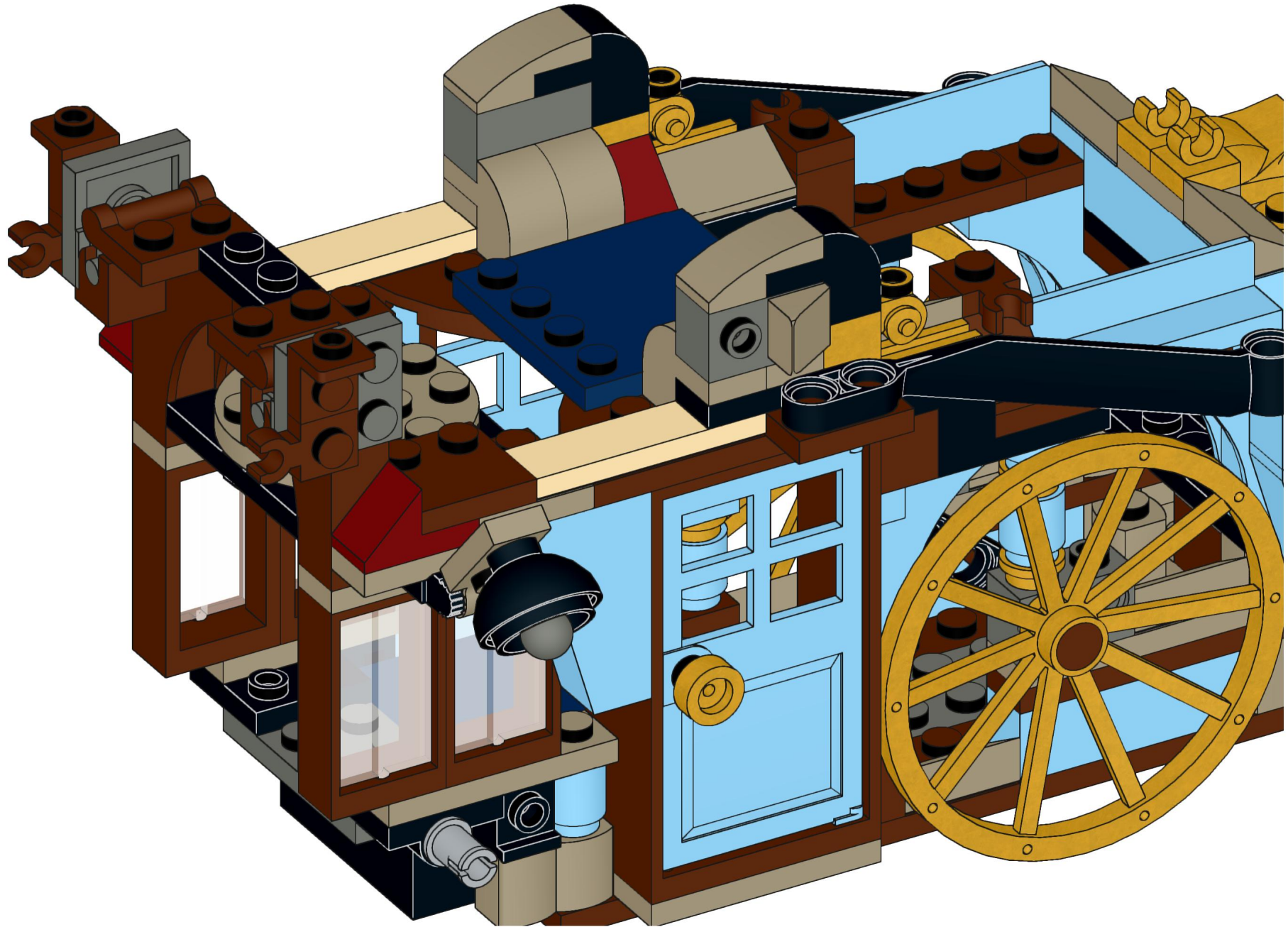

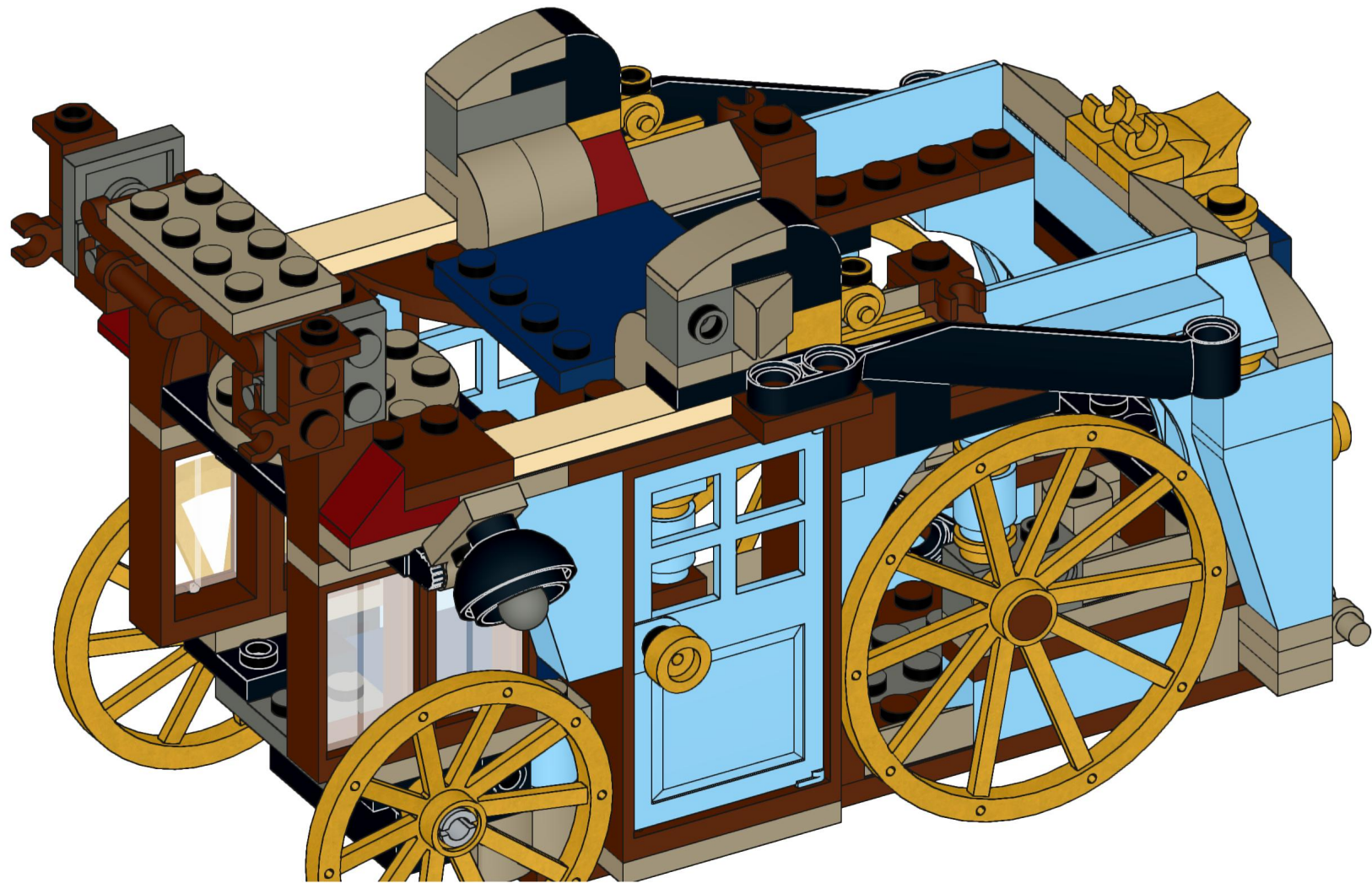
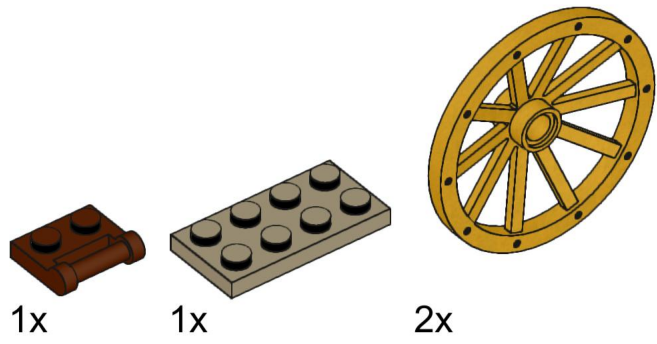

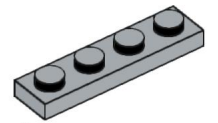

1x

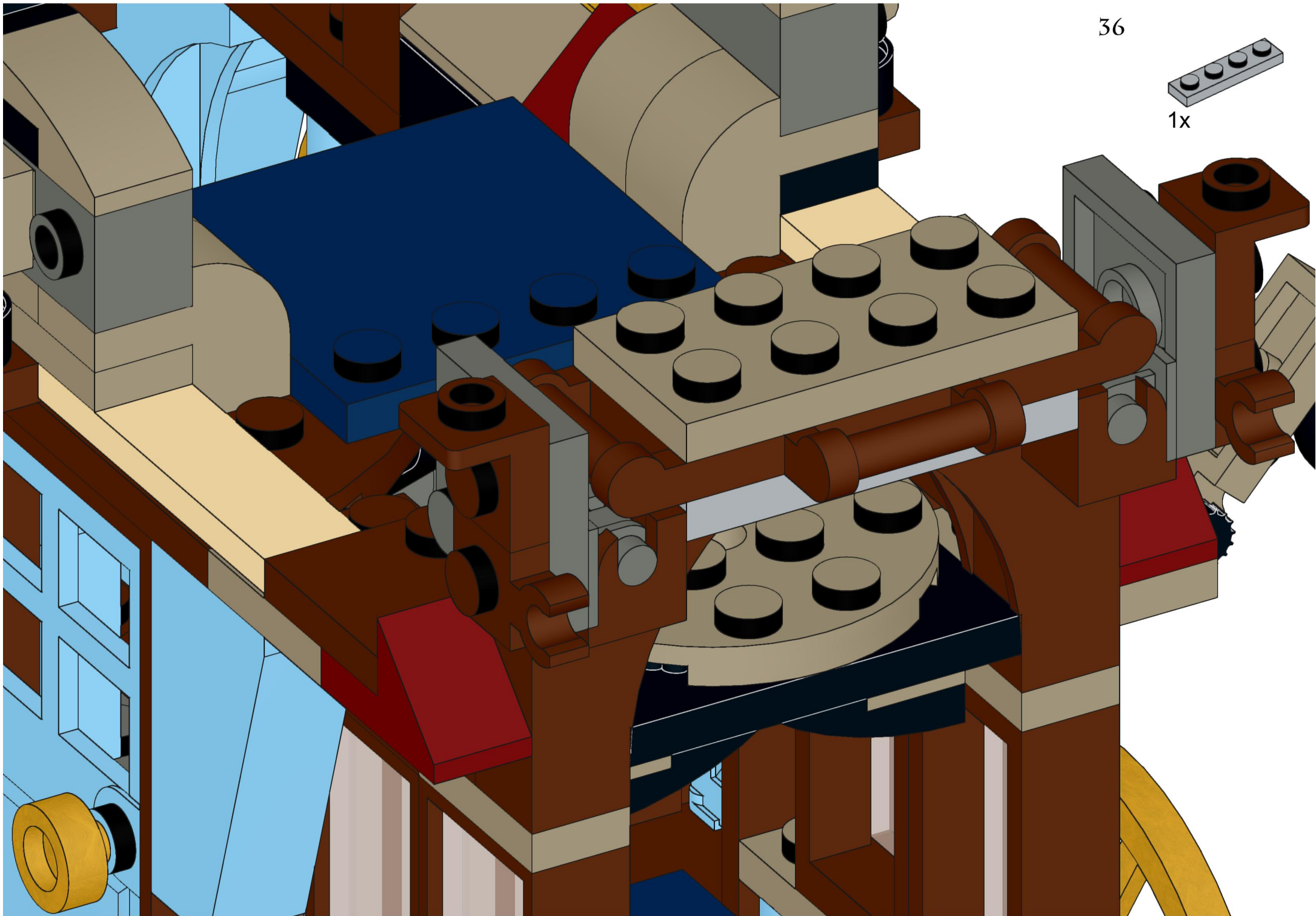

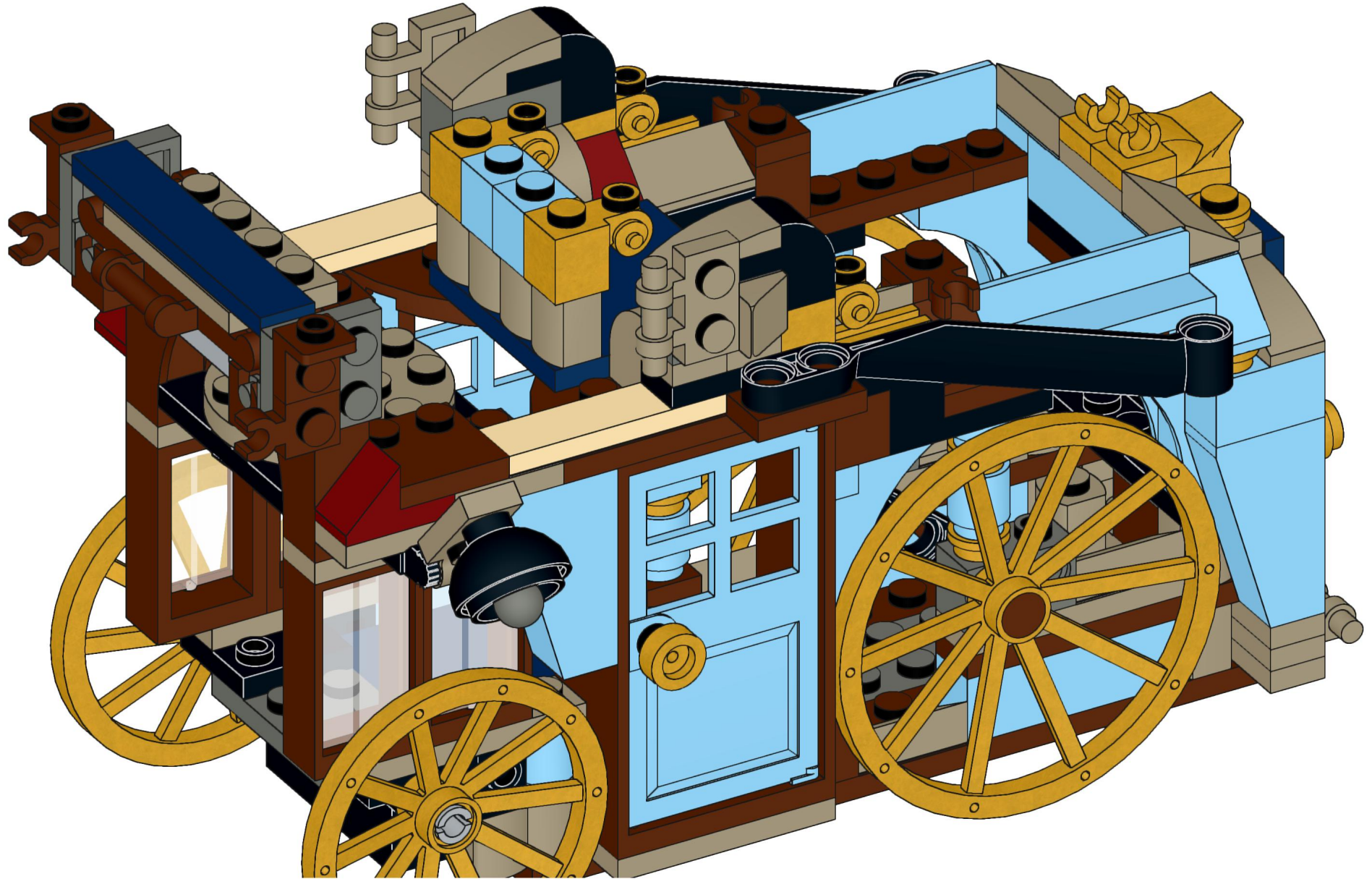
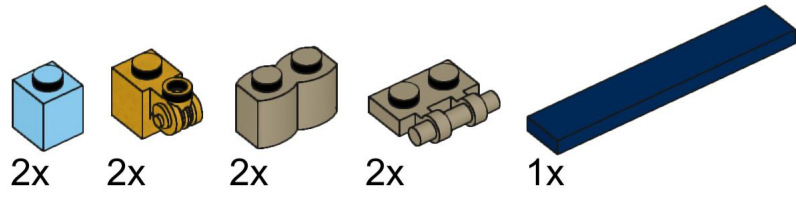

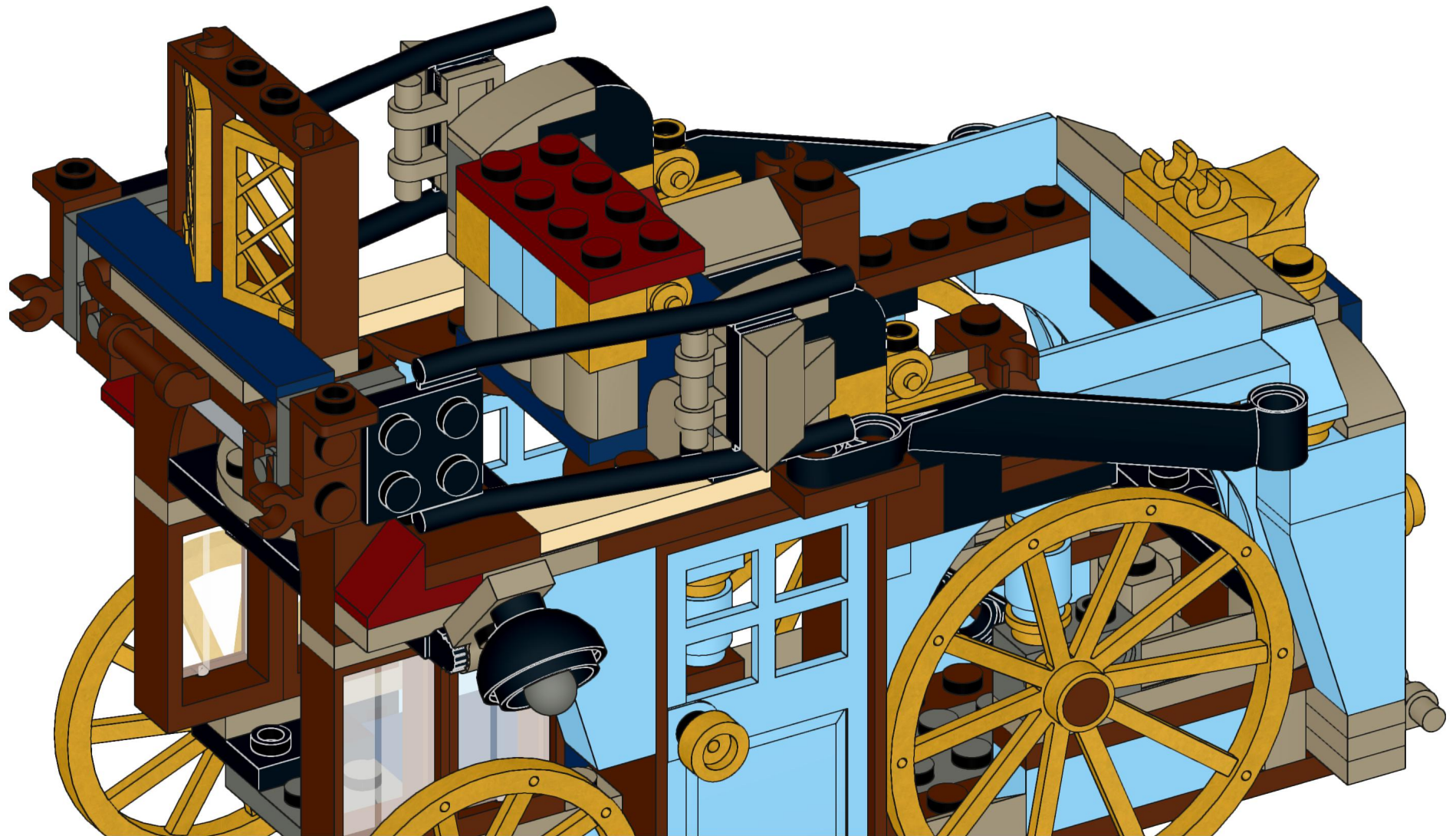
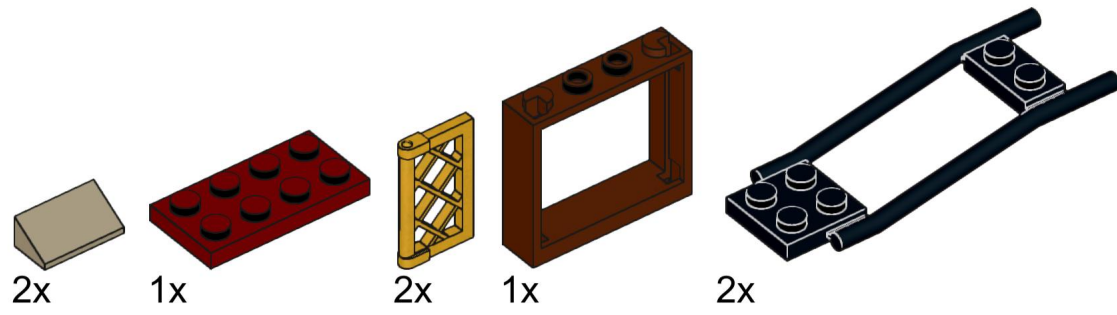

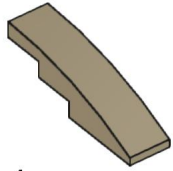

4x

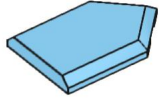

2x

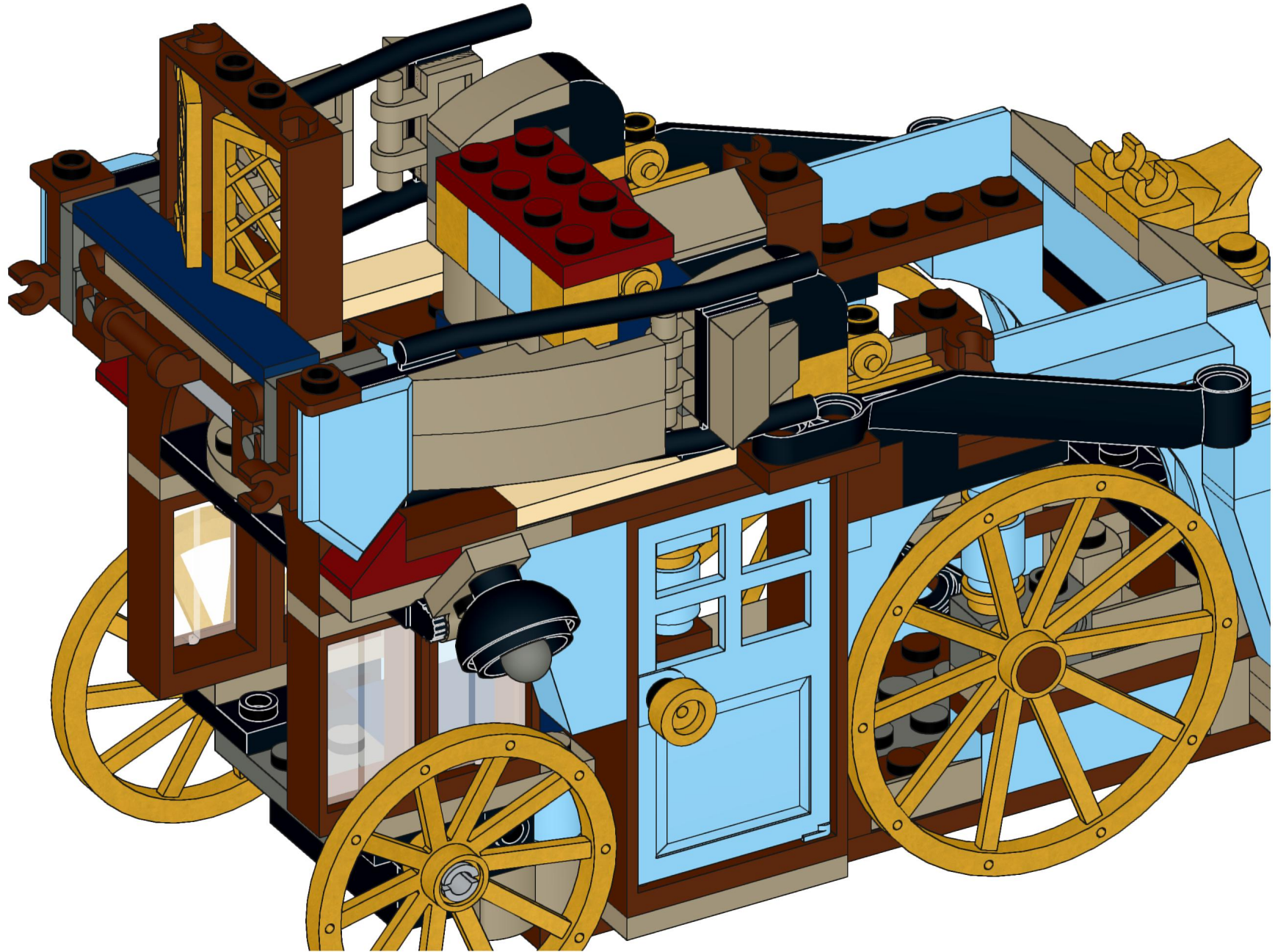

40



2x

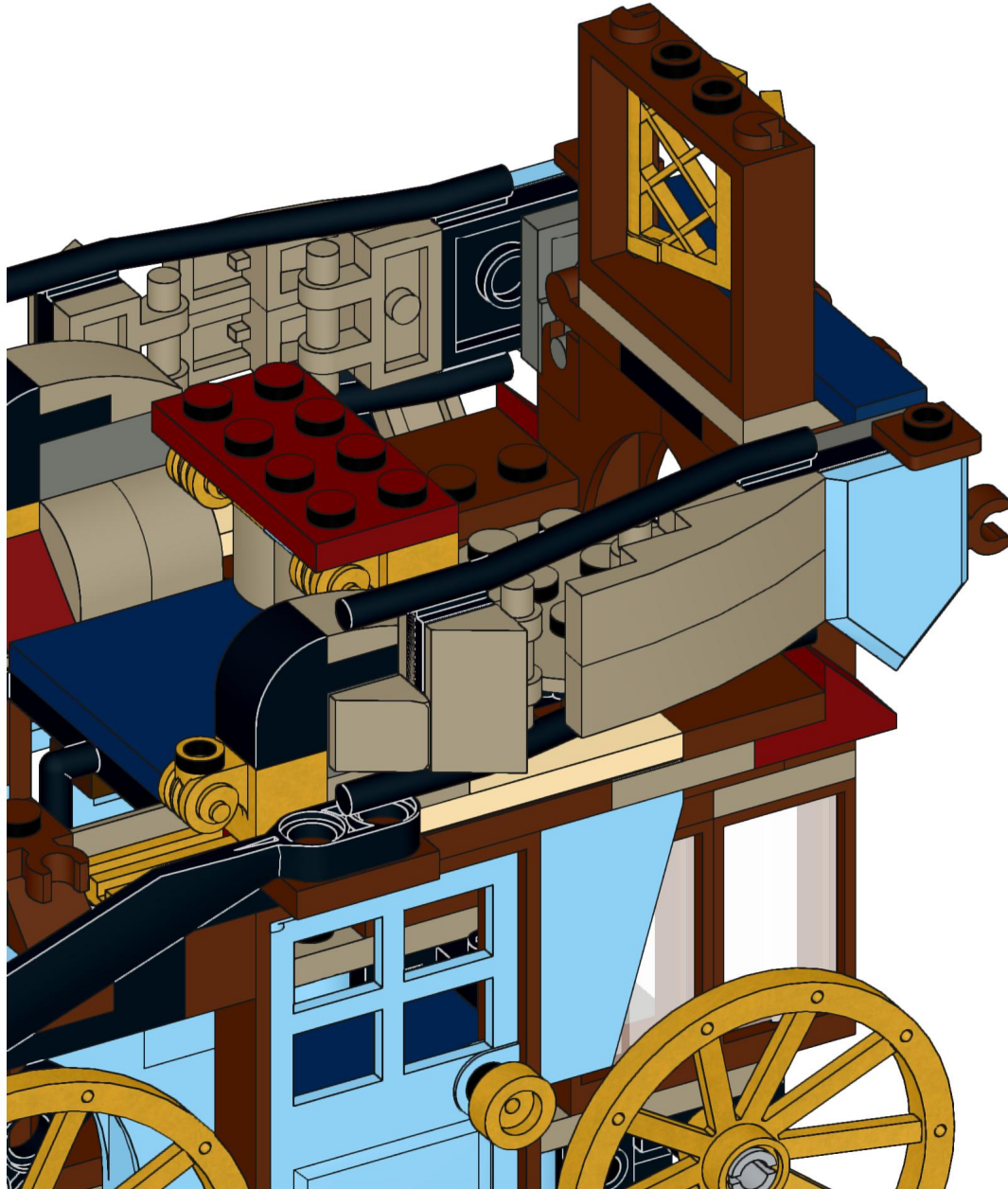

41

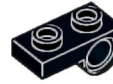

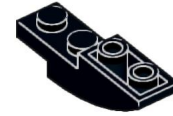

2x



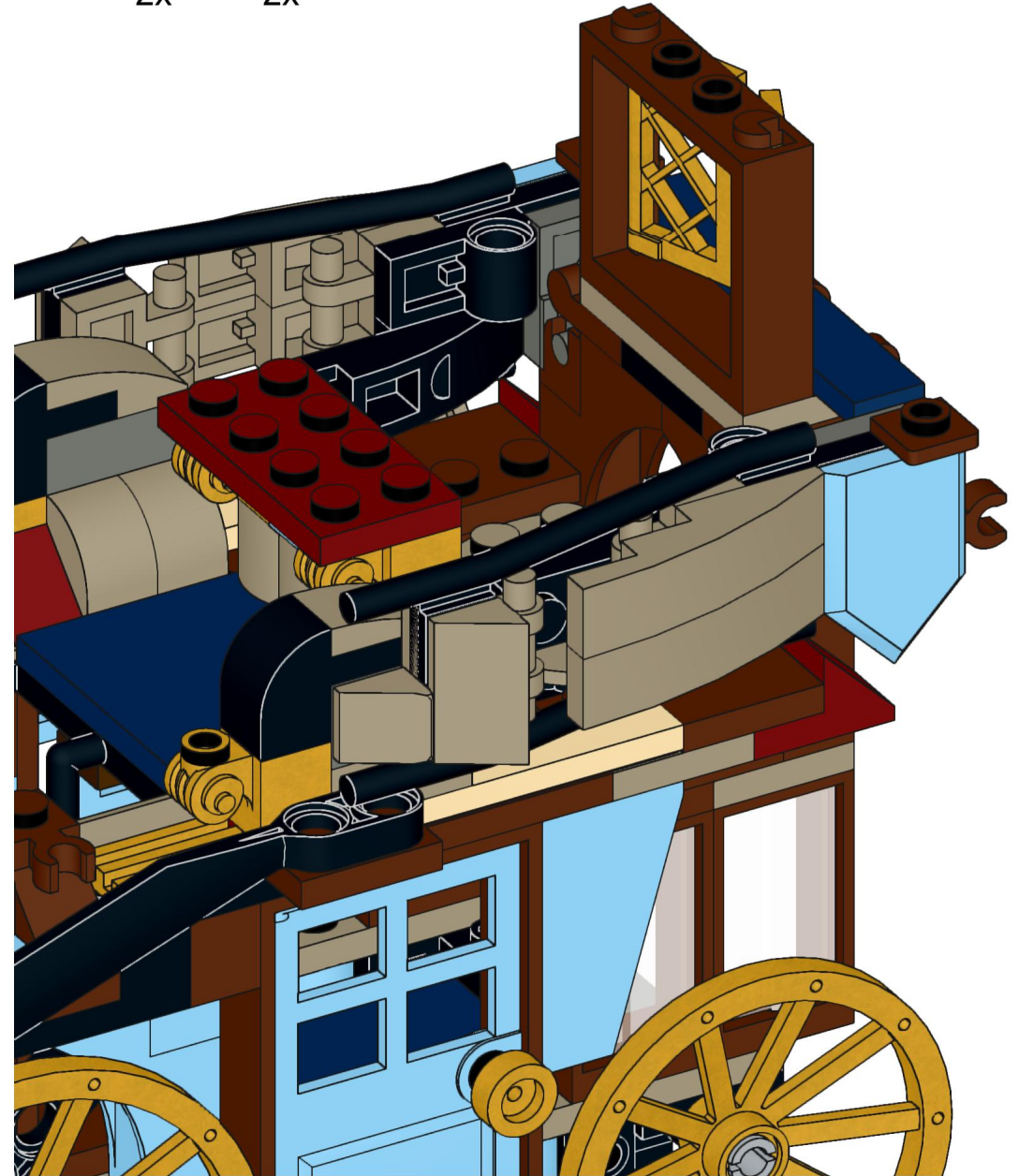

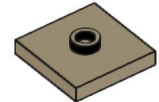

2x

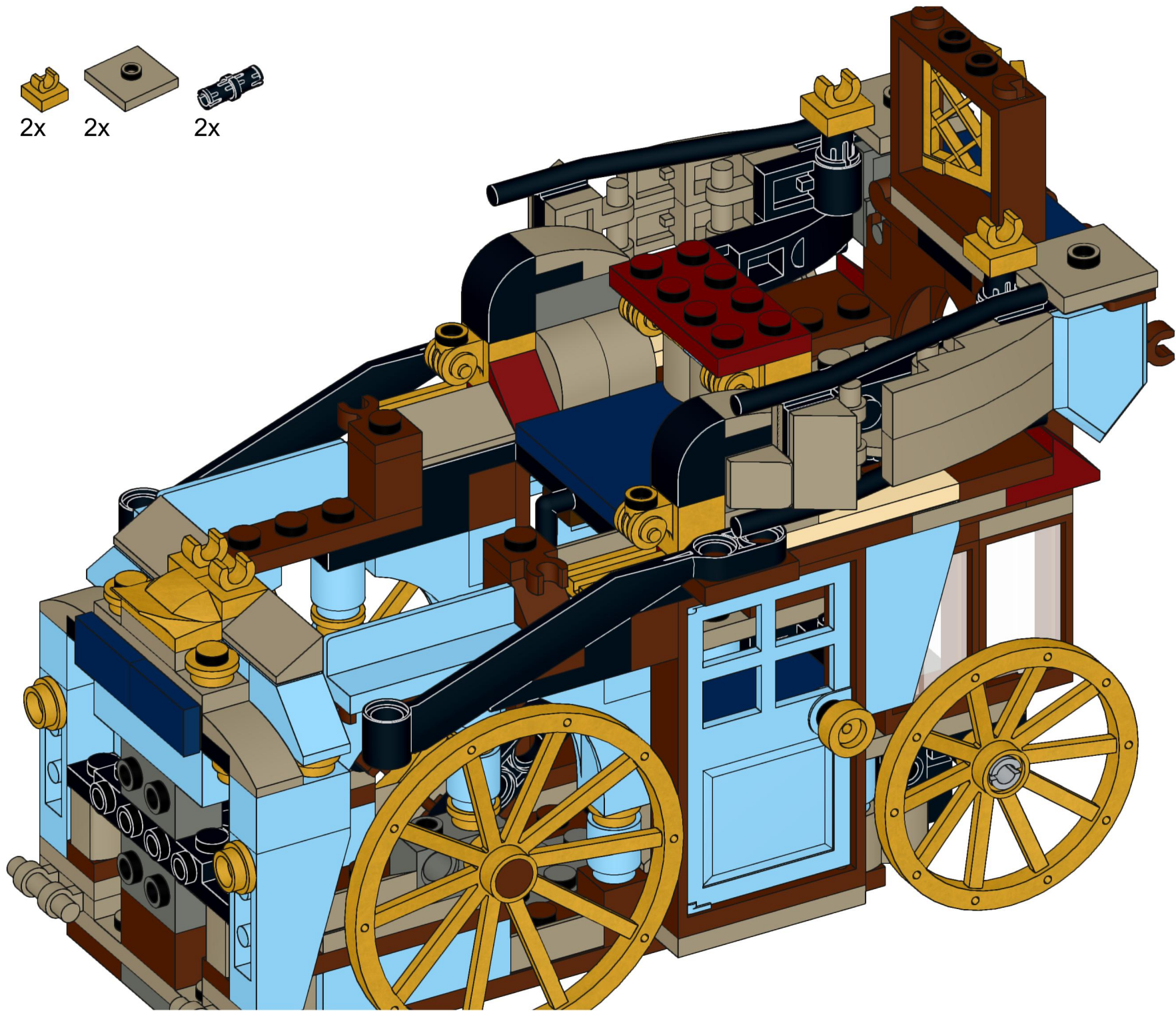



-  2x
-  2x
-  2x

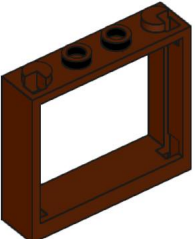

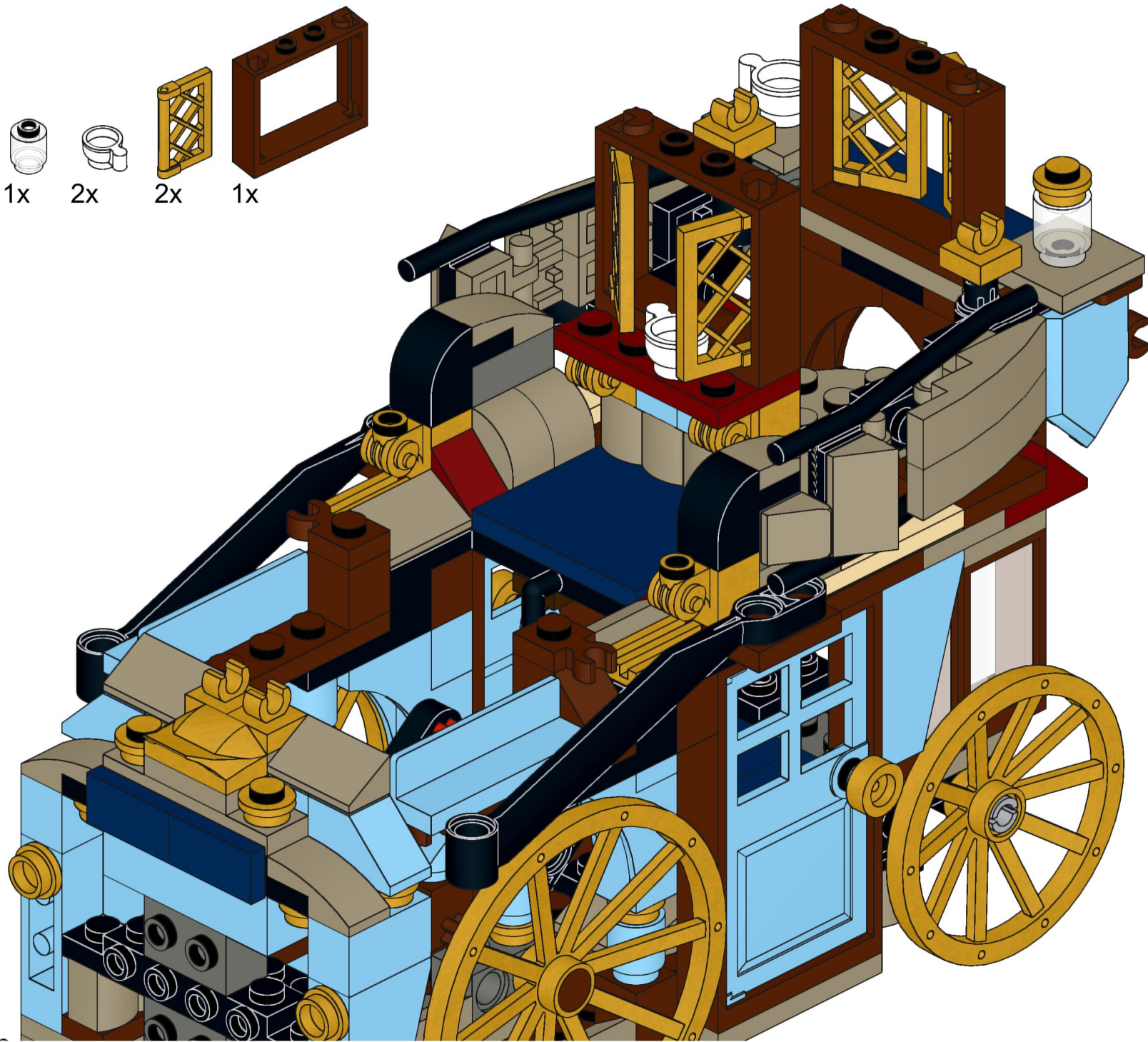

- 1x 
- 1x 
- 2x 
- 2x 
- 1x 

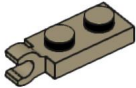

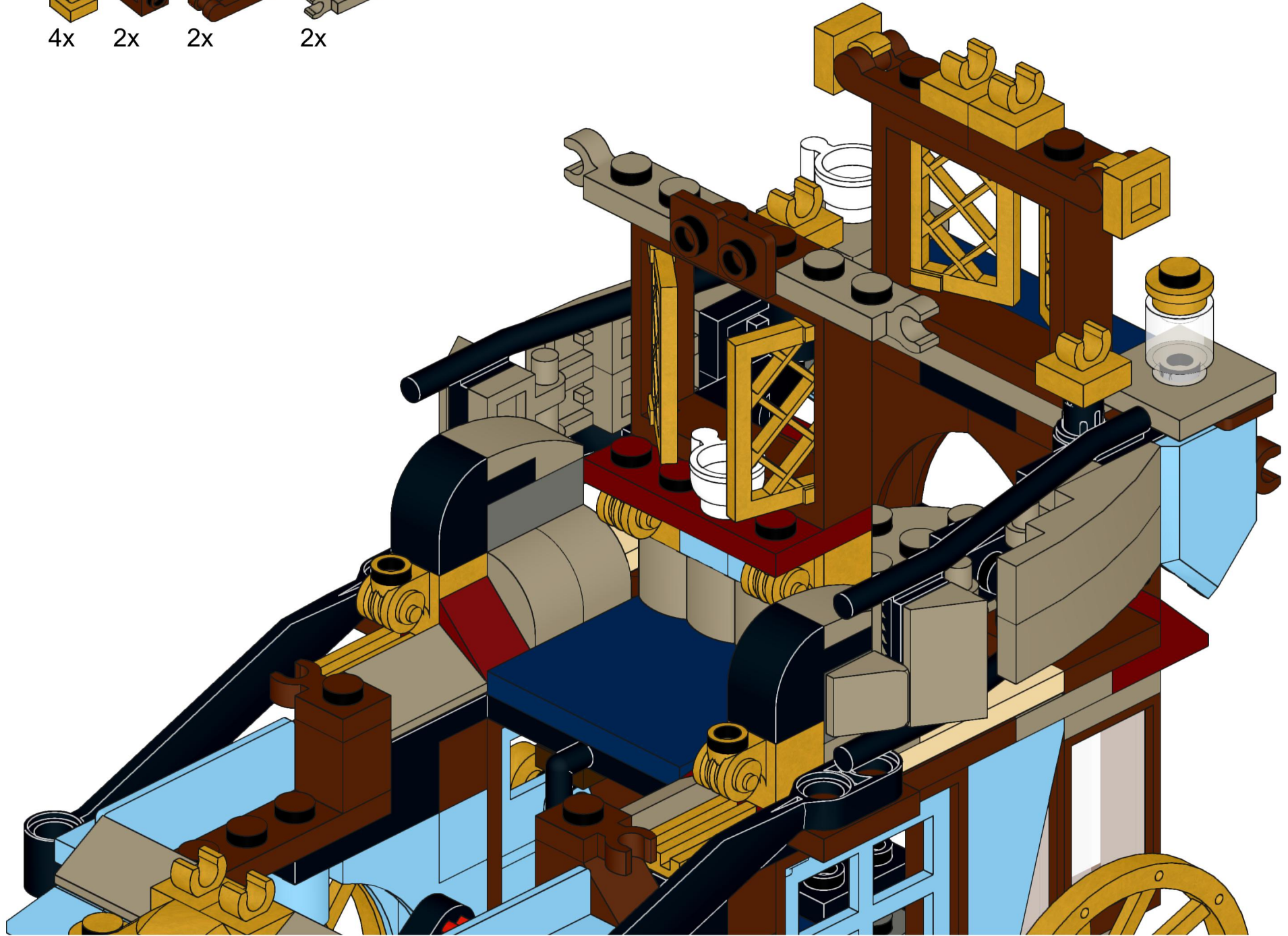

- 4x 
- 2x 
- 2x 
- 2x 

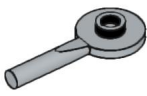

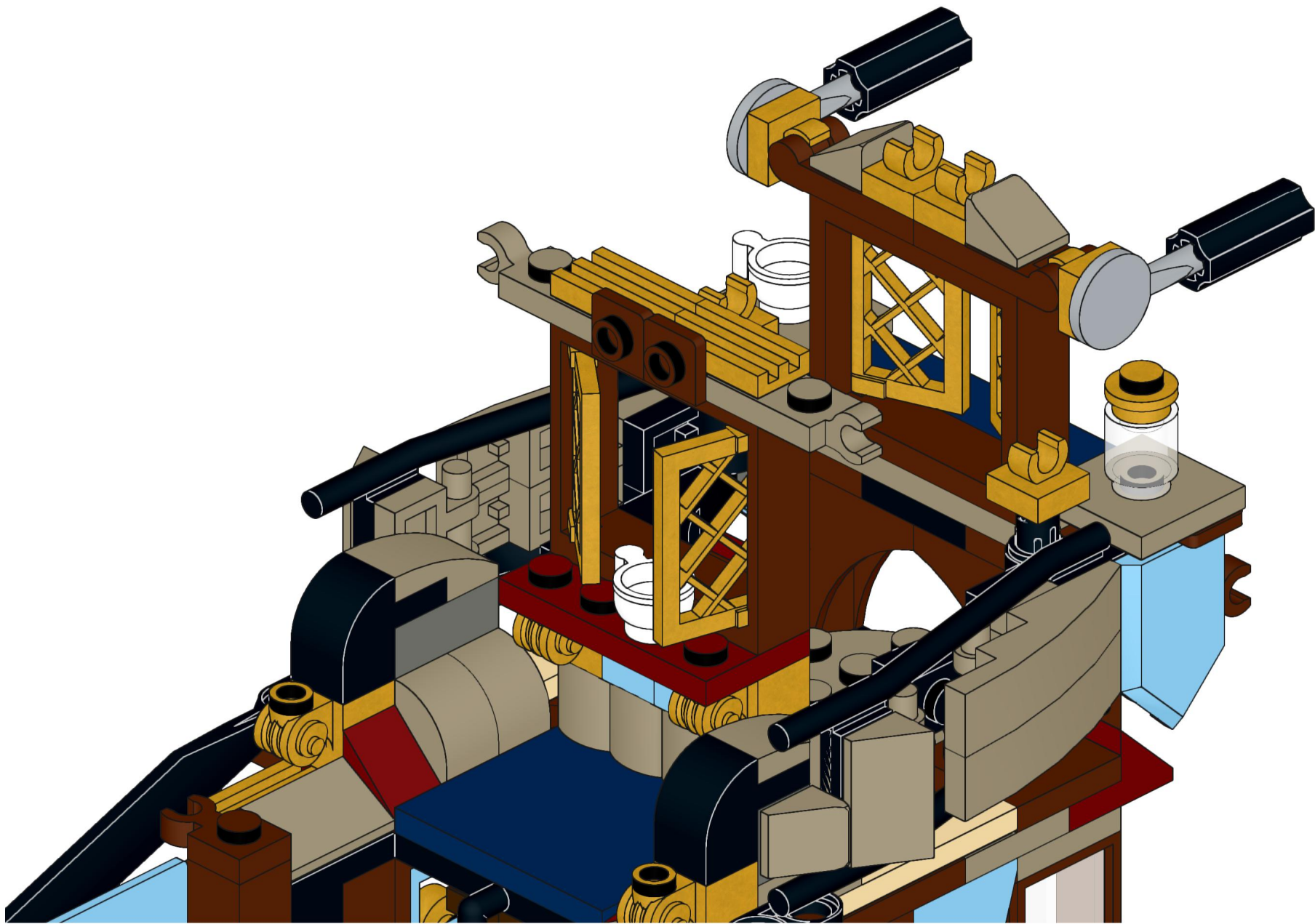
- 2x 
- 2x 
- 2x 
- 2x 



-  2x
-  1x
-  2x

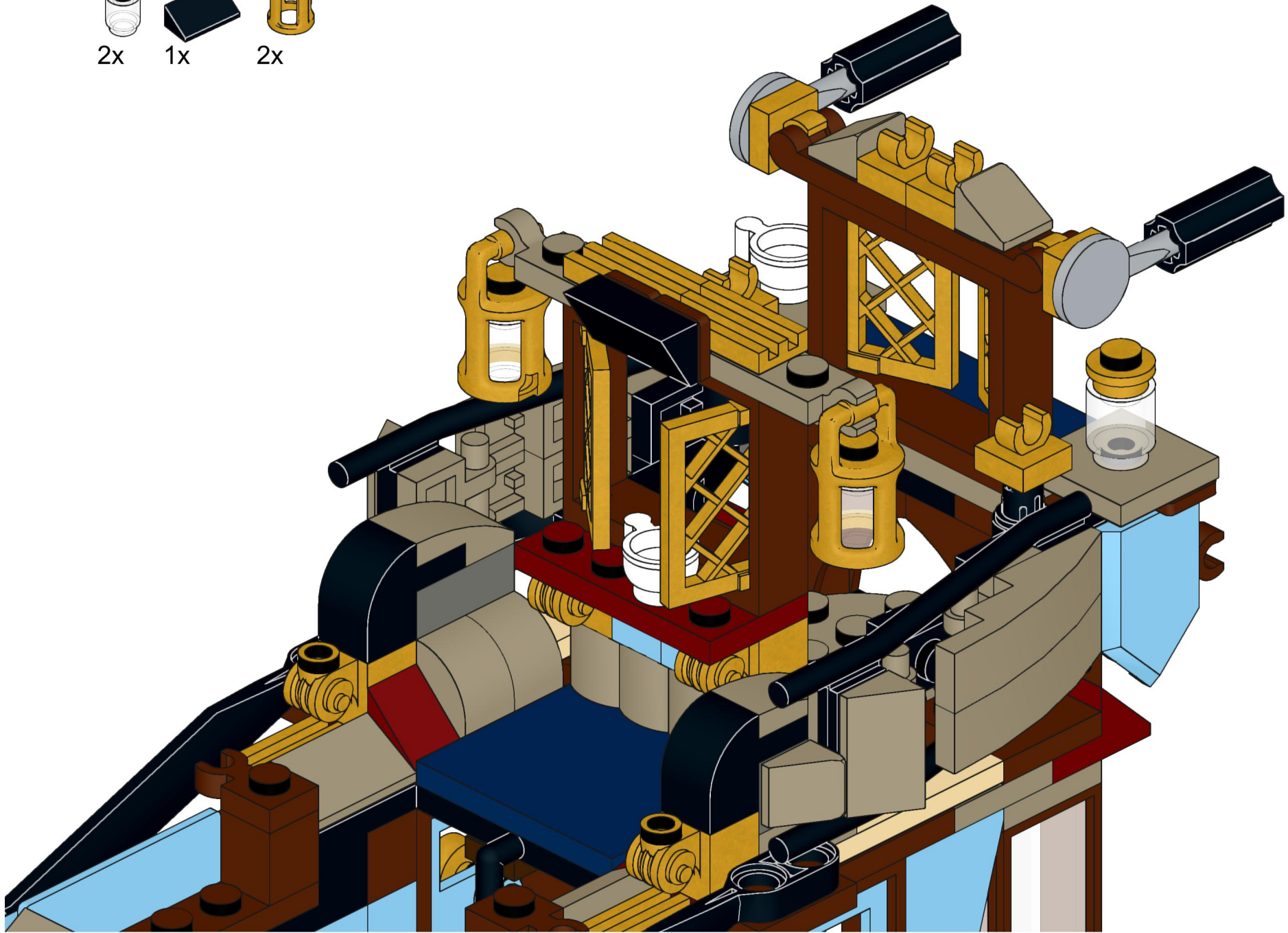

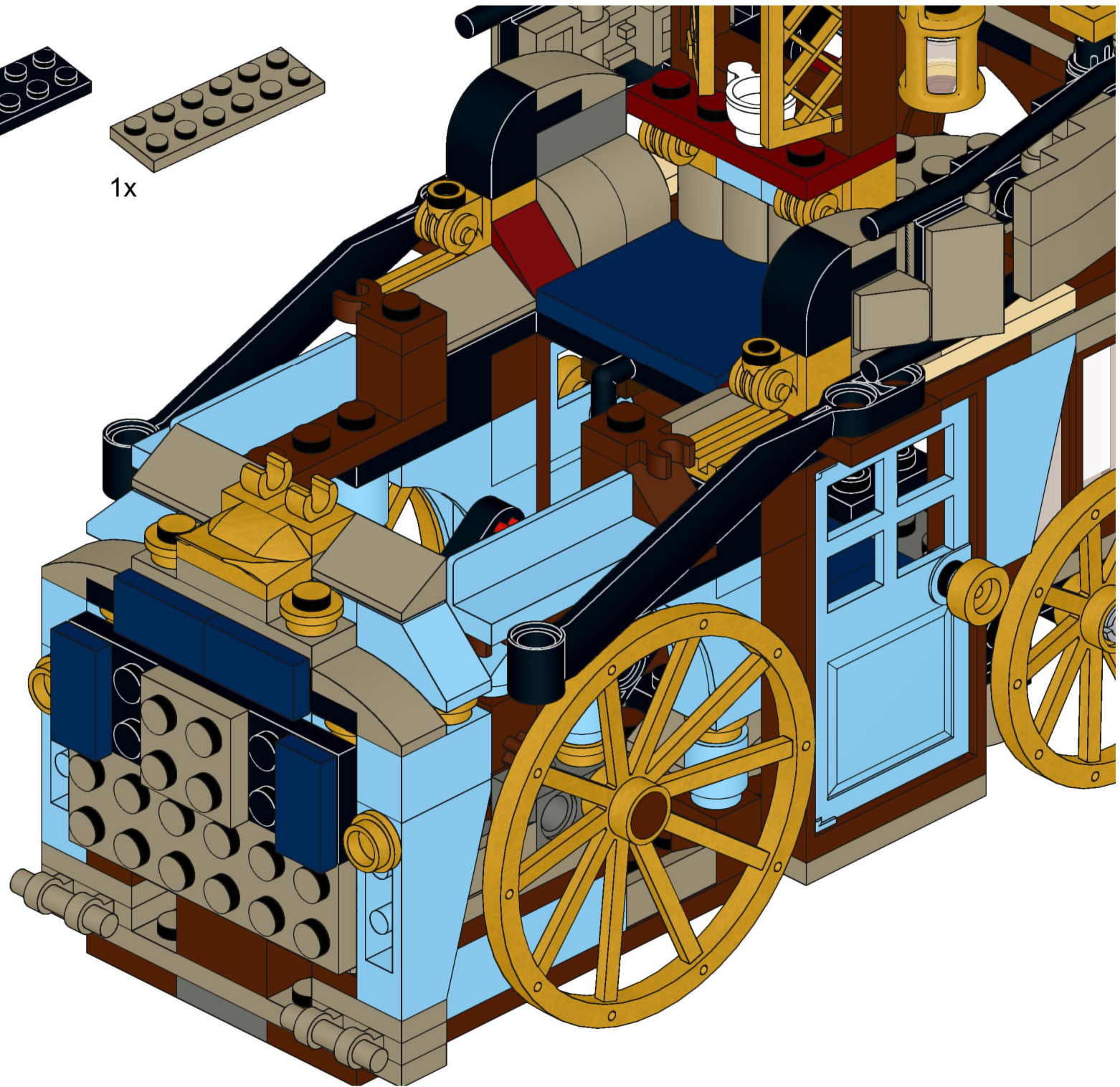

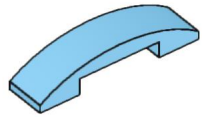

1x

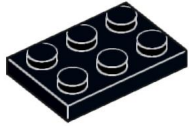



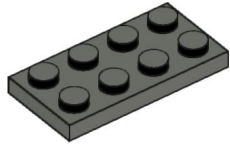

2x

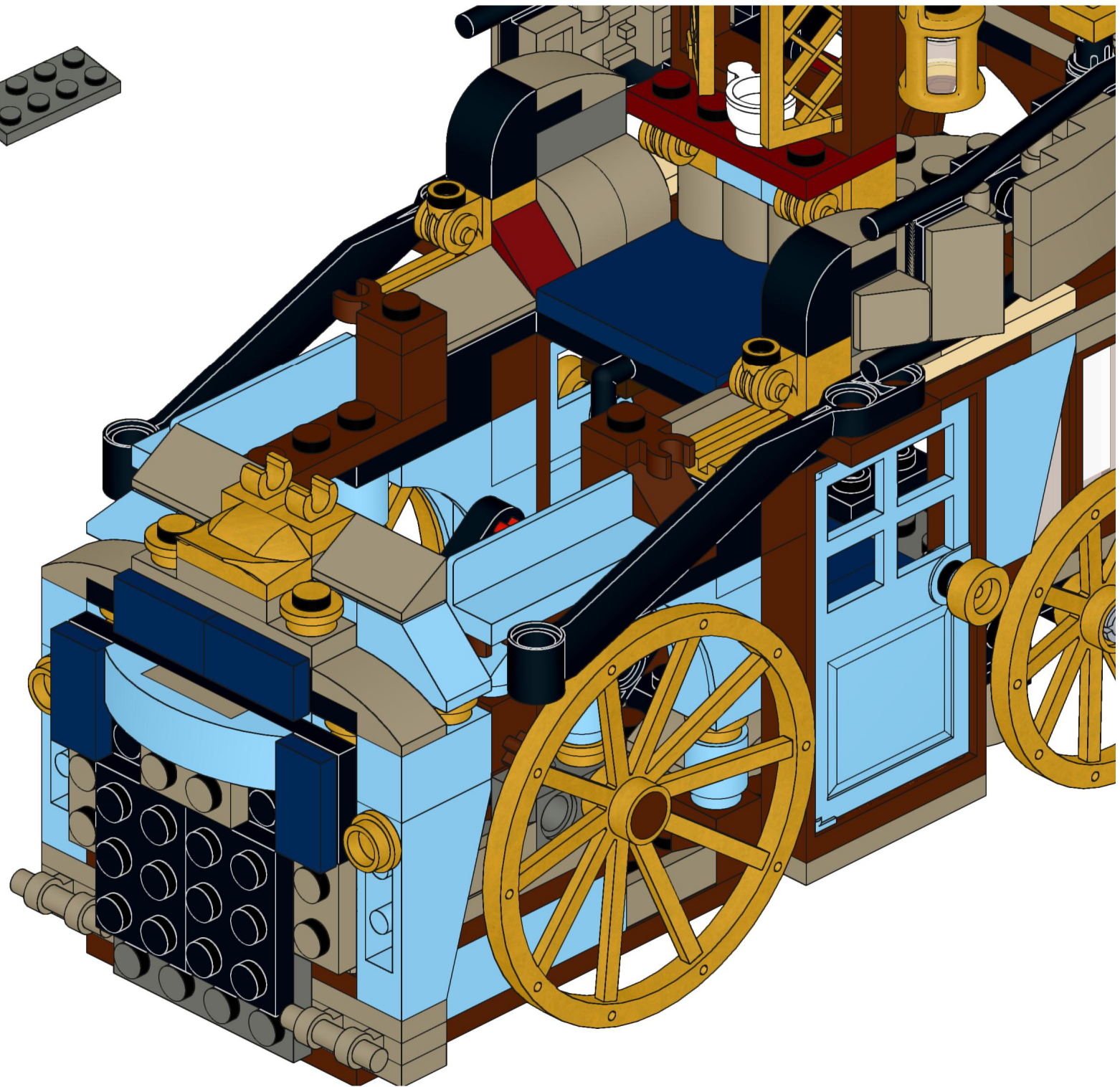

1x



- 1x 
- 2x 
- 2x 
- 1x 
- 1x 

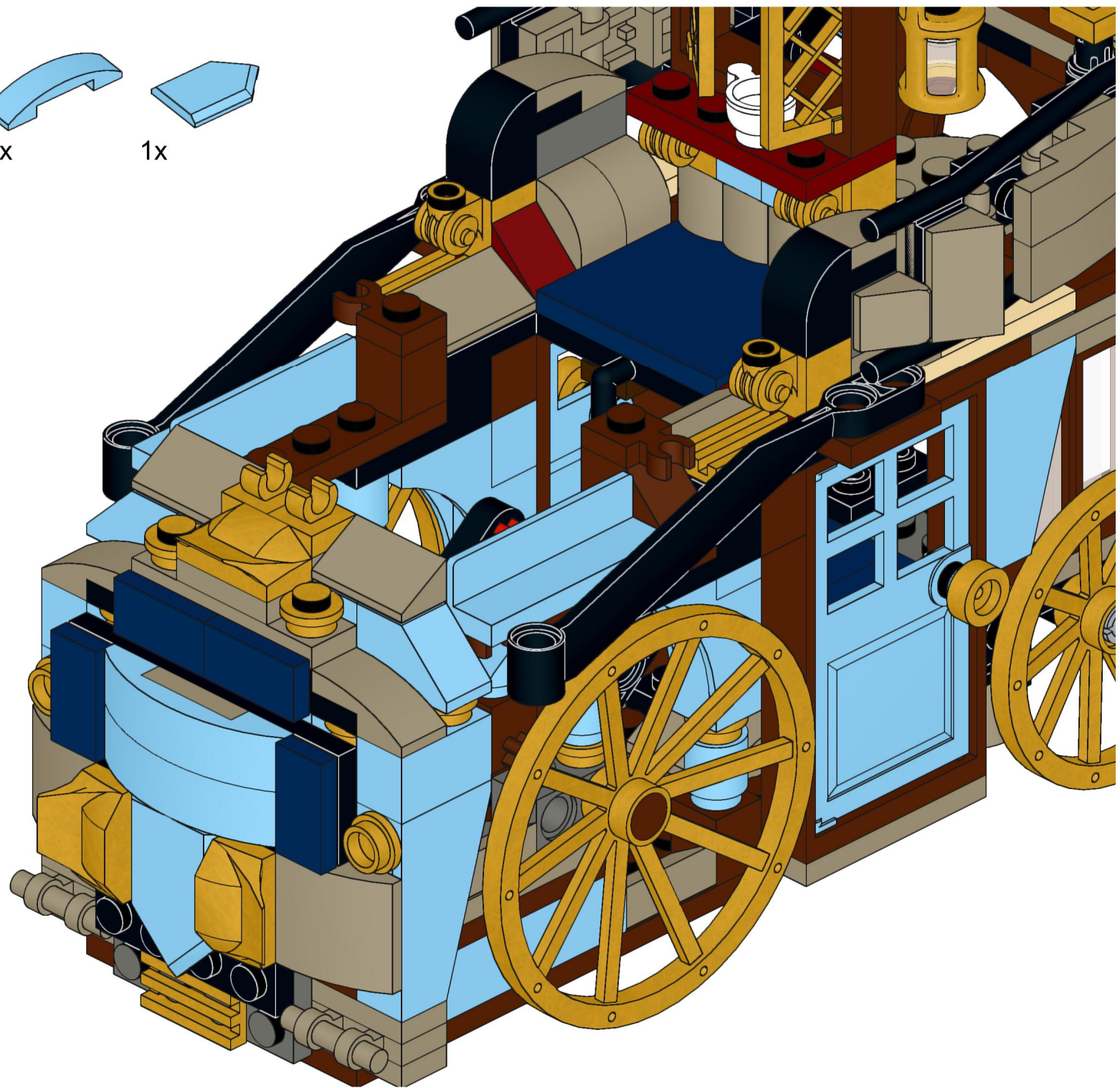

50

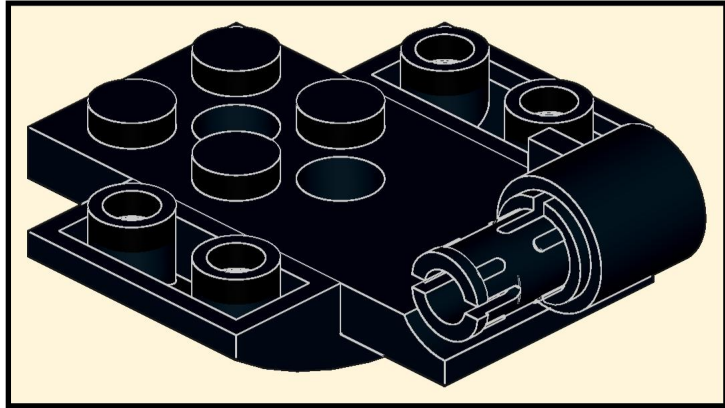

1x

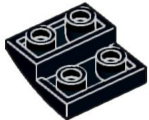

2x

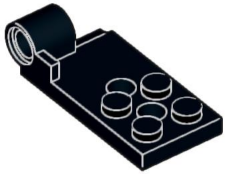

1x

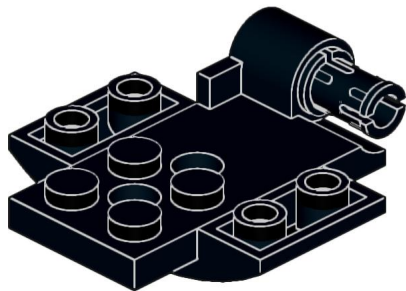

51

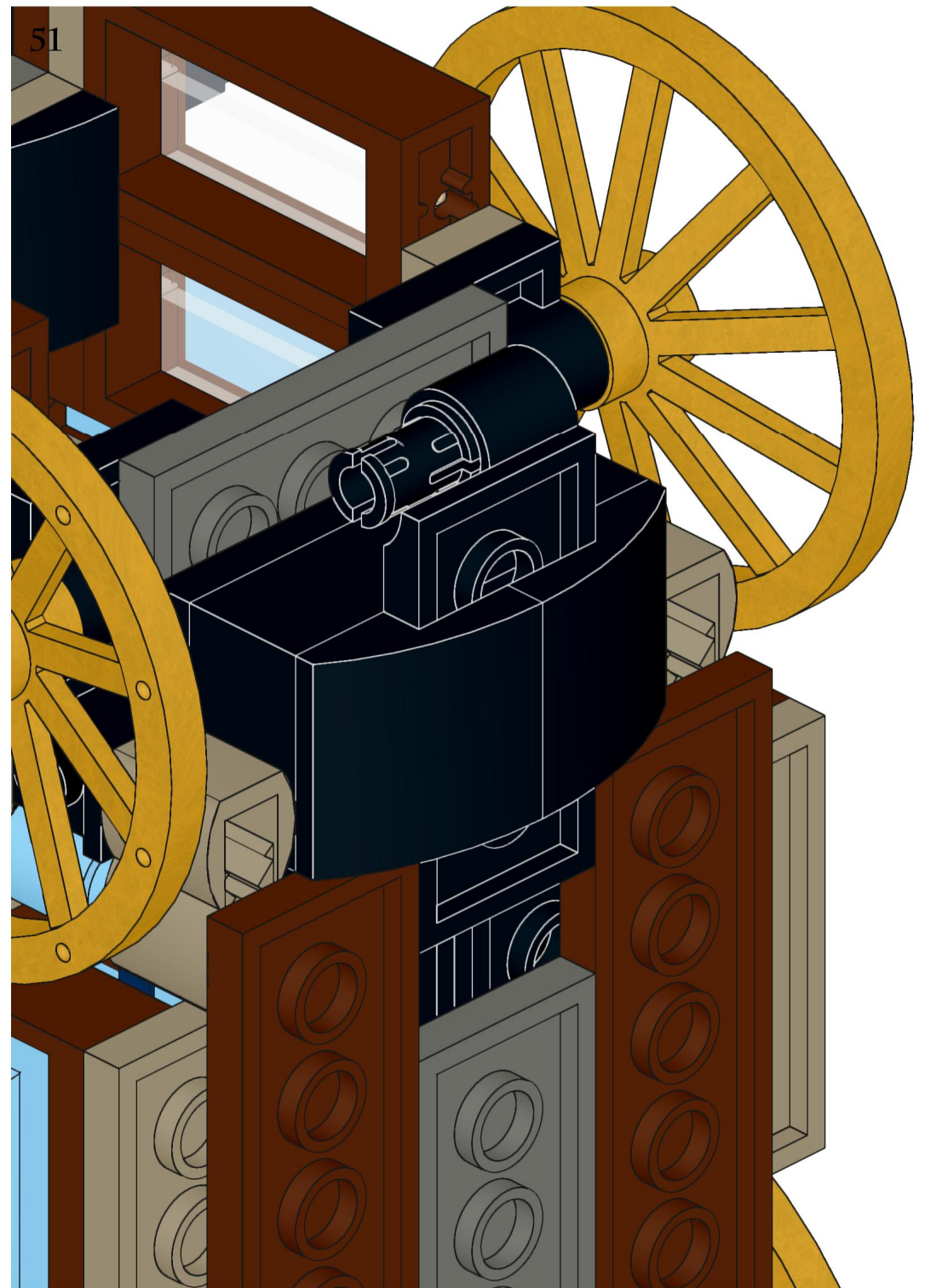

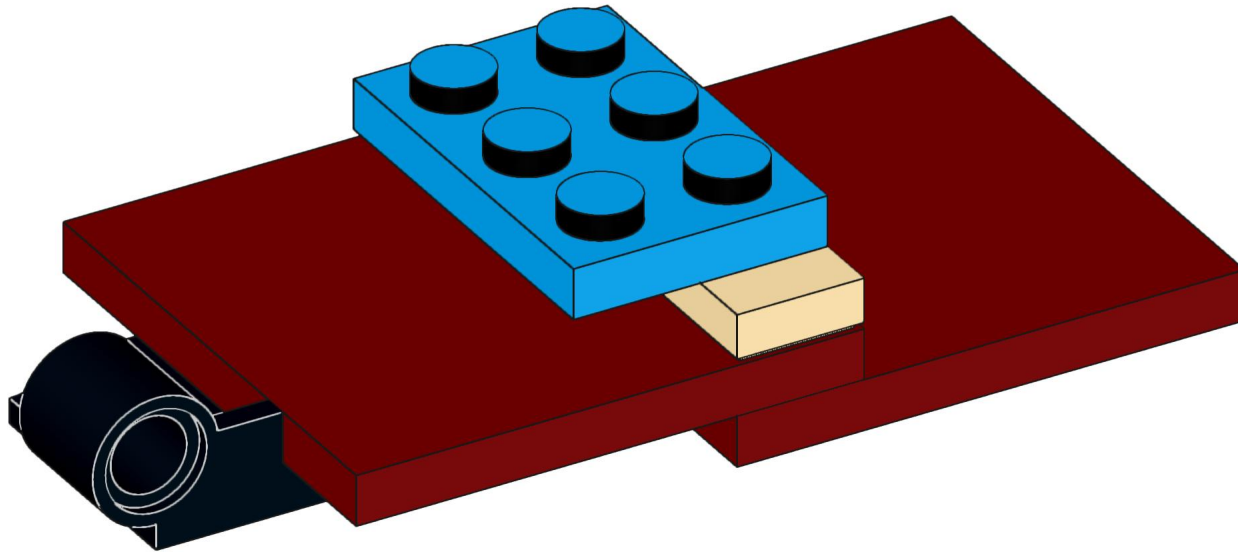
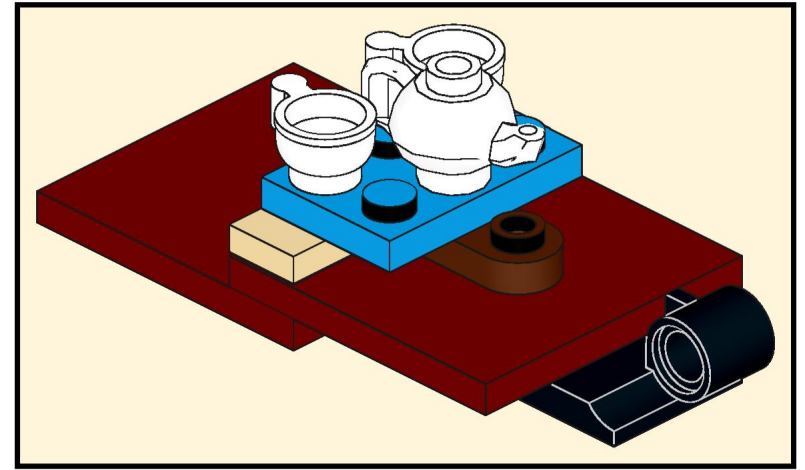
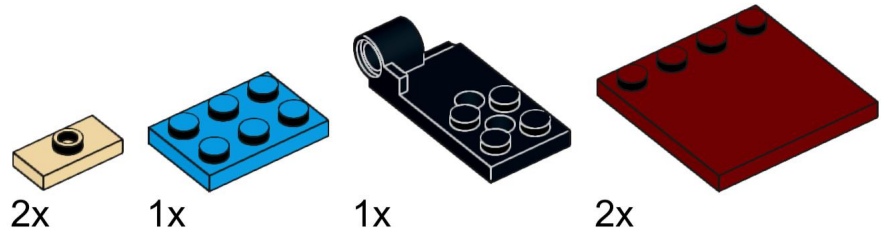

53

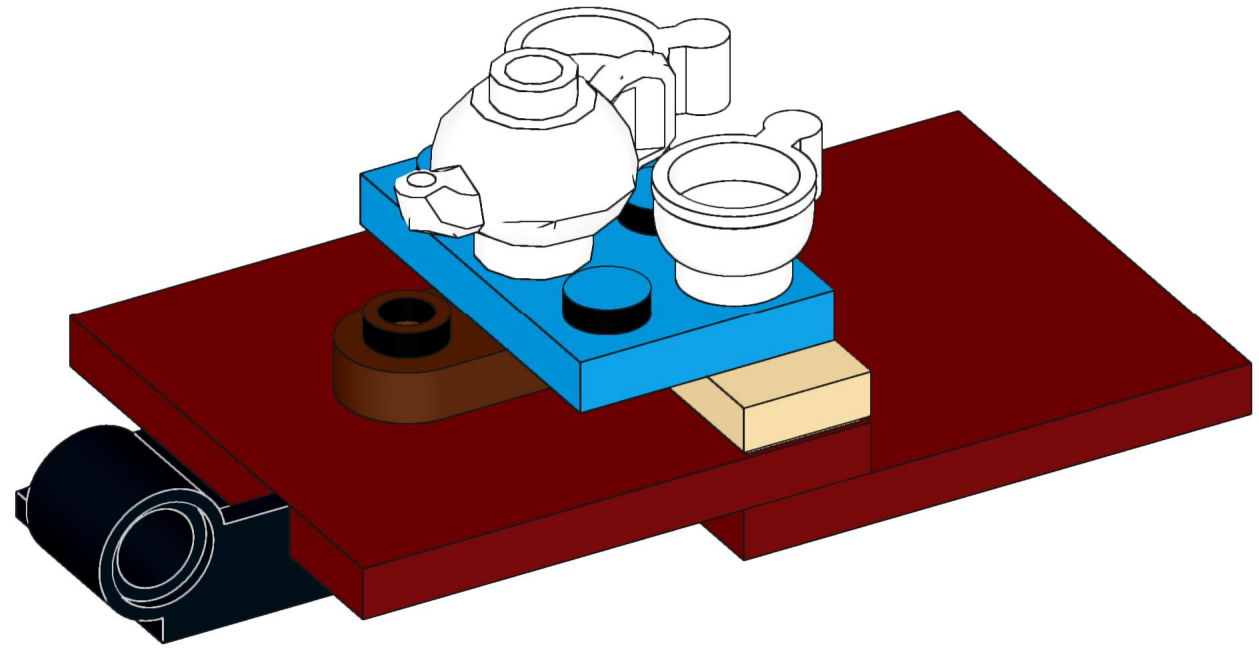

54

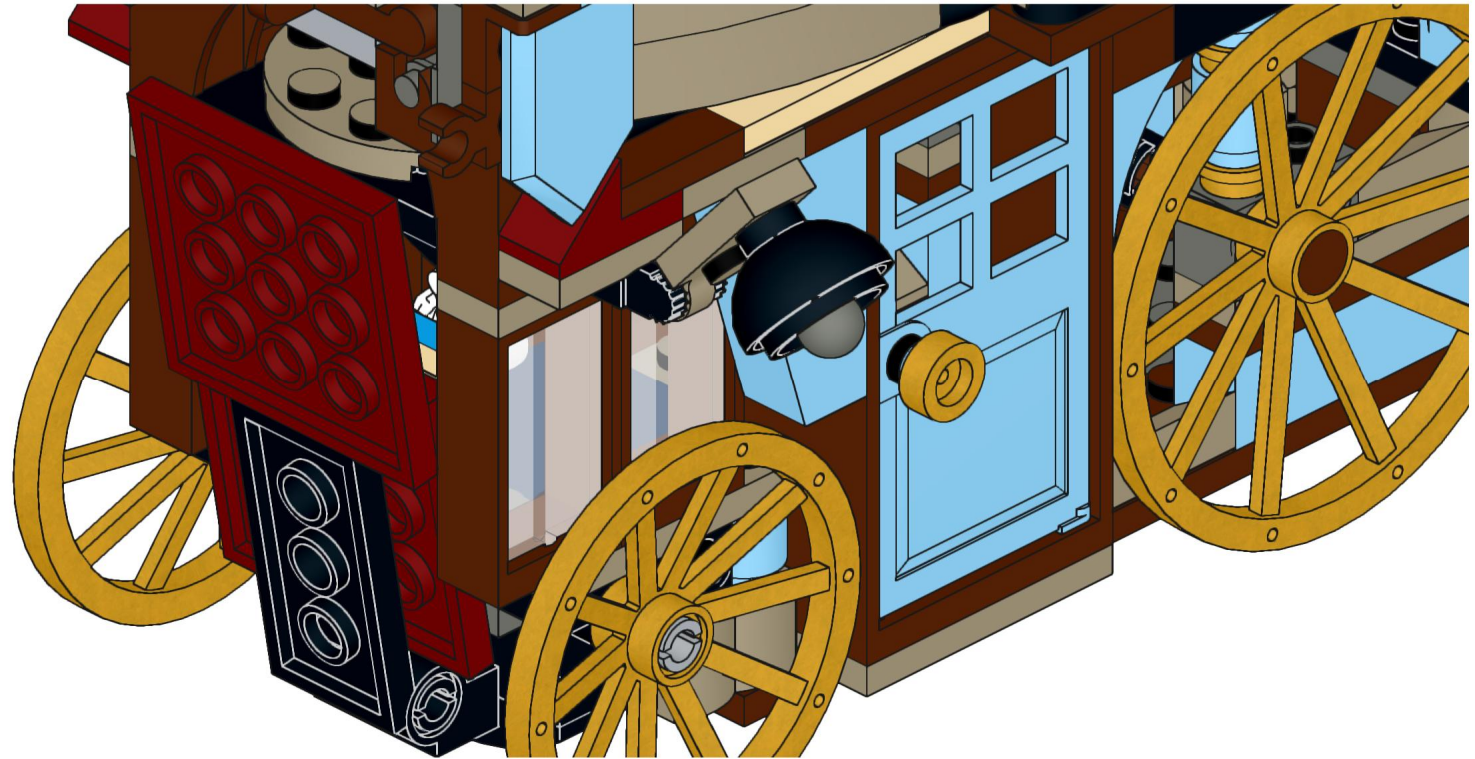

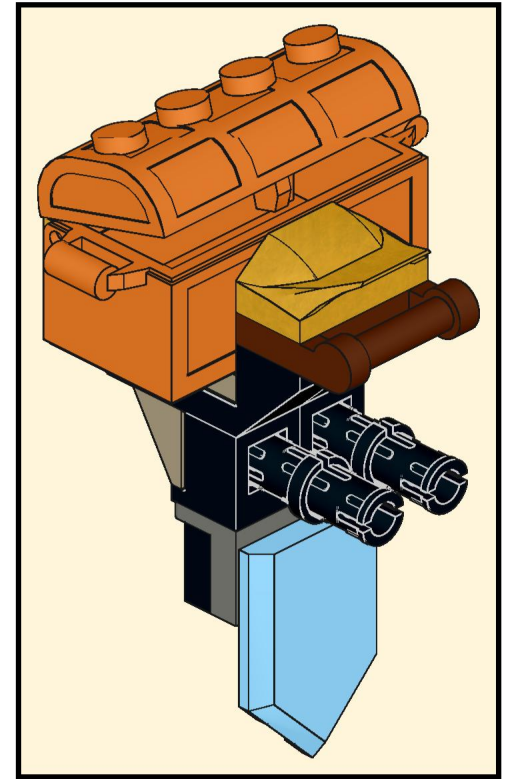
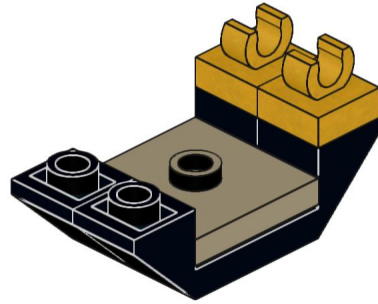
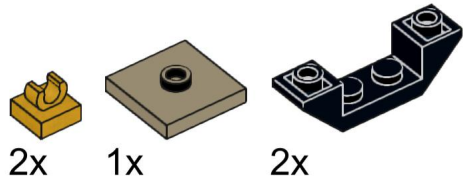

56

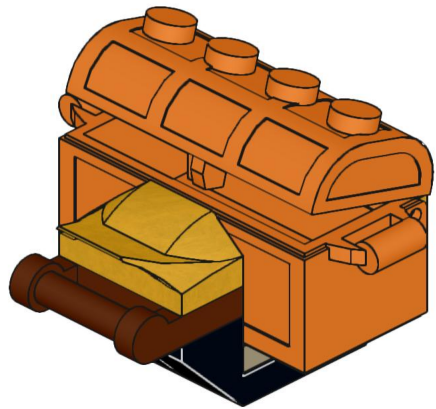
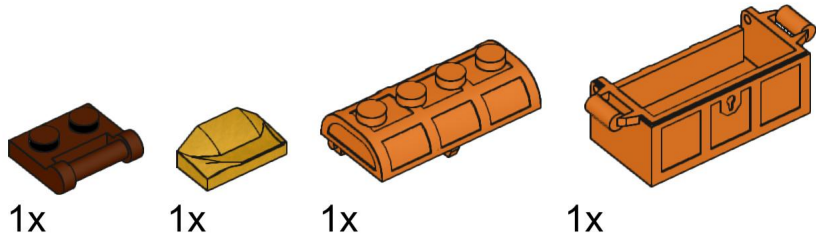

57

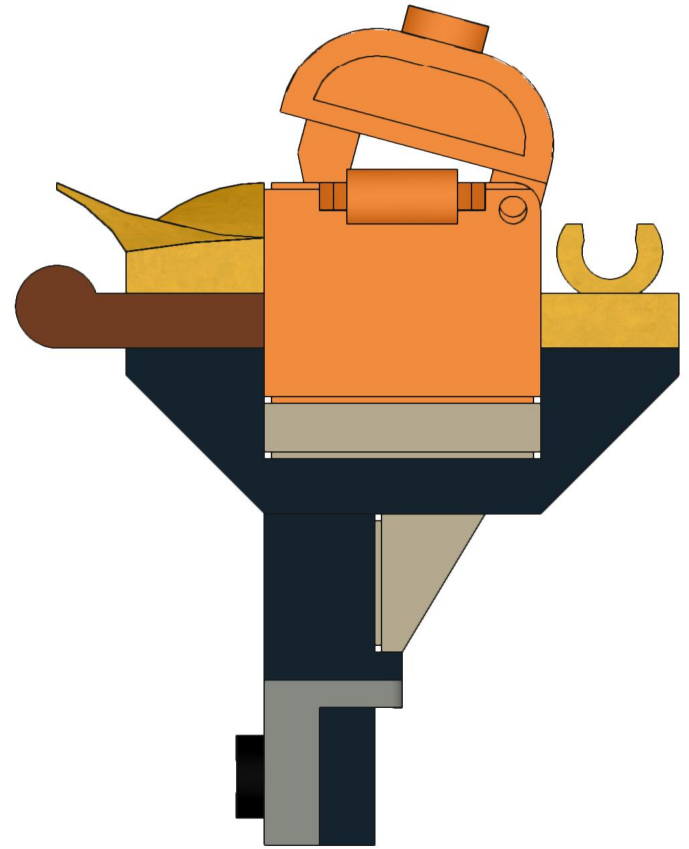
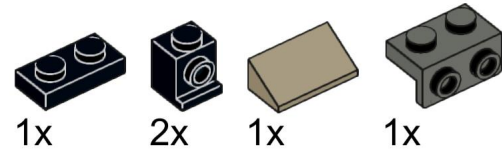

58

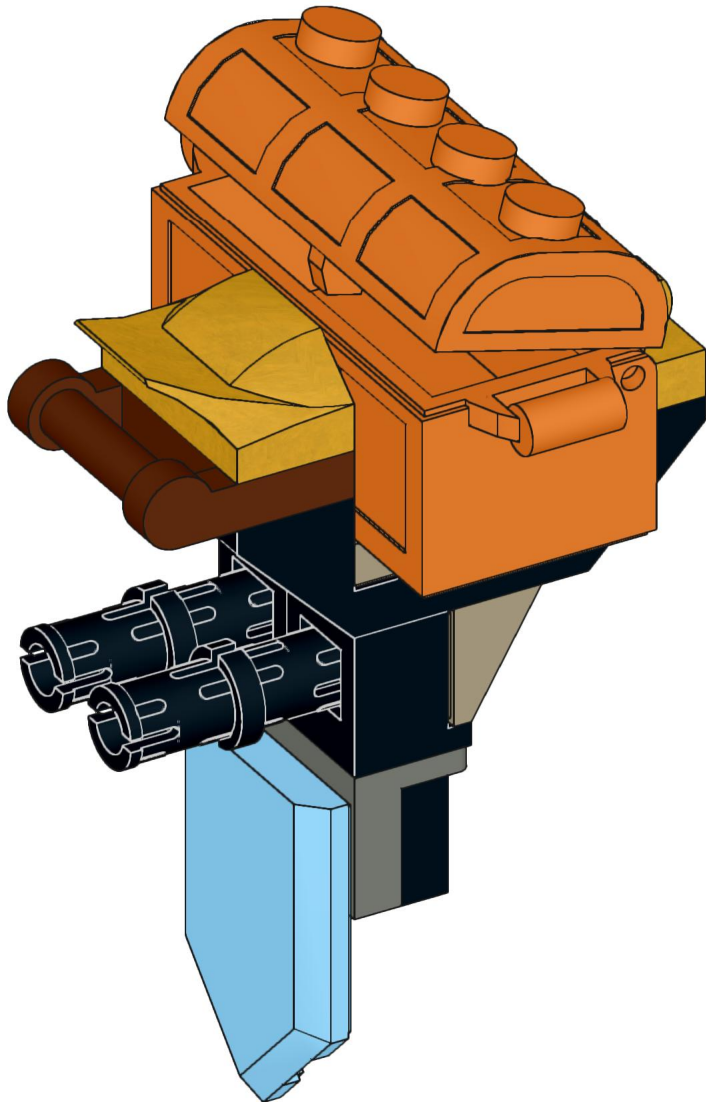
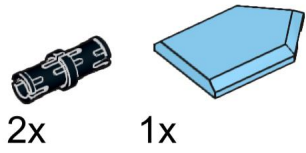

59

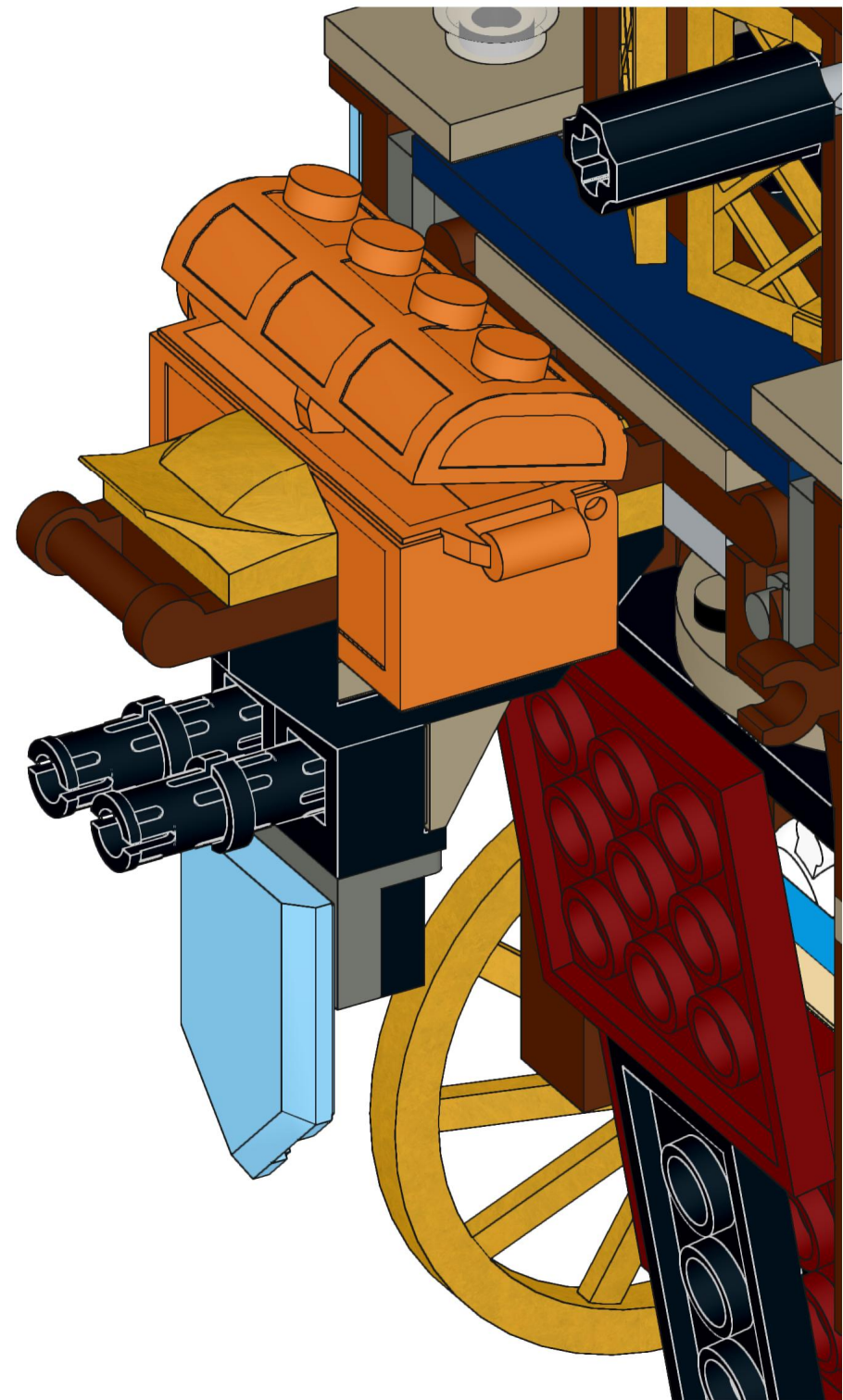

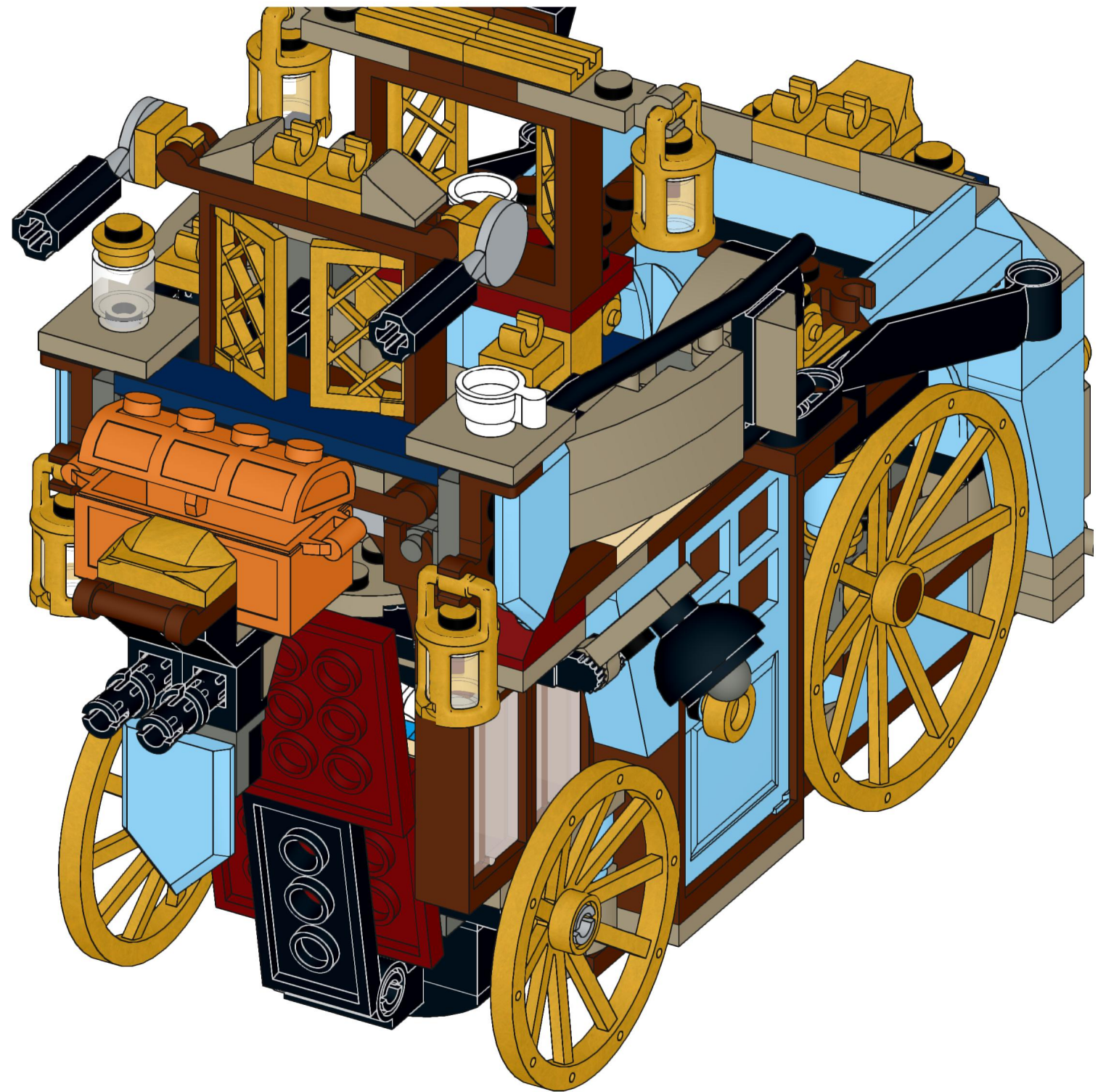
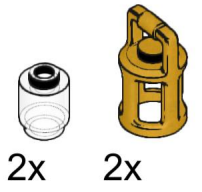

61

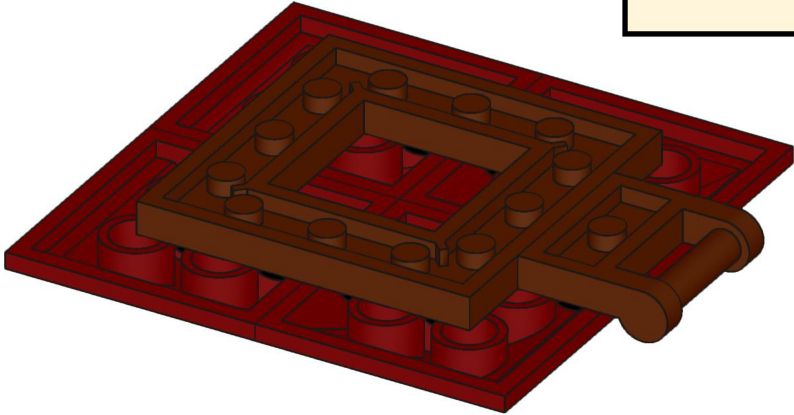
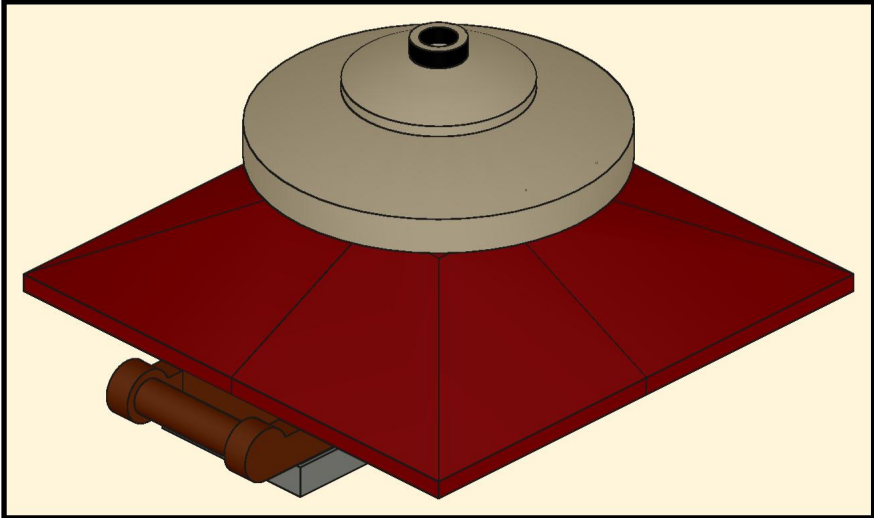
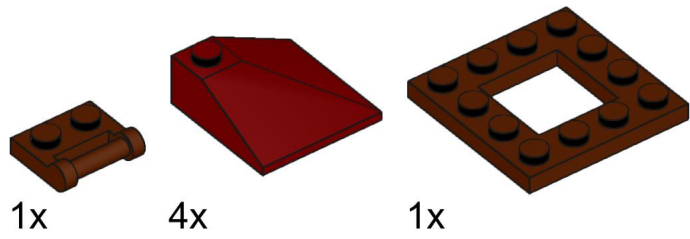

62



1x



1x

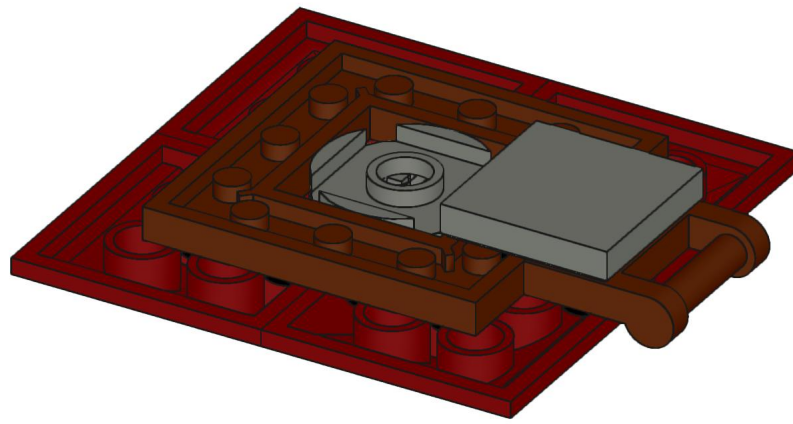

63

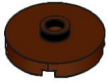

1x

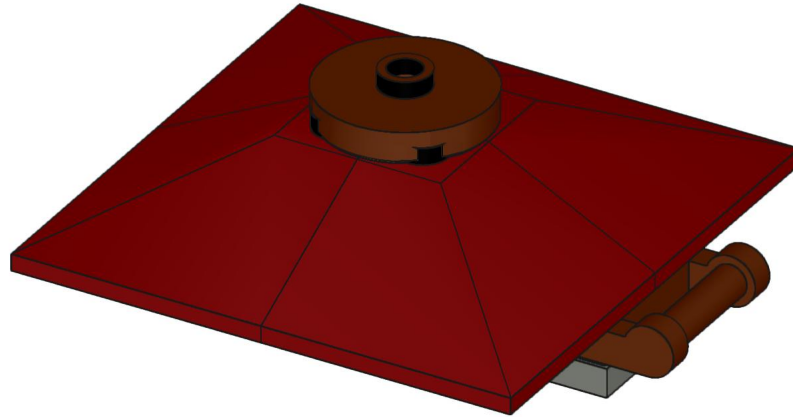

64



1x

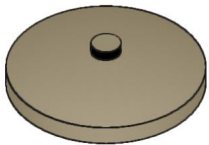

1x

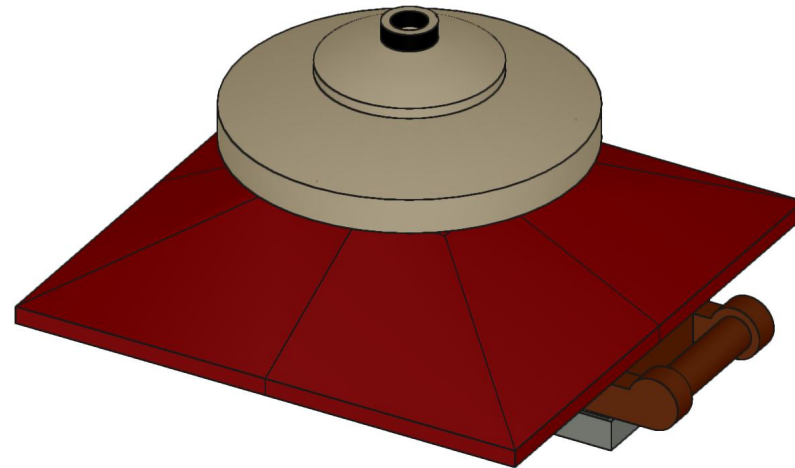

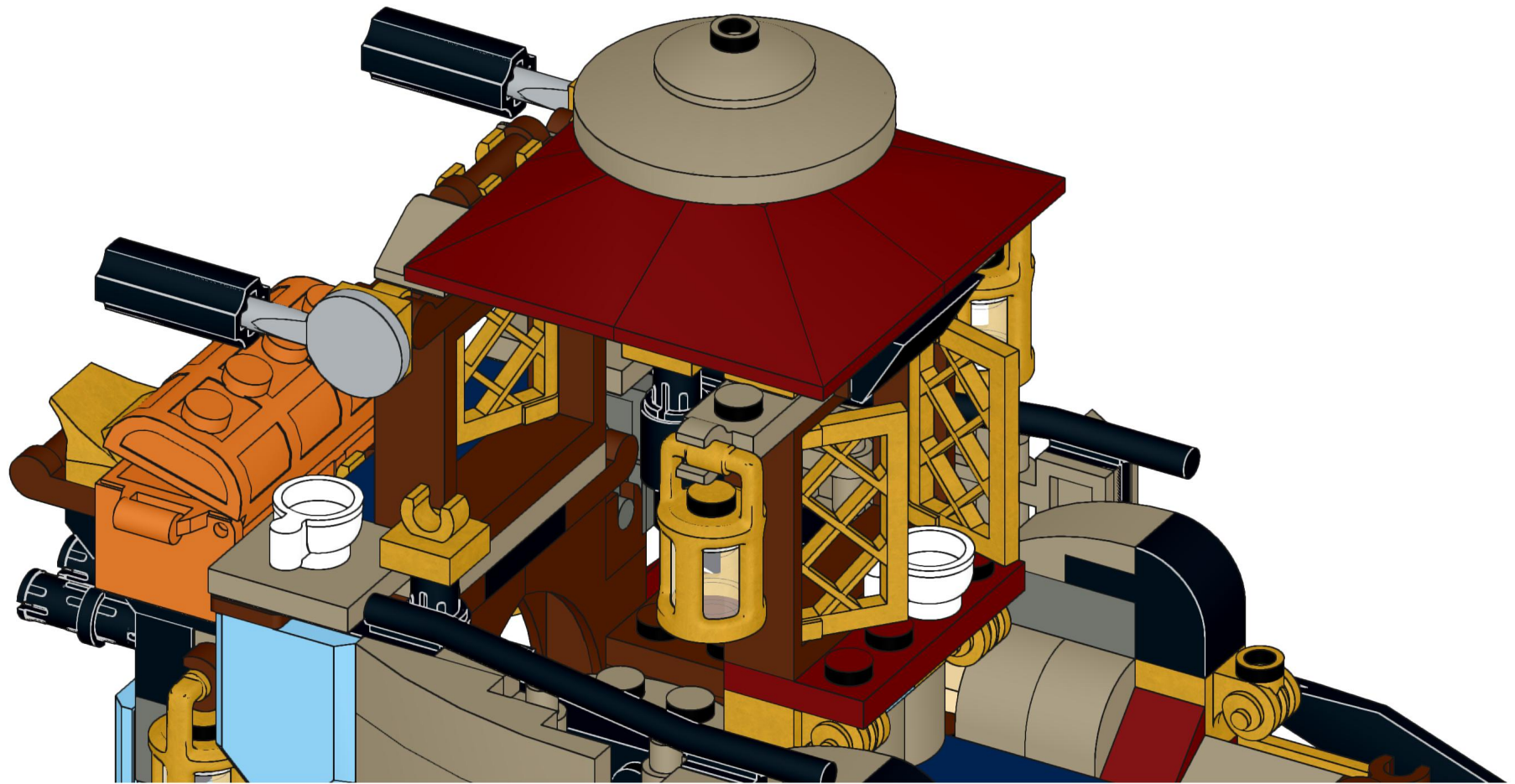

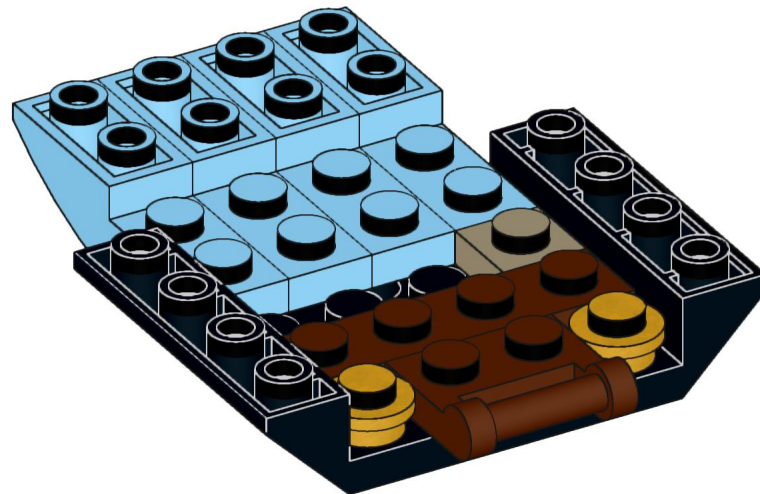
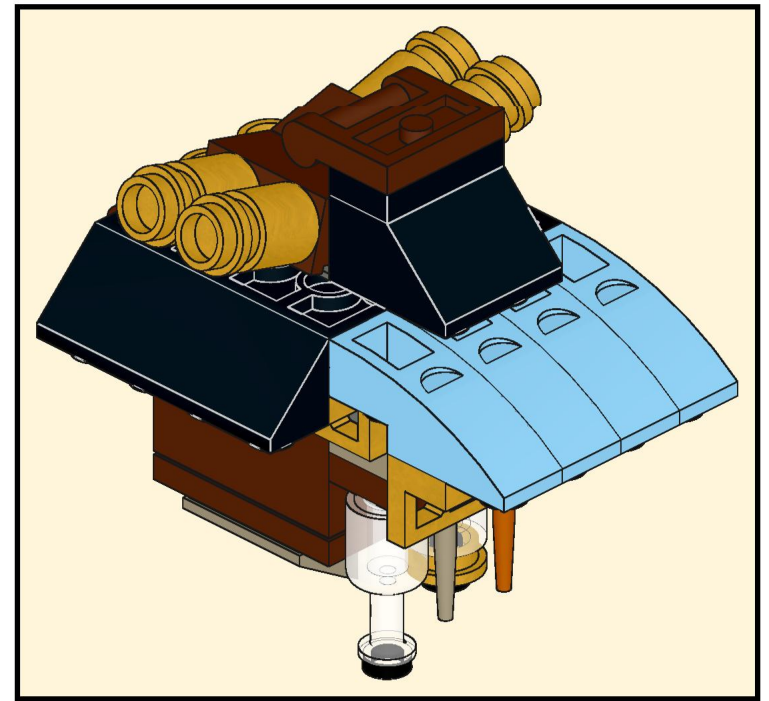
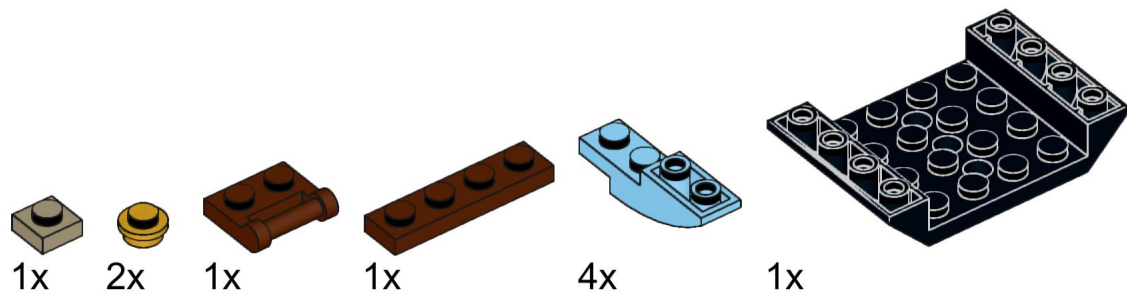

67

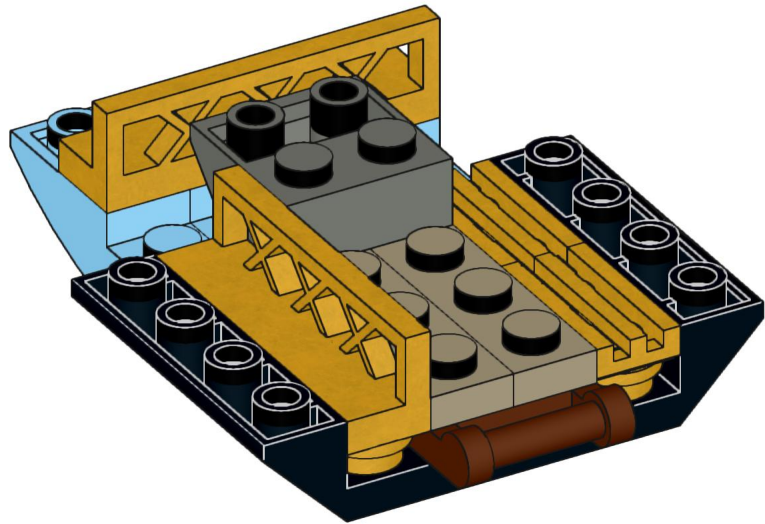
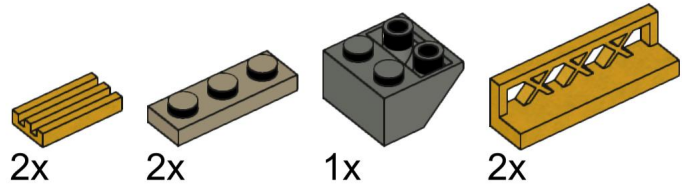

68

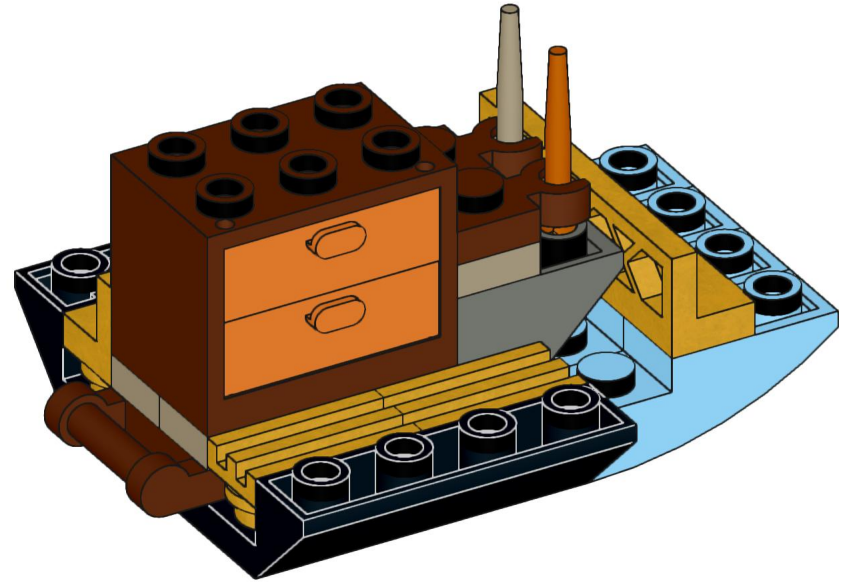
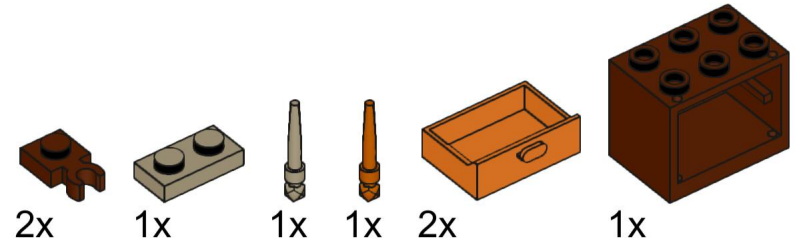

69

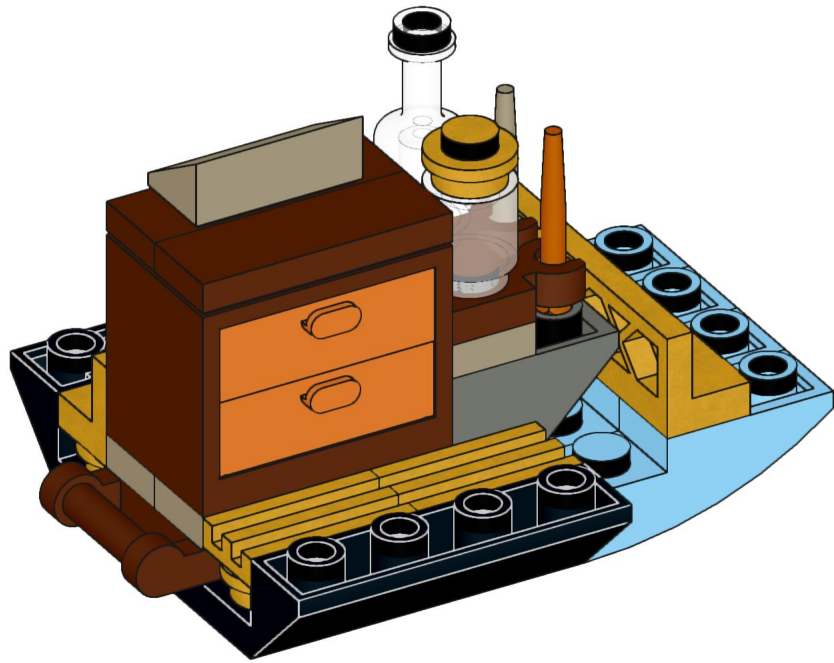
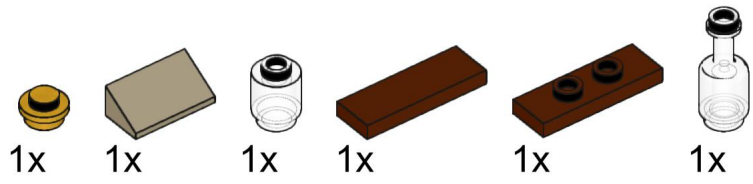

70

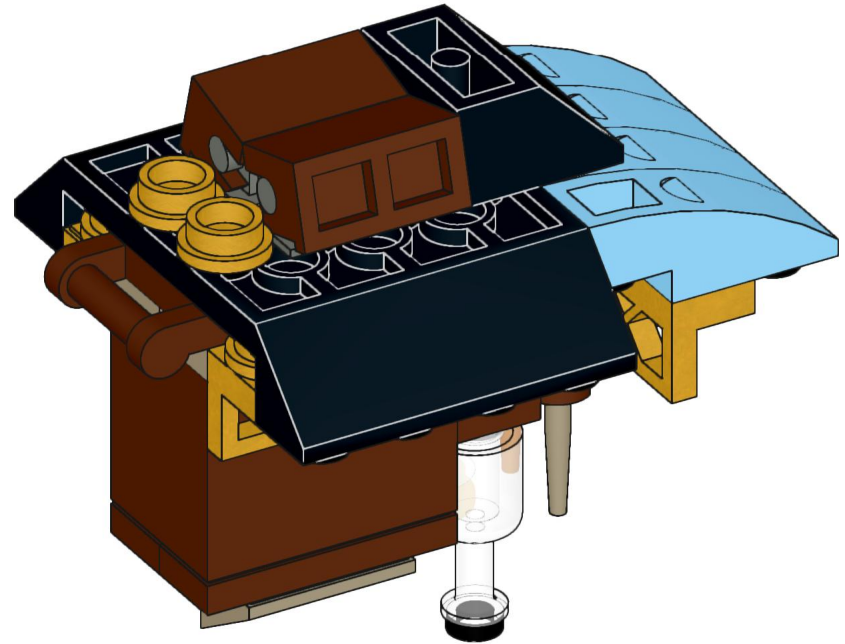
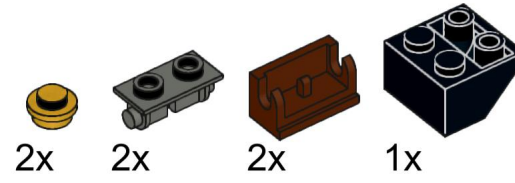

71

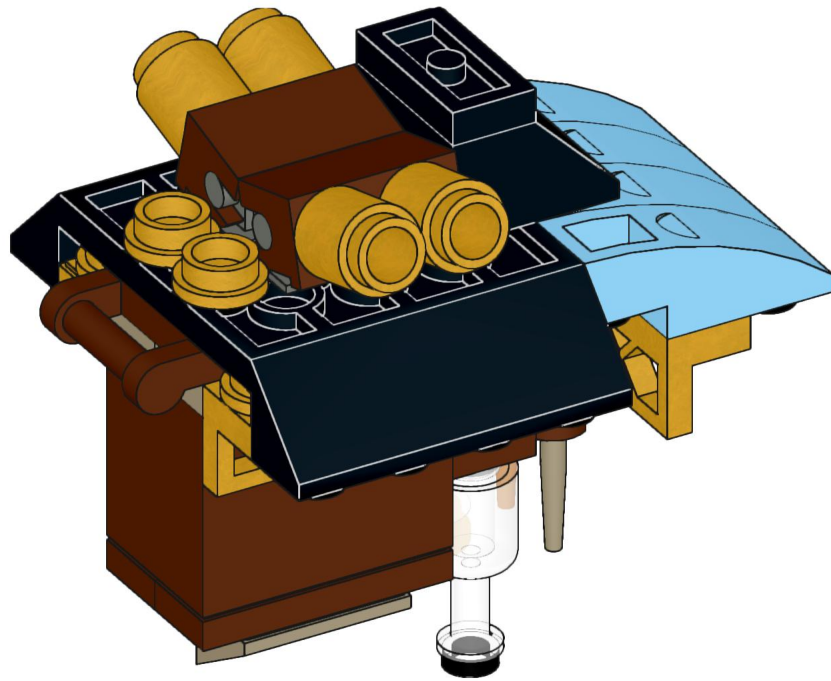
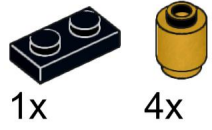

72

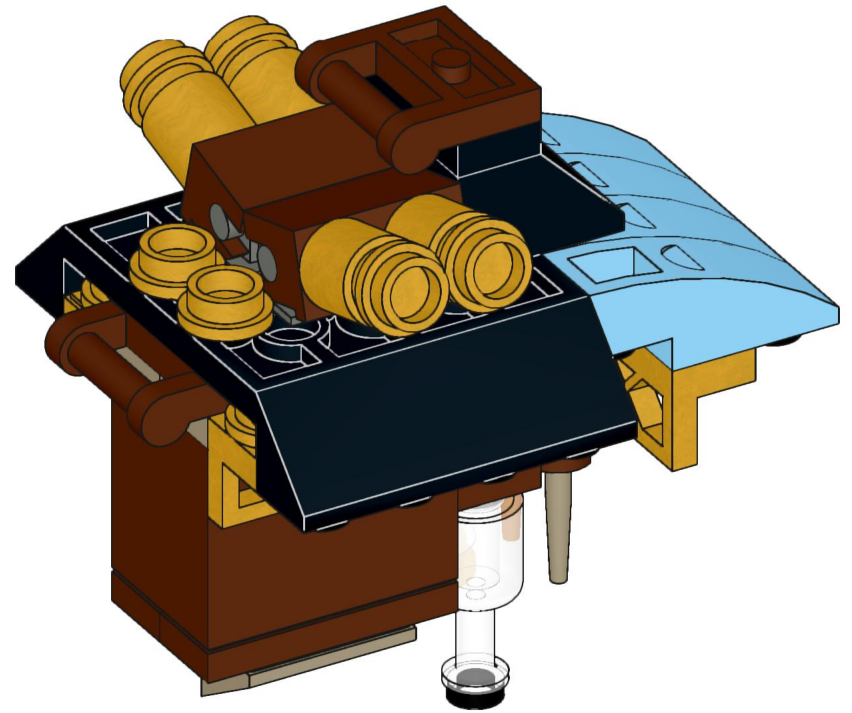
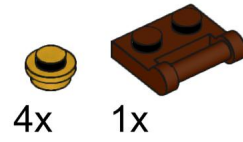

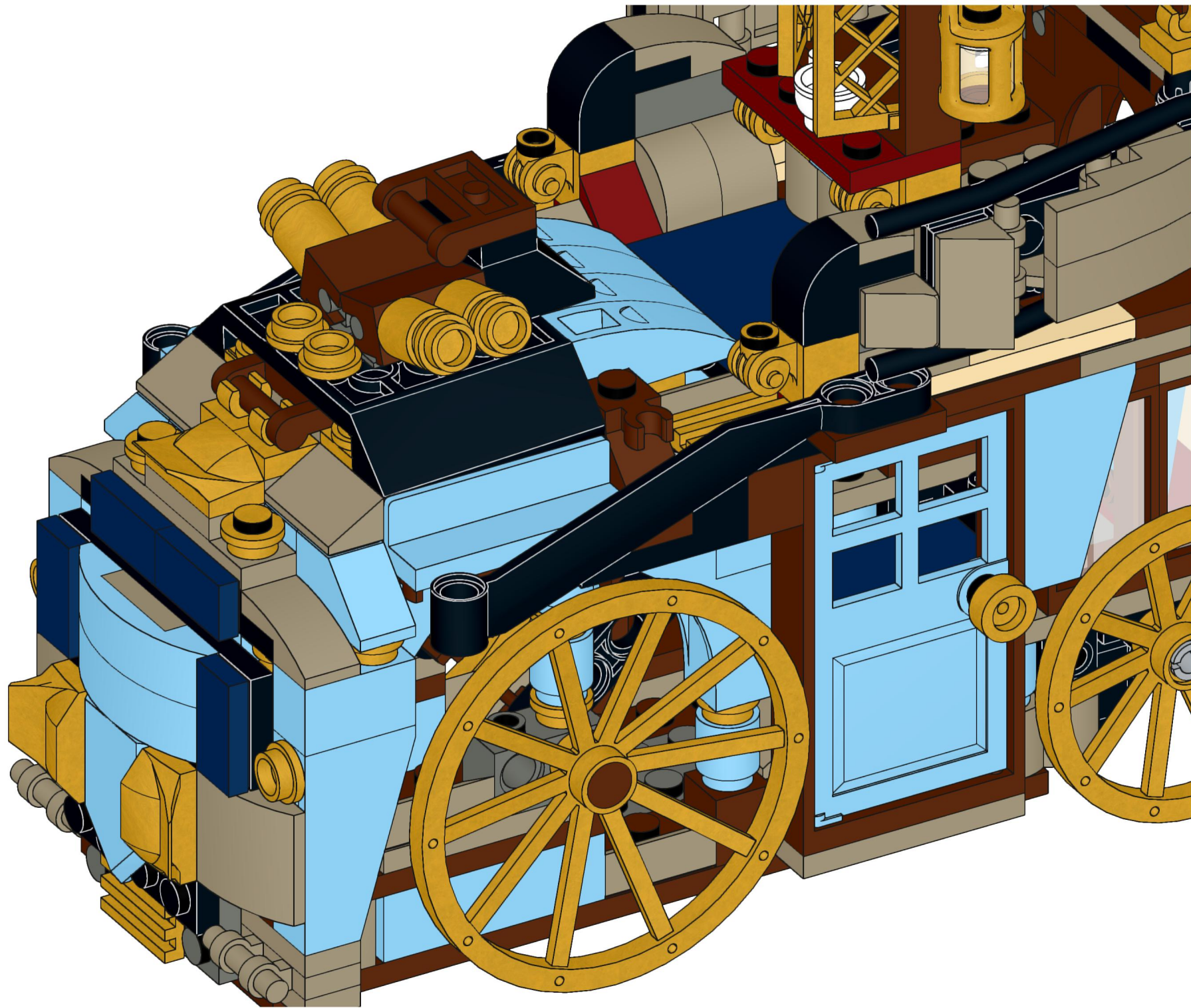

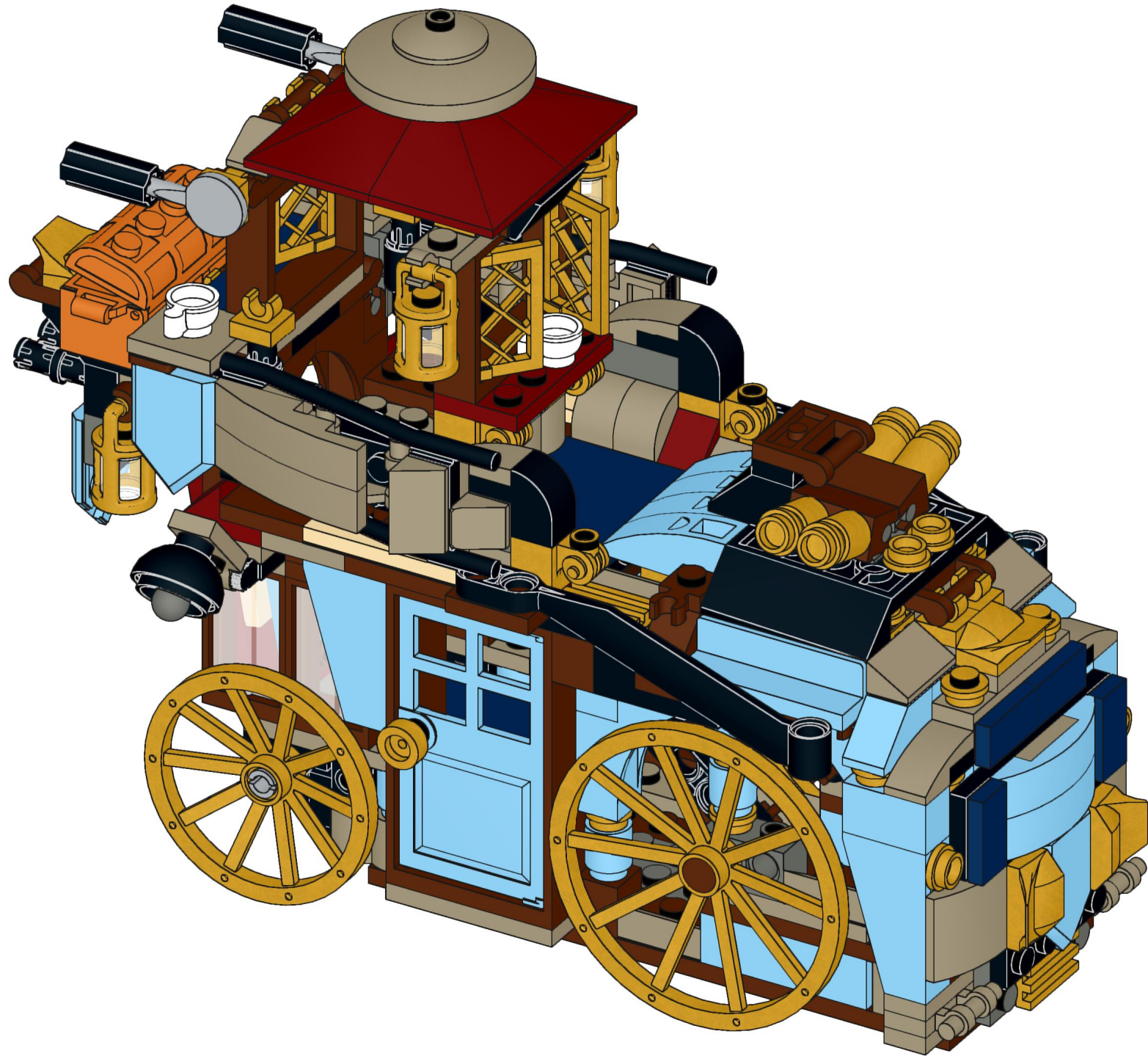

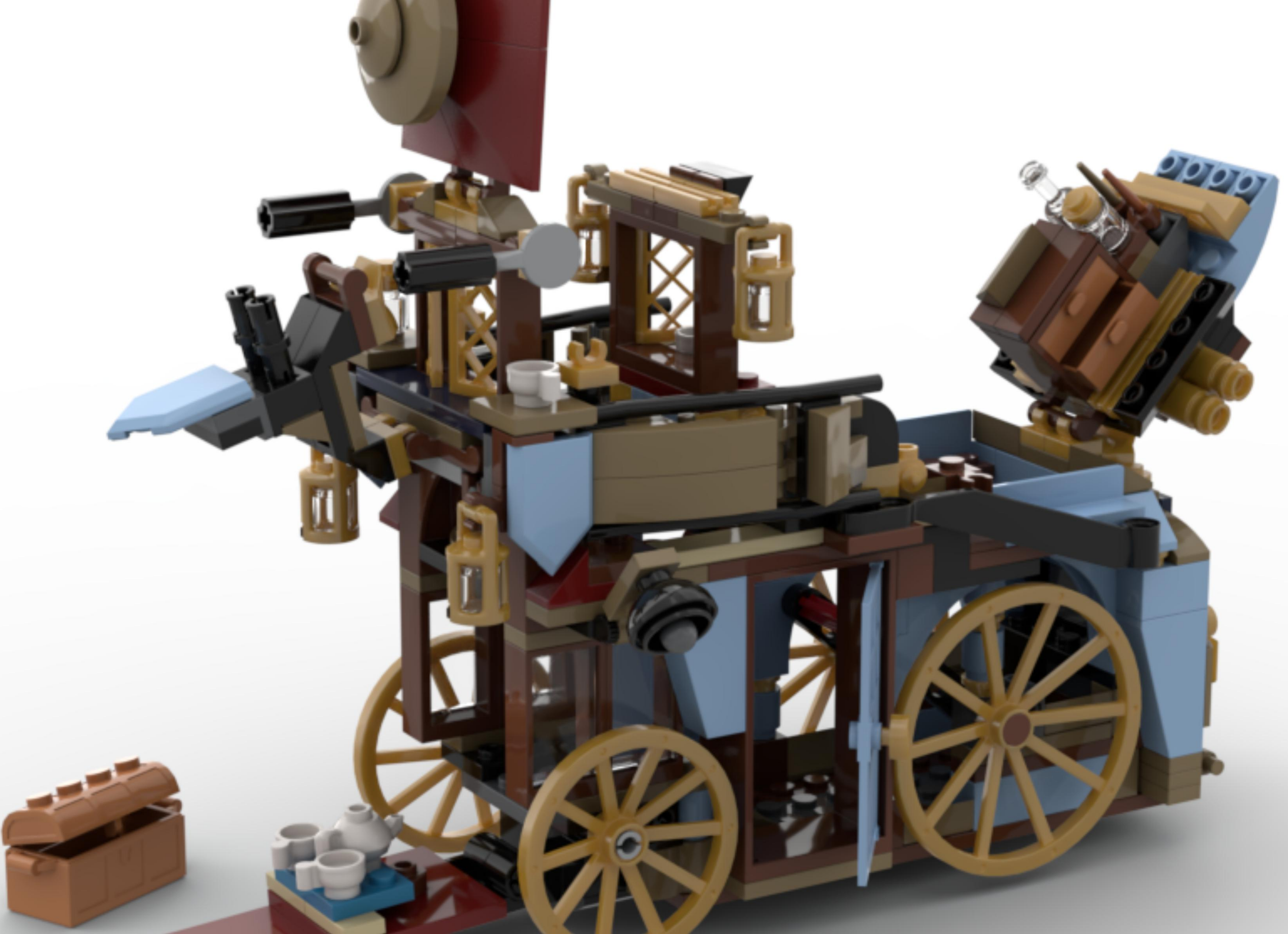



2x
x136, 11

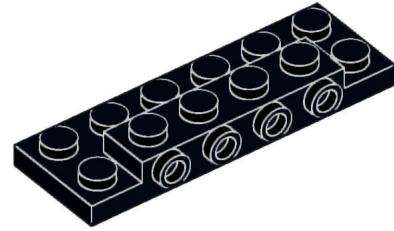

2x
87609, 11

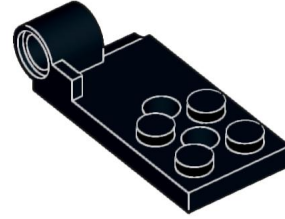

2x
43056, 11

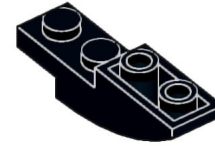

2x
13547, 11

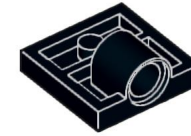

2x
10247, 11

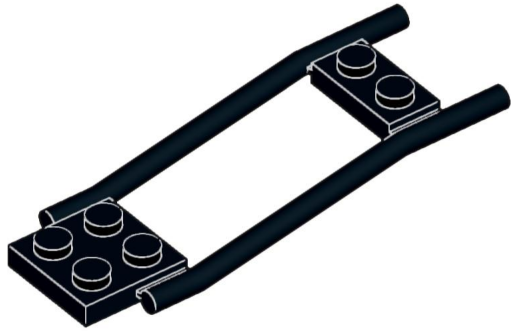

2x
2397, 11

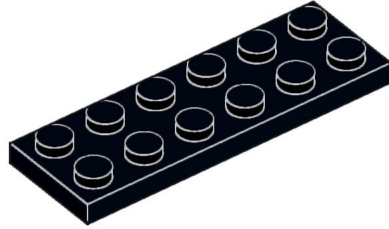

1x
3795, 11

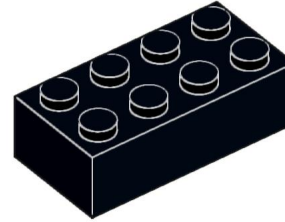

1x
3001, 11



2x
32449, 11

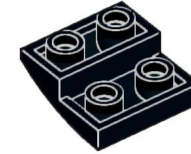

4x
32803, 11

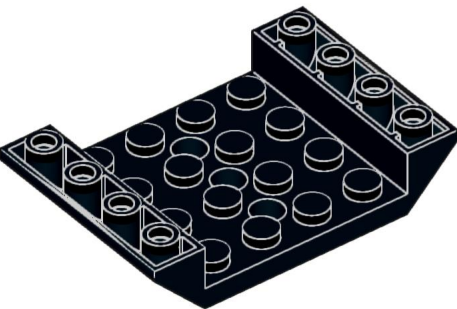

1x
60219, 11

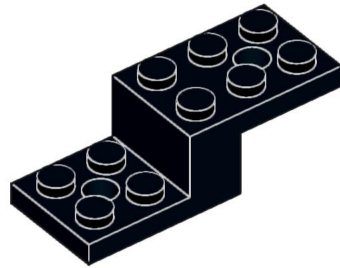

4x
11215, 11

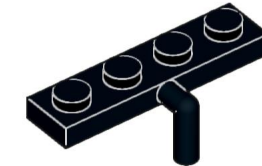

1x
30043, 11

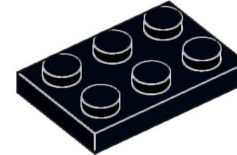

2x
3021, 11

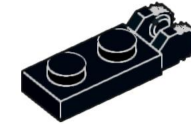

1x
44302b, 11

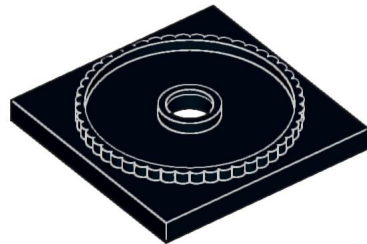

1x
61485, 11

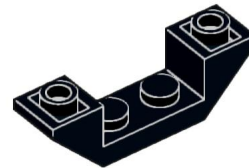

2x
32802, 11

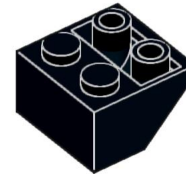

1x
3660, 11



2x
6091, 11



1x
15395, 11

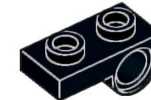

2x
18677, 11

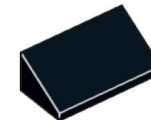

1x
85984, 11



4x
3023, 11



2x
6538c, 11



5x
2780, 11



4x
4070, 11

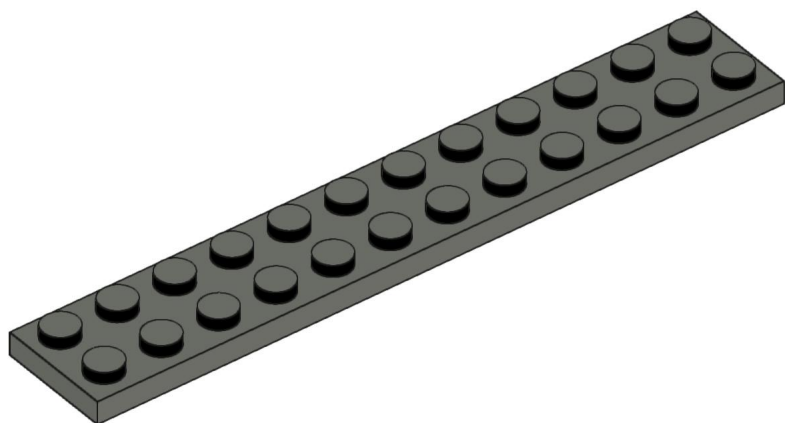

1x
2445, 85

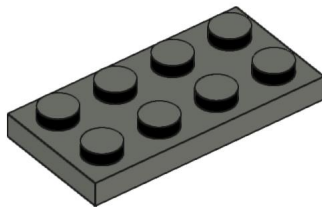

3x
3020, 85

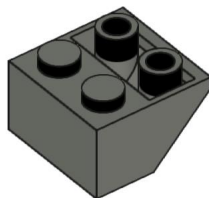

1x
3660, 85

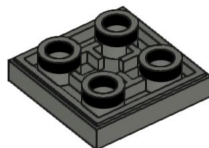

1x
11203, 85

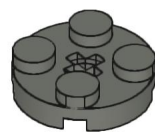

1x
4032, 85

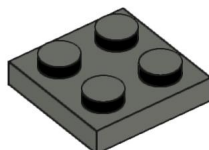

2x
3022, 85

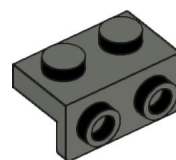

1x
99781, 85

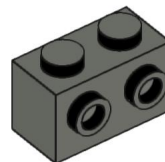

4x
11211, 85

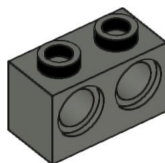

2x
32000, 85



4x
3938, 85



1x
22484, 85

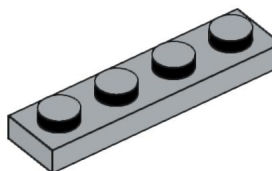

1x
3710, 86

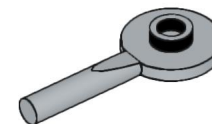

2x
3900, 86

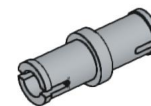

2x
3673, 86

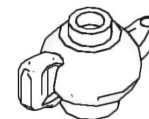

1x
23986, 1



4x
38014, 1

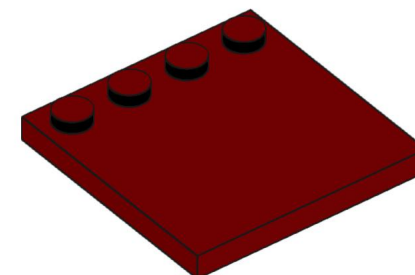

2x
6179, 59

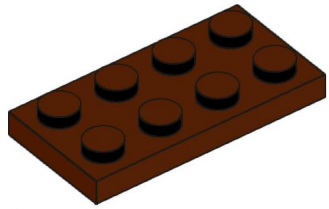

2x
3020, 88

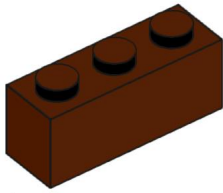

1x
3622, 88

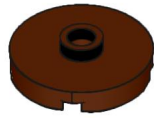

1x
18674, 88



1x
35480, 88

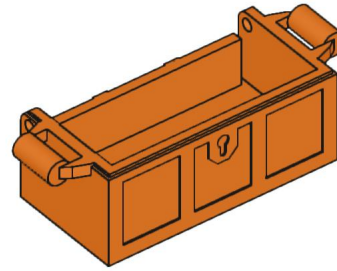

1x
4738a, 150

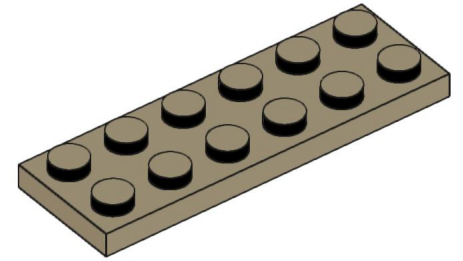

1x
3795, 69

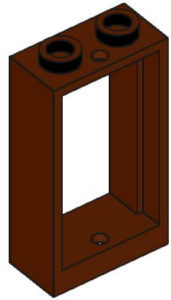

4x
60593, 88

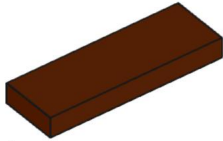

1x
63864, 88

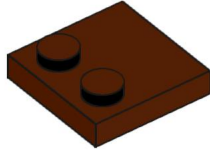

2x
33909, 88

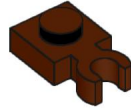

8x
4085d, 88

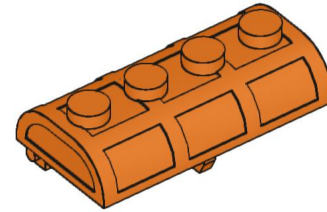

1x
4739a, 150

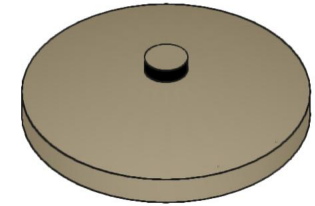

1x
3960, 69

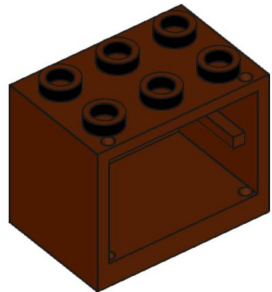

1x
4532, 88

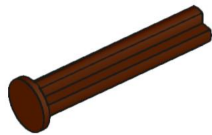

2x
24316, 88

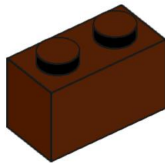

4x
3004, 88

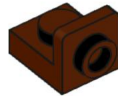

4x
36840, 88

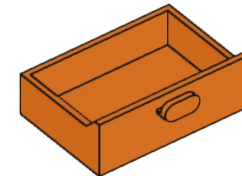

2x
4536, 150

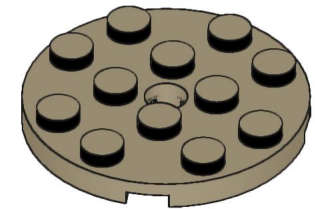

1x
60474, 69

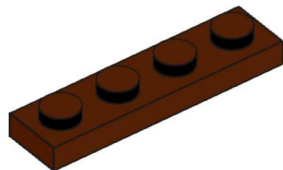

1x
3710, 88

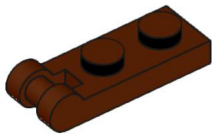

2x
60478, 88

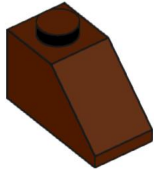

2x
3040, 88

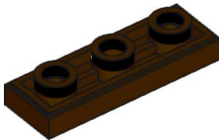

1x
35459, 120

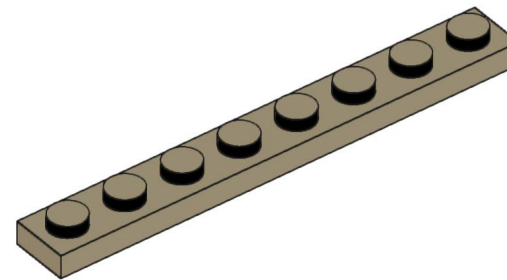

1x
3460, 69

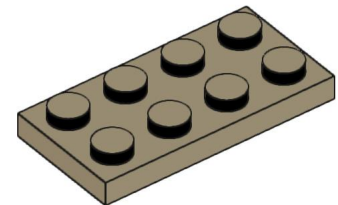

3x
3020, 69

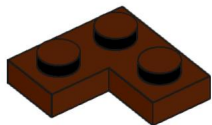

4x
2420, 88

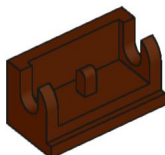

4x
3937, 88



1x
36752a, 68

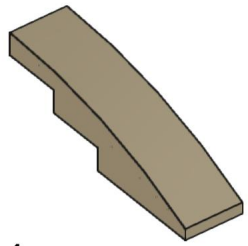

4x
61678, 69

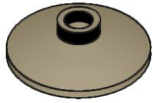

1x
4740, 69

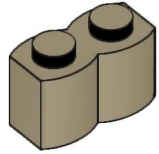

8x
30136, 69

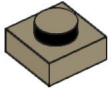

1x
3024, 69

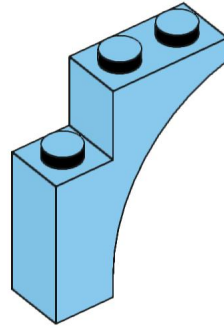

4x
13965, 105

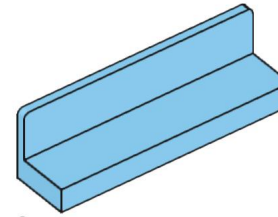

2x
30413, 105

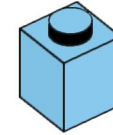

4x
3005, 105

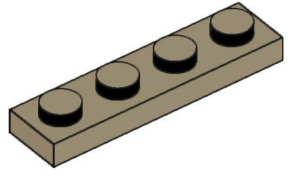

5x
3710, 69

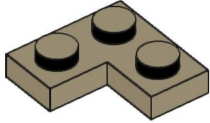

3x
2420, 69



1x
36752a, 69

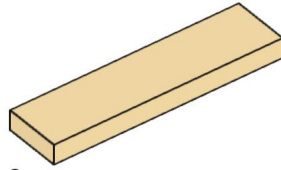

2x
2431, 2

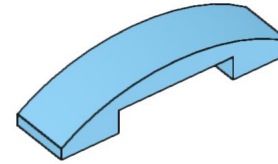

2x
93273, 105



8x
3062b, 105

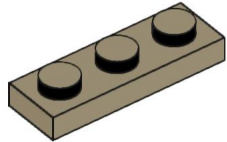

2x
3623, 69

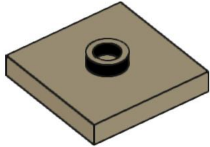

3x
87580, 69

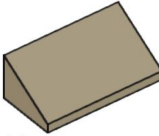

12x
85984, 69

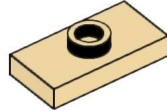

2x
15573, 2

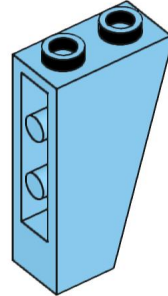

4x
2449, 105

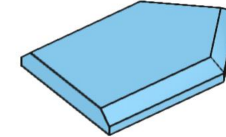

4x
22385, 105

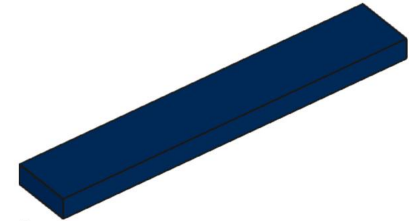

1x
6636, 63

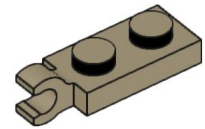

3x
63868, 69

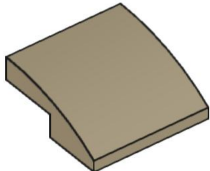

3x
15068, 69

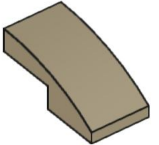

4x
11477, 69

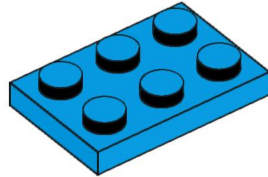

1x
3021, 153

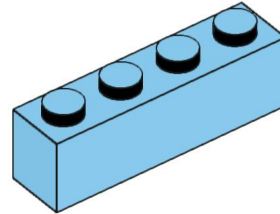

5x
3010, 105

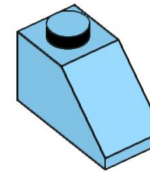

2x
3040, 105

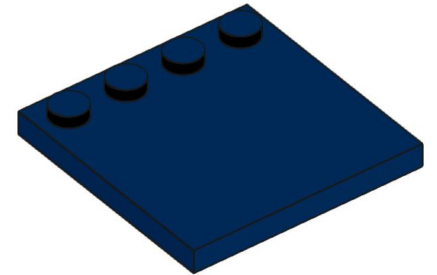

1x
6179, 63

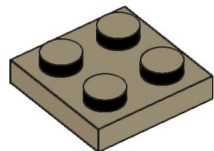

1x
3022, 69

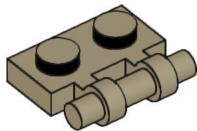

6x
2540, 69

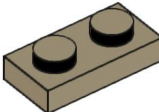

8x
3023, 69

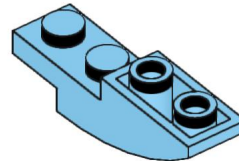

4x
13547, 105

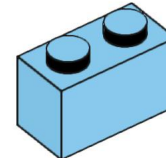

2x
3004, 105

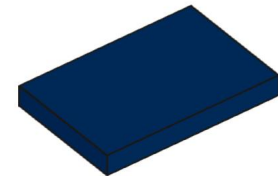

2x
26603, 63

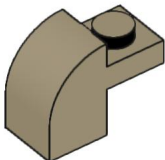

4x
6091, 69



4x
54200, 69



2x
60623, 105

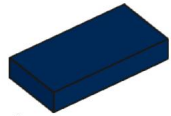

4x
3069b, 63

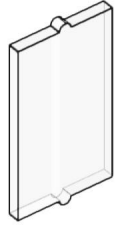

4x
60602, 12



1x
95228, 12



6x
3062b, 12

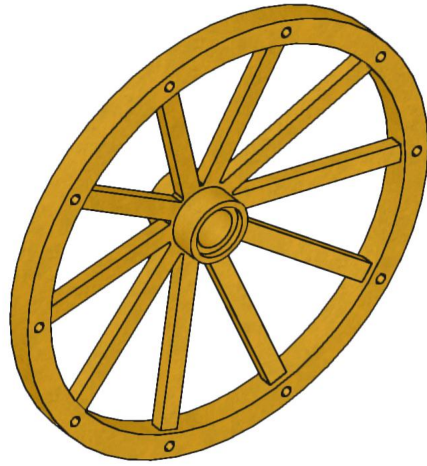

2x
33212, 115

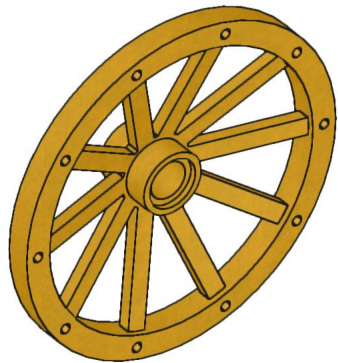

2x
33211, 115

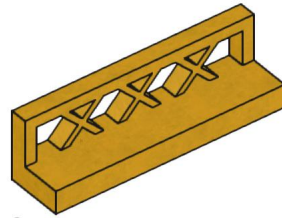

2x
3633, 115

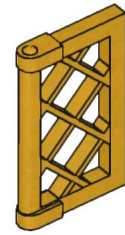

4x
60607, 115



4x
37776, 115



4x
47458, 115

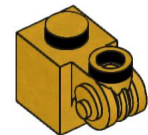

4x
20310, 115

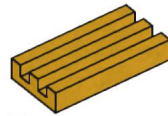

7x
2412b, 115



4x
3062b, 115



10x
15712, 115



2x
20482, 115



24x
4073, 115